

# Jarret Structures is Your Partner

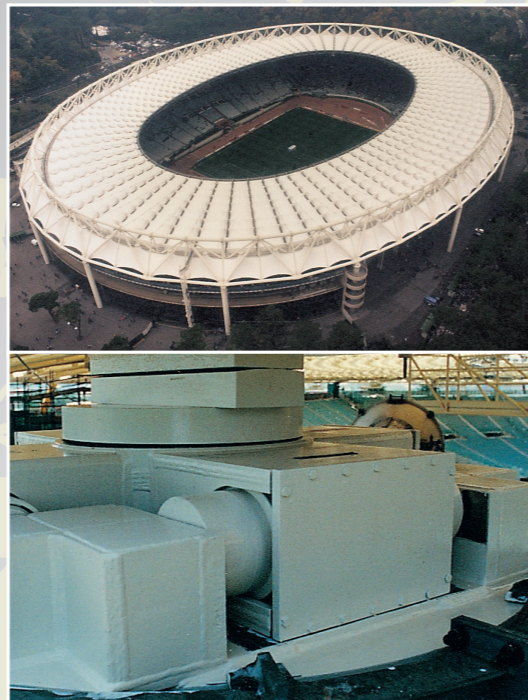

## Rome Olympic Stadium (Italy)

- Spring shock absorbers connecting the metal roof to the columns,
- to absorb thermal expansion/contraction
  - to block and transmit the forces generated by high winds (F = 1000 kN, C = ± 180 mm,  $\sigma$  = 150 mm)

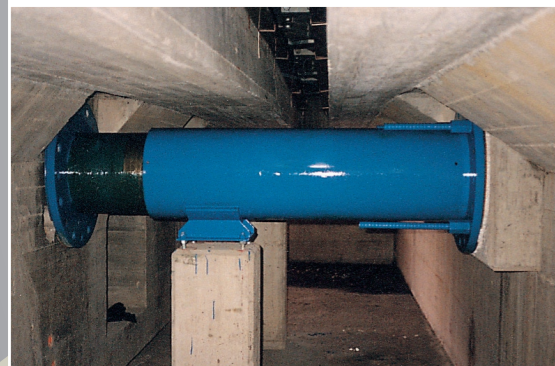

## Restello (Italy)

Spring shock absorbers installed at the abutments  
(F = 6000 kN, C = 600 mm)  $\sigma$  600 mm

JARRET // STRUCTURES

[www.jarretstructures.com](http://www.jarretstructures.com)

73 Avenue Charles de Gaulle  
95700 Roissy en France - FRANCE  
Tél.: +33 / (0) 3 22 74 31 08 - Fax : +33 / (0) 3 22 74 78 43  
E-mail: [afleroy@jarretstructures.com](mailto:afleroy@jarretstructures.com)

JARRET // STRUCTURES

PROTECTION OF STRUCTURES



# Study and Analysis

JARRET STRUCTURES engineers have developed highly effective solutions by creating energy absorbing devices satisfying technical requirements related to structural characteristics, response spectra and maximum allowable acceleration.

In this respect, two software programs based on time history analysis, have been specially created to ensure the best possible protection through the optimization of the force-displacement characteristics of the energy absorbing devices.

## POINTE À PITRE (Guadeloupe)

Raizet airport access viaduct  
Seismic protection through the installation of 28 shock absorbers mounted in various combinations.  
(F = 880 kN, C = ± 105 mm,  $\phi$  = 180 mm)

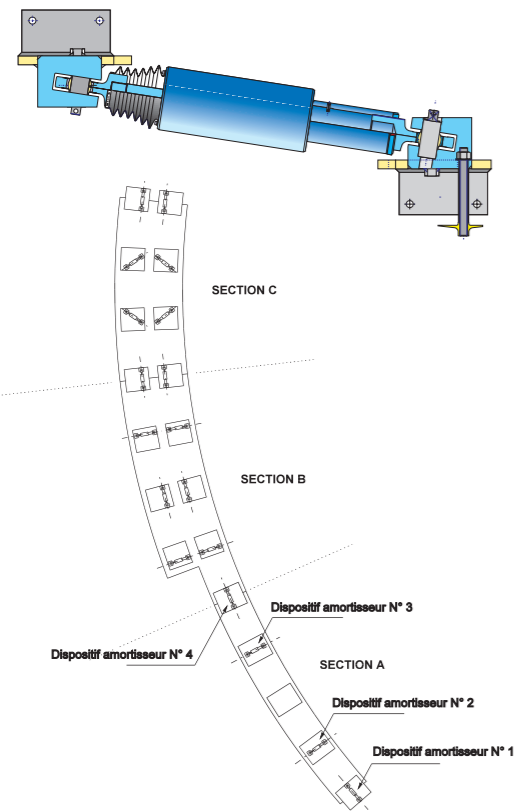

## LABORATORY TESTING

Shock absorber undergoing forced vibration testing at the L.C.P.C. in Nantes (France).

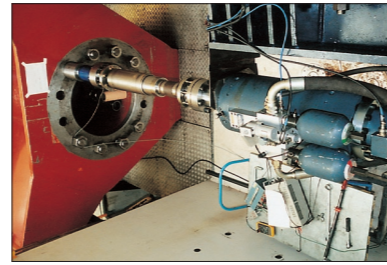

Very important for JARRET STRUCTURES systems, the area of the "force/stroke" curve determines the energy capacity of the device.

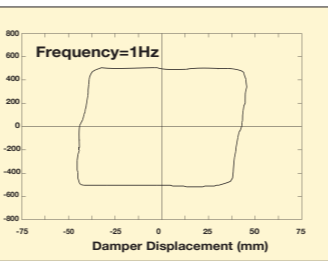
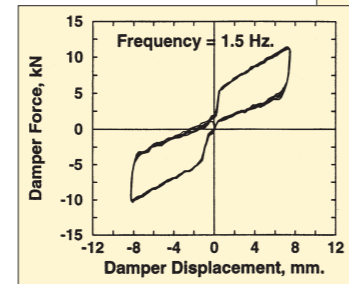

Actual performance curve of a spring-shock absorber tested at the State University of New York (SUNY) at Buffalo.

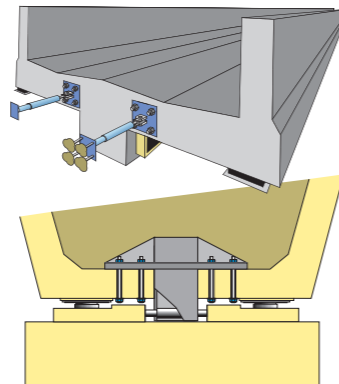
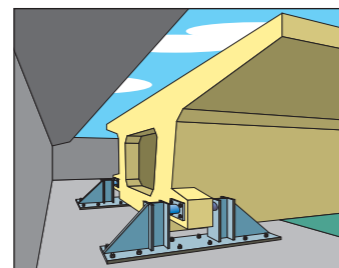

## CIVIL STRUCTURES

No matter what type of structure, bridge or viaduct, JARRET STRUCTURES has created shock absorbers which dissipate a large part of the kinetic energy, reducing the displacement of the deck and minimizing the forces on the abutments and supporting columns.

Installation of spring-shock absorbers allows the creation of a virtual longitudinal fixed point on the abutment and a transverse virtual fixed point on the pile.

## Brest (France)

### Iroise Bridge

Protection against lateral wind loading and traffic loads by the installation of 8 vertically mounted shock absorbers.  
(F = 250 kN, C = ± 160 mm,  $\phi$  = 170 mm)

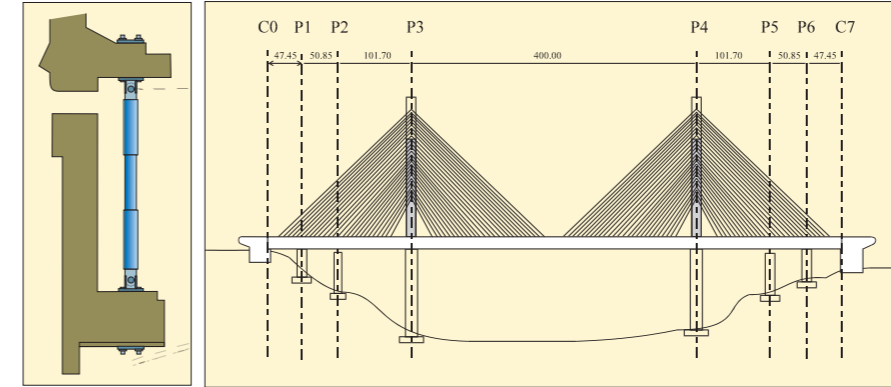

Principal dimensions of the Iroise Bridge

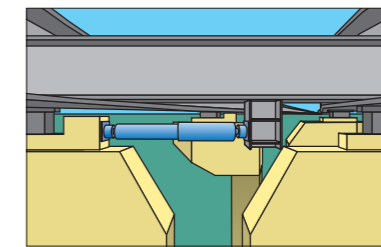
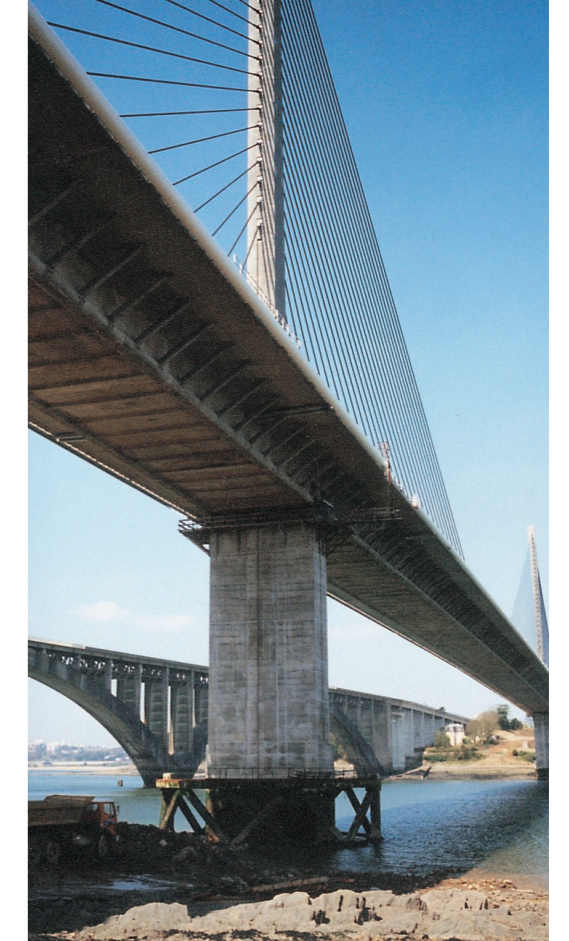

## A43 - Aiton viaduct (France)

Longitudinal protection achieved by the installation of shock absorbers at the abutments. Lateral protection achieved by the installation of shock absorbers at the piles.  
(F = 500 kN, C = ± 130 mm,  $\phi$  = 180 mm)

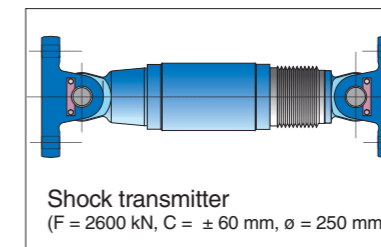

Shock transmitter  
(F = 2600 kN, C = ± 60 mm,  $\phi$  = 250 mm)

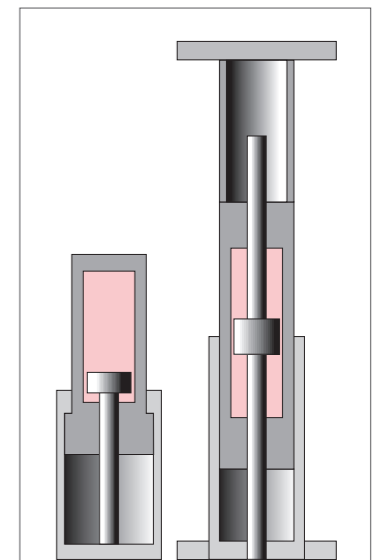

Cross sections of a spring shock absorber and shock absorber.

## BUILDINGS

JARRET STRUCTURES devices are easily adapted to meet the requirements of different types of structures:

- As an energy dissipation device in a base isolation system
- The reduction of inter-story drift for flexible structures

