



ZEROCINQUE

zerocinque
il pannello che
apre e chiude
i tuoi momenti
dentro e fuori
la casa





ZERO
CINQUE

Zerocinque nasce come Società nel 2006, da un'idea dei soci fondatori, forti dell'esperienza maturata in oltre vent'anni di lavoro nel settore dei pannelli per porte di ingresso e porte blindate.

L'Azienda, che produce e commercializza pannelli ed accessori per porte blindate e serramenti in PVC, si avvale di una forza lavoro di 18 unità specializzate che, con l'utilizzo di macchinari di nuova generazione, tecnologicamente avanzati, quali: "centri di lavoro a controllo numerico, robot di verniciatura, presse a doppia membrana e spazzolatrici automatiche" ed il lavoro di finitura manuale delle bugne, sono in grado di fornire un prodotto di elevata qualità ed una gamma completa di pannelli per qualsiasi esigenza.

Ogni fase di lavorazione è curata con professionalità e grande attenzione e la scelta dei materiali più pregiati contribuisce alla qualità del prodotto finale.

Zerocinque si avvale della collaborazione di uno studio professionale per la ricerca, la sperimentazione e lo sviluppo, per garantire una presenza forte sul mercato e per soddisfare le necessità di un'utenza sempre più evoluta ed attenta ai cambiamenti del nostro tempo.



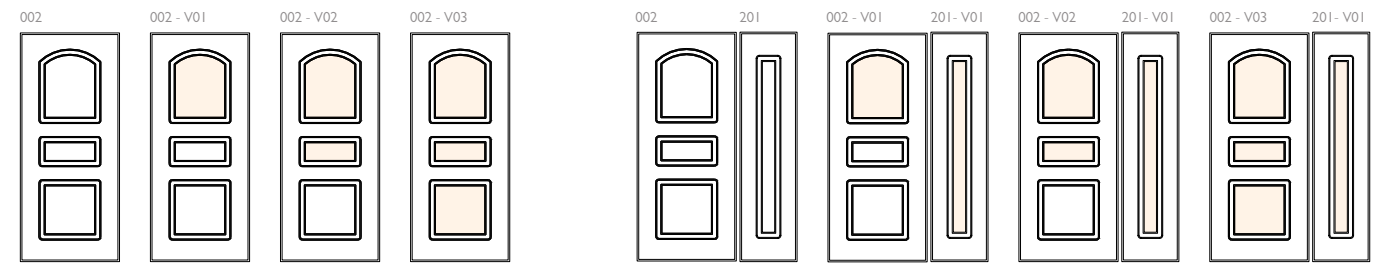

002

Modello realizzato con HDF idrorepellenti e rifiniti con pellicole con superfici intelligenti. Disponibile nelle tipologie cieche e/o predisposte al vetro, oppure nelle versioni coibentate.



Particolare interno della cornice del pannello predisposto al vetro



Particolare esterno della cornice del pannello predisposto al vetro





ZER@
CINQUE

012

Modello realizzato con HDF idrorepellenti e rifiniti con pellicole con superfici intelligenti. Disponibile nelle tipologie cieche e/o predisposte al vetro, oppure nelle versioni coibentate.

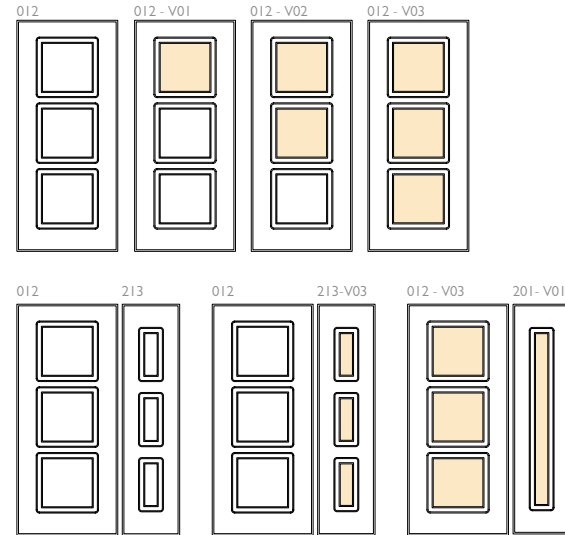

Particolare della bugna standard in bassorilievo

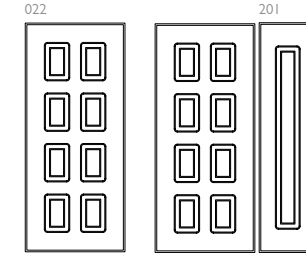

022

Modello realizzato con HDF idrorepellenti e rifiniti con pellicole con superfici intelligenti. Disponibile nelle tipologie cieche, oppure nelle versioni coibentate.



ZER@
CINQUE

Particolare della bugna standard in bassorilievo





ZER@
CINQUE

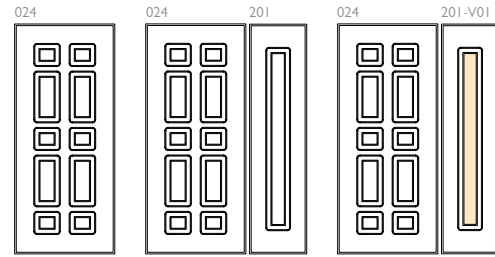

024

Modello realizzato con HDF idrorepellenti e rifiniti con pellicole con superfici intelligenti. Disponibile nelle tipologie cieche, oppure nelle versioni coibentate.

Particolare della bugna standard in bassorilievo



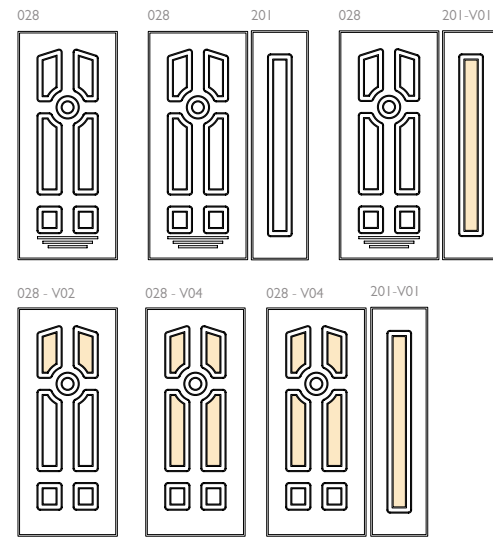

028

Modello realizzato con HDF idrorepellenti e rifiniti con pellicole con superfici intelligenti. Disponibile nelle tipologie cieche e/o predisposte al vetro, oppure nelle versioni coibentate.

Particolare della bugna standard in bassorilievo



Particolare della bugna standard in bassorilievo



034

Modello realizzato con HDF idrorepellenti e rifiniti con pellicole con superfici intelligenti. Disponibile nelle tipologie cieche e/o predisposte al vetro, oppure nelle versioni coibentate.

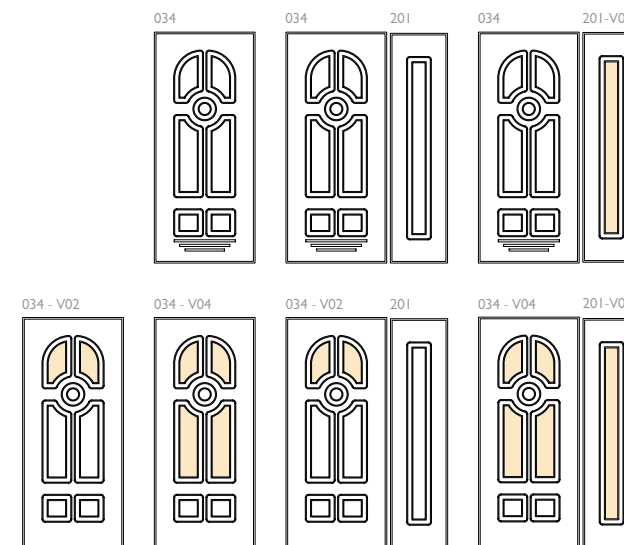



ZER
CINQUE



ZER
CINQUE



035

Modello realizzato con HDF idrorepellenti e rifiniti con pellicole con superfici intelligenti. Disponibile nelle tipologie cieche, oppure nelle versioni coibentate.

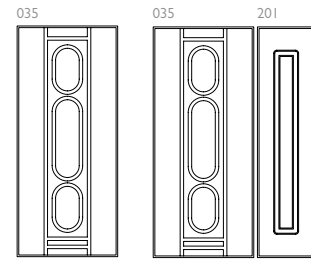

Particolare della bugna ribassata da 30 mm

038

Modello realizzato con HDF idrorepellenti e rifiniti con pellicole con superfici intelligenti. Disponibile nelle tipologie cieche, oppure nelle versioni coibentate.

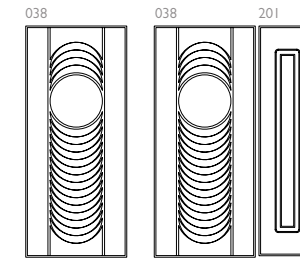

Particolare della dogia da 10 mm



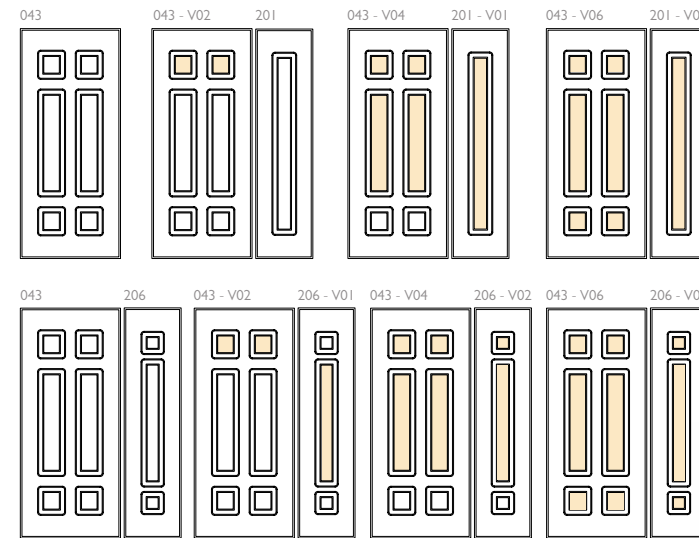

043

Modello realizzato con HDF idrorepellenti e rifiniti con pellicole con superfici intelligenti. Disponibile nelle tipologie cieche e/o predisposte al vetro, oppure nelle versioni coibentate.

Particolare della bugna standard in bassorilievo





ZER@
CINQUE

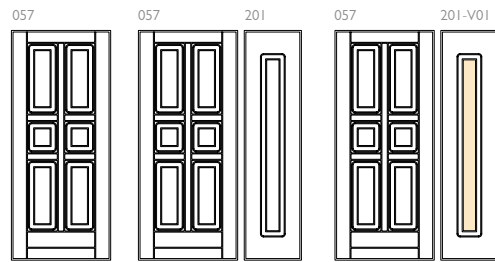

057

Modello realizzato con HDF idrorepellenti e rifiniti con pellicole con superfici intelligenti. Disponibile nelle tipologie cieche, oppure nelle versioni coibentate.

Particolare della bugna standard in bassorilievo con doga da 10 mm





ZER@
CINQUE



ZER@
CINQUE



070

Modello realizzato con bugna
riportata "tipo S" in HDF exterior.
Disponibile nelle tipologie cieche,
oppure nelle versioni coibentate.

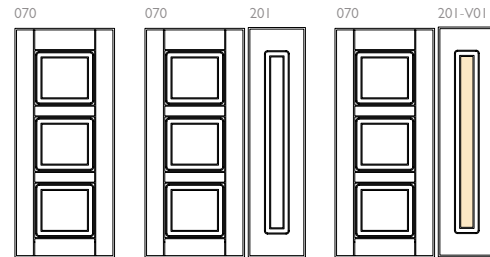

Particolare della bugna tipo massello "OS"



I modelli che si possono realizzare con bugna riportata:

002 - 003 - 006 - 007 - 010 - 012 - 013 - 014
015 - 022 - 023 - 024 - 026 - 027 - 029 - 034
040 - 043 - 044 - 046 - 048 - 049 - 050 - 051
052 - 053 - 056 - 057 - 058 - 059 - 066 - 068
069 - 070 - 085 - 086 - 087 - 091 - 093 - 094
095 - 098 - 102 - 103 - 107 - 113 - 114 - 118
127 - 128 - 148 - 151 - 161 - 162 - 163 - 175

201 - 202 - 203 - 204 - 205 - 206 - 207 - 208 - 209



Particolare lavorazione 3D in bassorilievo



Particolare lavorazione 3D in altorilievo



ZER@
CINQUE



ZER@
CINQUE

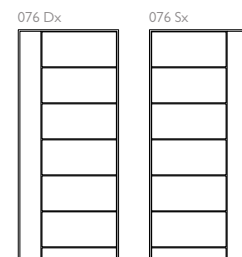

076

Modello realizzato con HDF idrorepellenti e rifiniti con pellicole con superfici intelligenti. Disponibile nelle tipologie cieche, oppure nelle versioni coibentate.

Particolare della bugna ribassata da 30 mm in bassorilievo

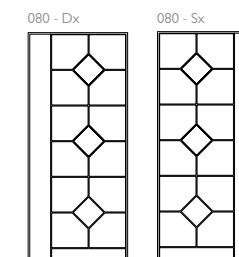

080

Modello realizzato con HDF idrorepellenti e rifiniti con pellicole con superfici intelligenti. Disponibile nelle tipologie cieche, oppure nelle versioni coibentate.

Particolare della bugna ribassata da 30 mm in rilievo



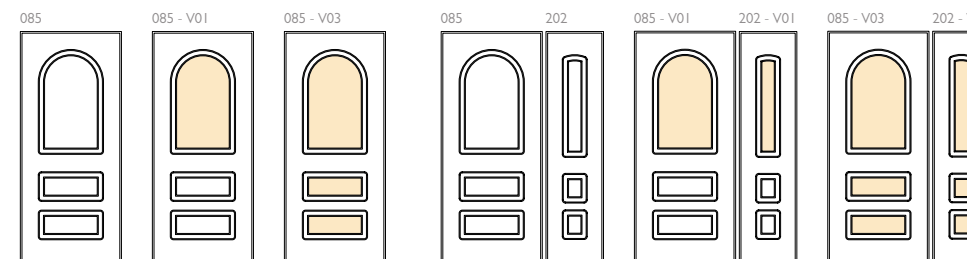

085

Modello realizzato con HDF idrorepellenti e rifiniti con pellicole con superfici intelligenti. Disponibile nelle tipologie cieche e/o predisposte al vetro, oppure nelle versioni coibentate.



Pannello predisposto al vetro lato interno



Pannello cieco con cornice a rilievo



Anta stretta in bassorilievo



ZER@
CINQUE

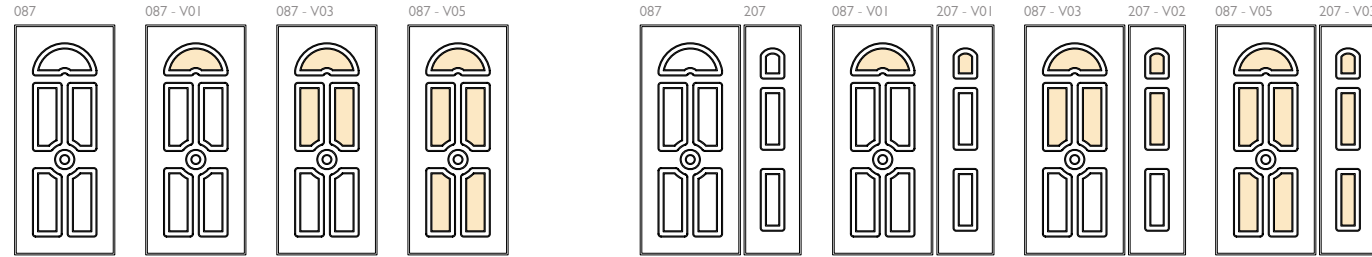

Pannello tipo "O" lato interno



Pannello tipo "O" lato esterno

087

Modello realizzato con HDF idrorepellenti e rifiniti con pellicole con superfici intelligenti. Disponibile nelle tipologie cieche e/o predisposte al vetro, oppure nelle versioni coibentate.

Particolare tipo "O" lato esterno





ZER@
CINQUE



Pannello tipo "M"



Pannello tipo "ON" lato esterno

088

Modello realizzato con HDF idrorepellenti e rifiniti con pellicole con superfici intelligenti. Disponibile nelle tipologie cieche e/o predisposte al vetro, oppure nelle versioni coibentate.

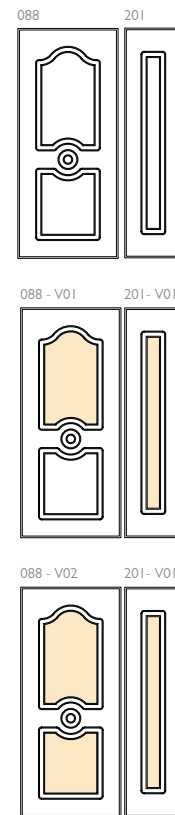

089



Modello realizzato con HDF idrorepellenti e rifiniti con pellicole con superfici intelligenti. Disponibile nelle tipologie cieche, oppure nelle versioni coibentate.

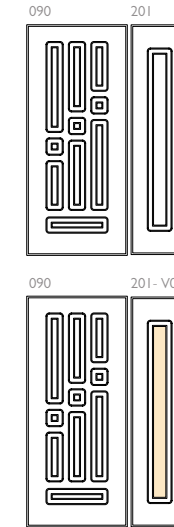

Modello realizzato con HDF idrorepellenti e rifiniti con pellicole con superfici intelligenti. Disponibile nelle tipologie cieche e/o predisposte al vetro, oppure nelle versioni coibentate.

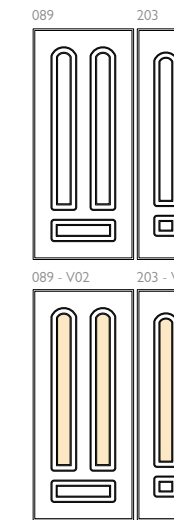

090



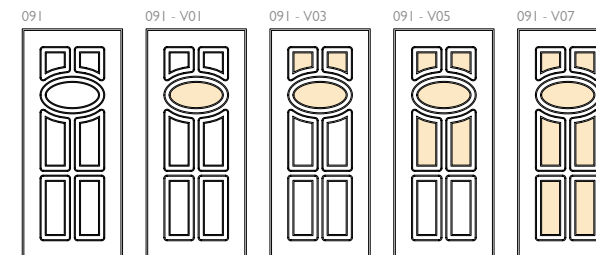

091

Modello realizzato con HDF idrorepellenti e rifiniti con pellicole con superfici intelligenti. Disponibile nelle tipologie cieche e/o predisposte al vetro, oppure nelle versioni coibentate.

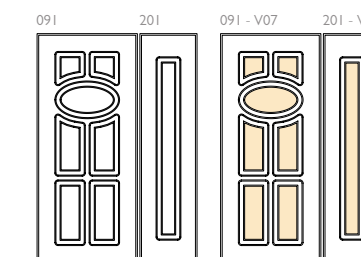



Particolare della bugna standard in bassorilievo

092

Modello realizzato con HDF idrorepellenti e rifiniti con pellicole con superfici intelligenti. Disponibile nelle tipologie cieche, oppure nelle versioni coibentate.

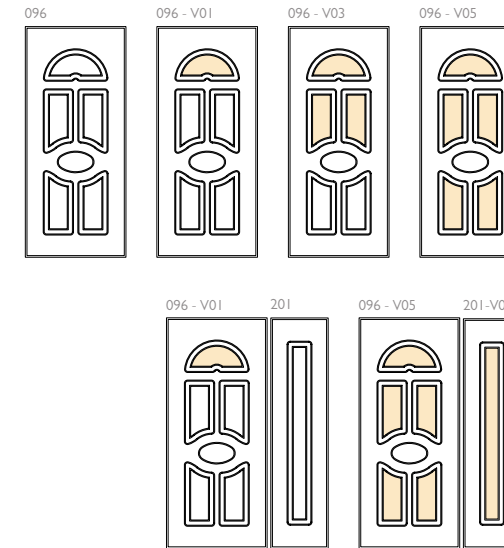
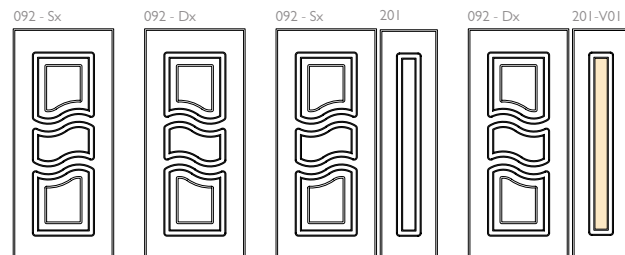

096

Modello realizzato con HDF idrorepellenti e rifiniti con pellicole con superfici intelligenti. Disponibile nelle tipologie cieche e/o predisposte al vetro, oppure nelle versioni coibentate.

Particolare della doppia lavorazione; parte centrale con bugna ribassata da 30 mm





ZER@
CINQUE



ZER@
CINQUE

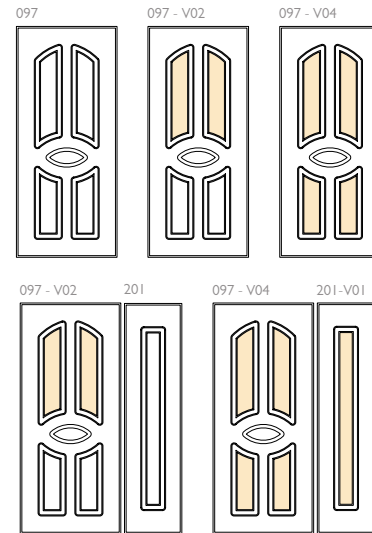

097

Modello realizzato con HDF idrorepellenti e rifiniti con pellicole con superfici intelligenti. Disponibile nelle tipologie cieche e/o predisposte al vetro, oppure nelle versioni coibentate.

Particolare della bugna standard in bassorilievo

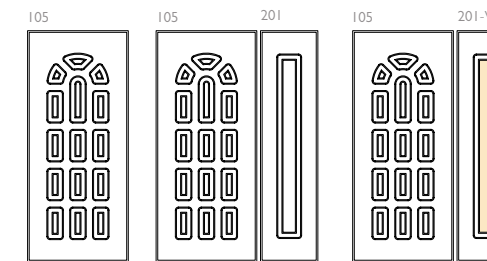

105

Modello realizzato con HDF idrorepellenti e rifiniti con pellicole con superfici intelligenti. Disponibile nelle tipologie cieche, oppure nelle versioni coibentate.

Particolare della lavorazione



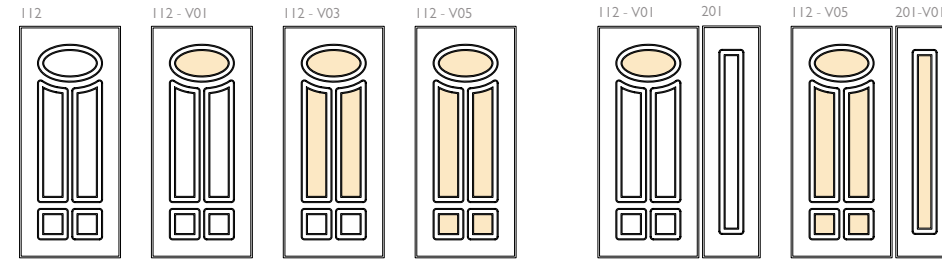

112

Modello realizzato con HDF idrorepellenti e rifiniti con pellicole con superfici intelligenti. Disponibile nelle tipologie cieche e/o predisposte al vetro, oppure nelle versioni coibentate.

Particolare della bugna standard in bassorilievo





ZER@
CINQUE

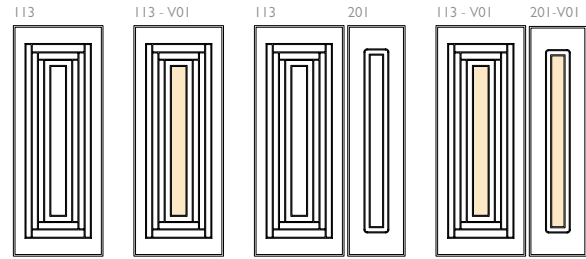
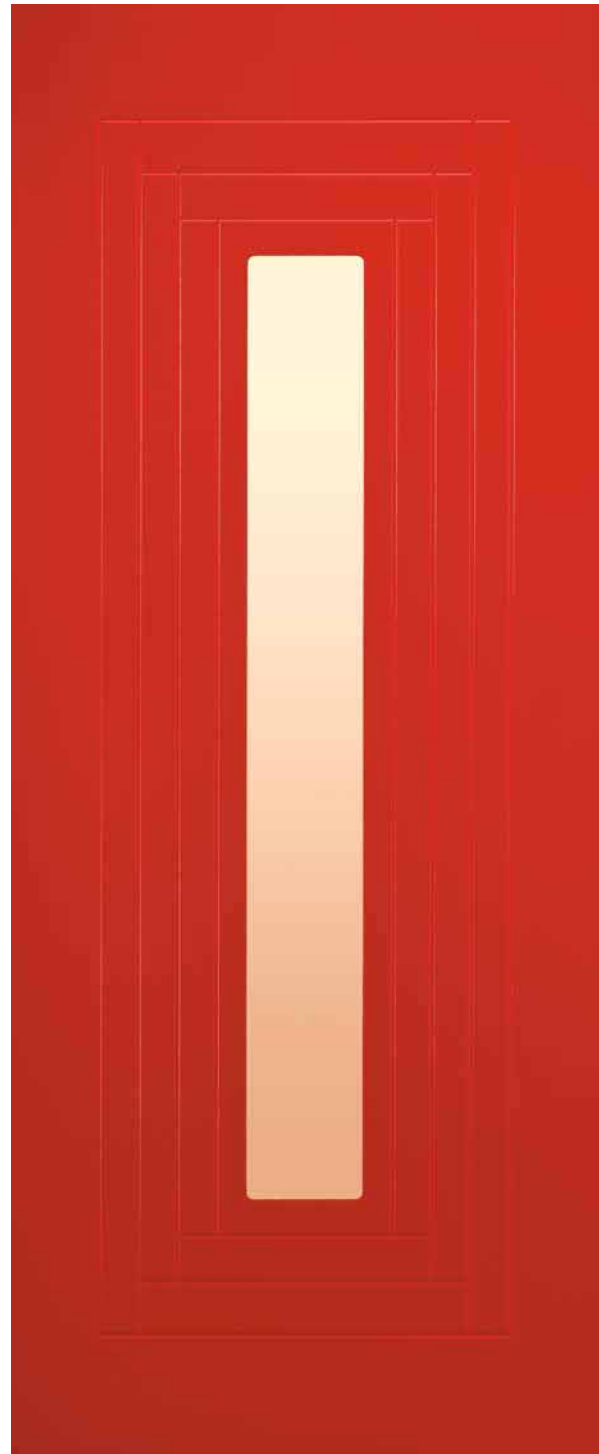

113

Modello realizzato con HDF idrorepellenti e rifiniti con pellicole con superfici intelligenti. Disponibile nelle tipologie cieche e/o predisposte al vetro, oppure nelle versioni coibentate.

Particolare della doga da 10 mm in bassorilievo



Particolare della bugna ribassata da 30 mm in bassorilievo

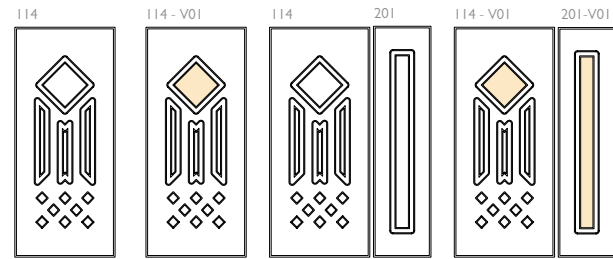

114

Modello realizzato con HDF idrorepellenti e rifiniti con pellicole con superfici intelligenti. Disponibile nelle tipologie cieche e/o predisposte al vetro, oppure nelle versioni coibentate.





ZER@
CINQUE



124

Modello realizzato con HDF idrorepellenti e rifiniti con pellicole con superfici intelligenti. Disponibile nelle tipologie cieche, oppure nelle versioni coibentate.

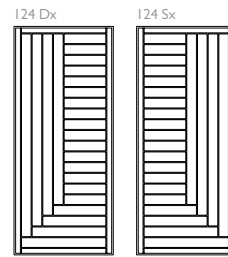

Particolare della doga da 10 mm in bassorilievo



123



Modello realizzato con HDF idrorepellenti e rifiniti con pellicole con superfici intelligenti. Disponibile nelle tipologie cieche, oppure nelle versioni coibentate.

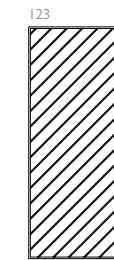

125



Modello realizzato con HDF idrorepellenti e rifiniti con pellicole con superfici intelligenti. Disponibile nelle tipologie cieche, oppure nelle versioni coibentate.

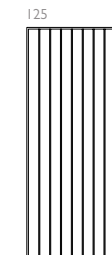

ZER@
CINQUE

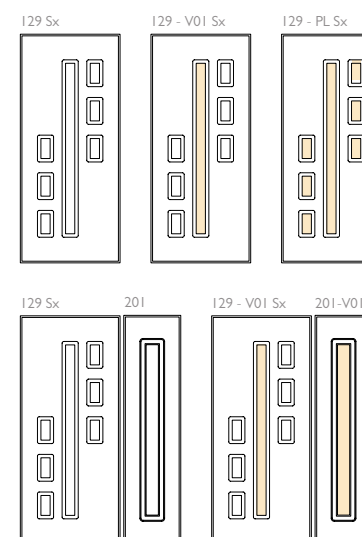

Particolare finitura rame + alluminio



129

Modello con inserti colorati tipo rame e alluminio, realizzato in HDF exterior. Le combinazioni cromatiche si possono scegliere nel nostro campionario.





ZER@
CINQUE



ZER@
CINQUE

I29 V-01 LED

Modello realizzato con HDF idrorepellenti e rifiniti con pellicole con superfici intelligenti. Disponibile nella sola versione vetrabile, con inserti Led Monocromatici (Bianchi) oppure Multicolor.

I29 - V01 Sx

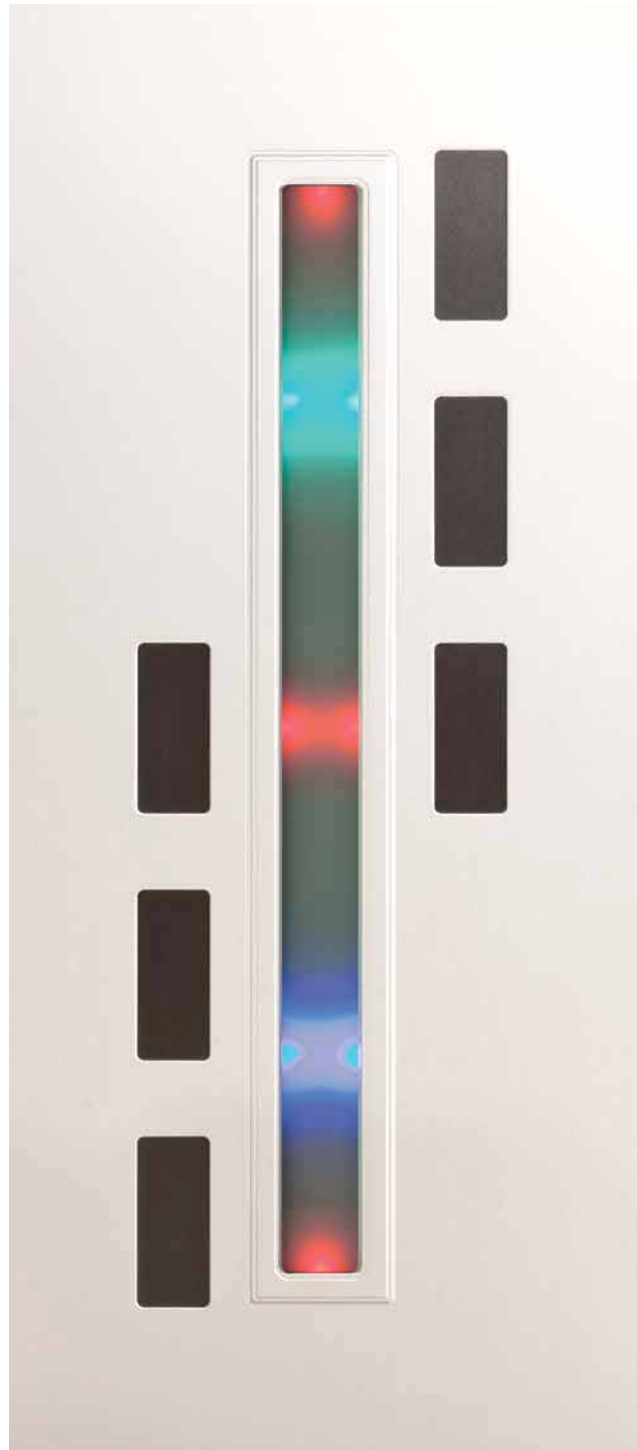
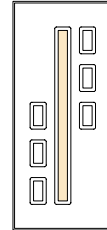

Particolare interno

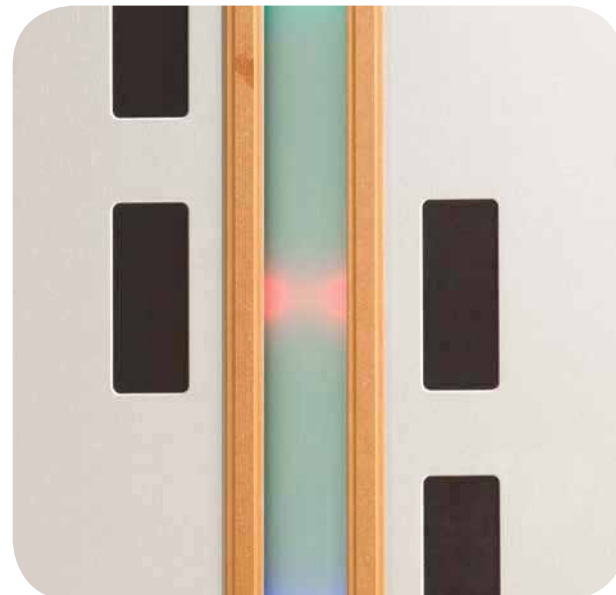

Particolare lato interno



Particolare con LED accesi con inserti colorati





ZER@
CINQUE



ZER@
CINQUE

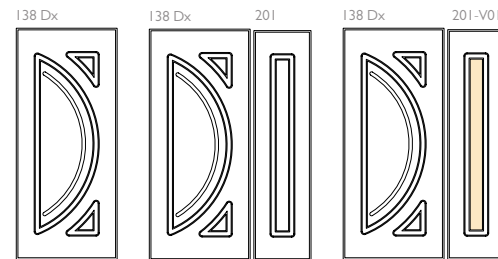

138

Modello realizzato con HDF idrorepellenti e rifiniti con pellicole con superfici intelligenti. Disponibile nelle tipologie cieche e/o predisposte al vetro, oppure nelle versioni coibentate.



Particolare della bugna standard in bassorilievo

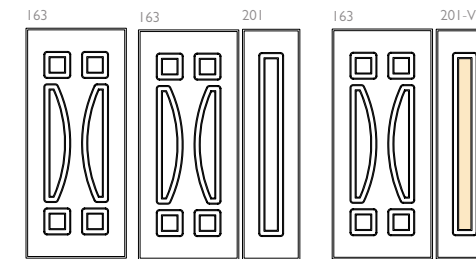

163

Modello realizzato con HDF idrorepellenti e rifiniti con pellicole con superfici intelligenti. Disponibile nelle tipologie cieche, oppure nelle versioni coibentate.



Particolare della bugna standard in bassorilievo





ZER@
CINQUE



167

Modello realizzato con HDF idrorepellenti e rifiniti con pellicole con superfici intelligenti. Disponibile nelle tipologie cieche, oppure nelle versioni coibentate.

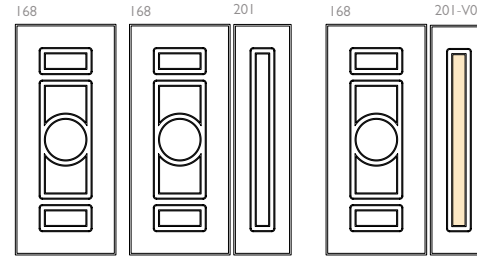
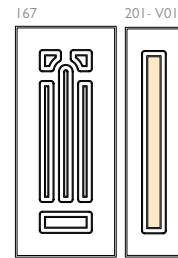
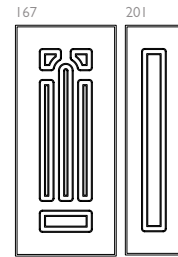

168

Modello realizzato con HDF idrorepellenti e rifiniti con pellicole con superfici intelligenti. Disponibile nelle tipologie cieche, oppure nelle versioni coibentate.

Particolare della bugna standard in bassorilievo





Particolare degli inserti colorati in rosso e giallo

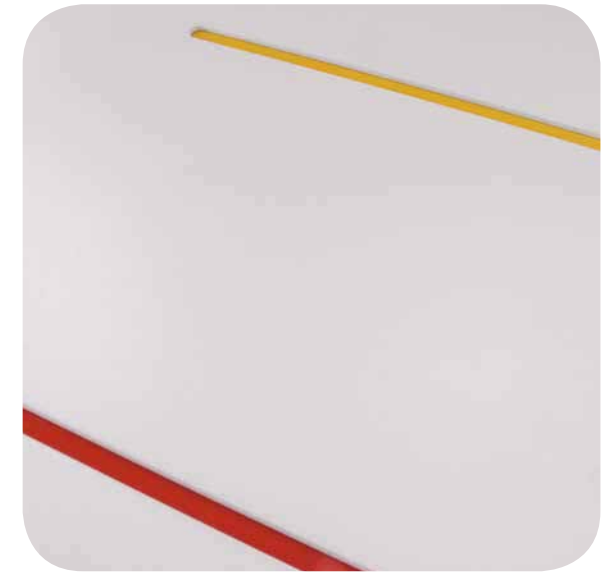

172

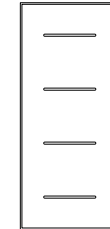

172

Modello realizzato con HDF idrorepellenti e rifiniti con pellicole con superfici intelligenti. Disponibile nelle tipologie cieche, oppure nelle versioni coibentate. Le combinazioni cromatiche si possono scegliere nel nostro campionario.





ZER@
CINQUE

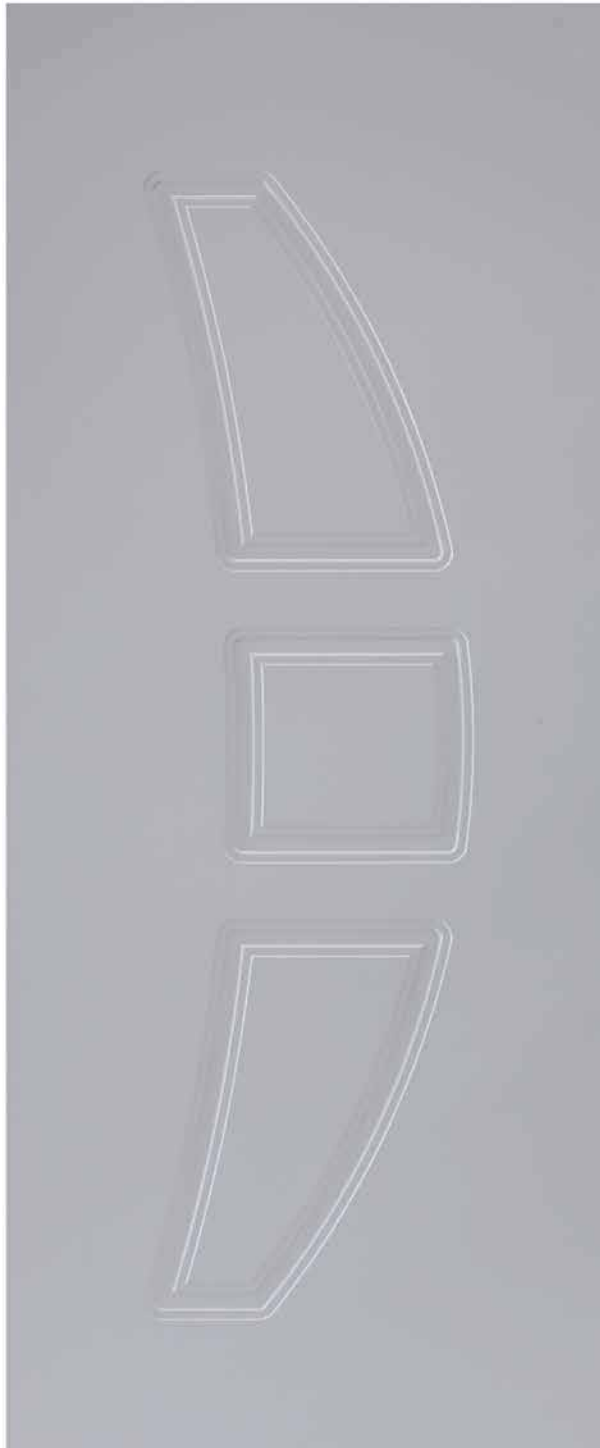

173

Modello realizzato con HDF idrorepellenti e rifiniti con pellicole con superfici intelligenti. Disponibile nelle tipologie cieche e/o predisposte al vetro, oppure nelle versioni coibentate.

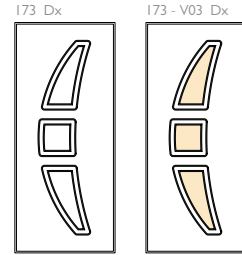

Particolare della bugna standard in bassorilievo



ZER@
CINQUE

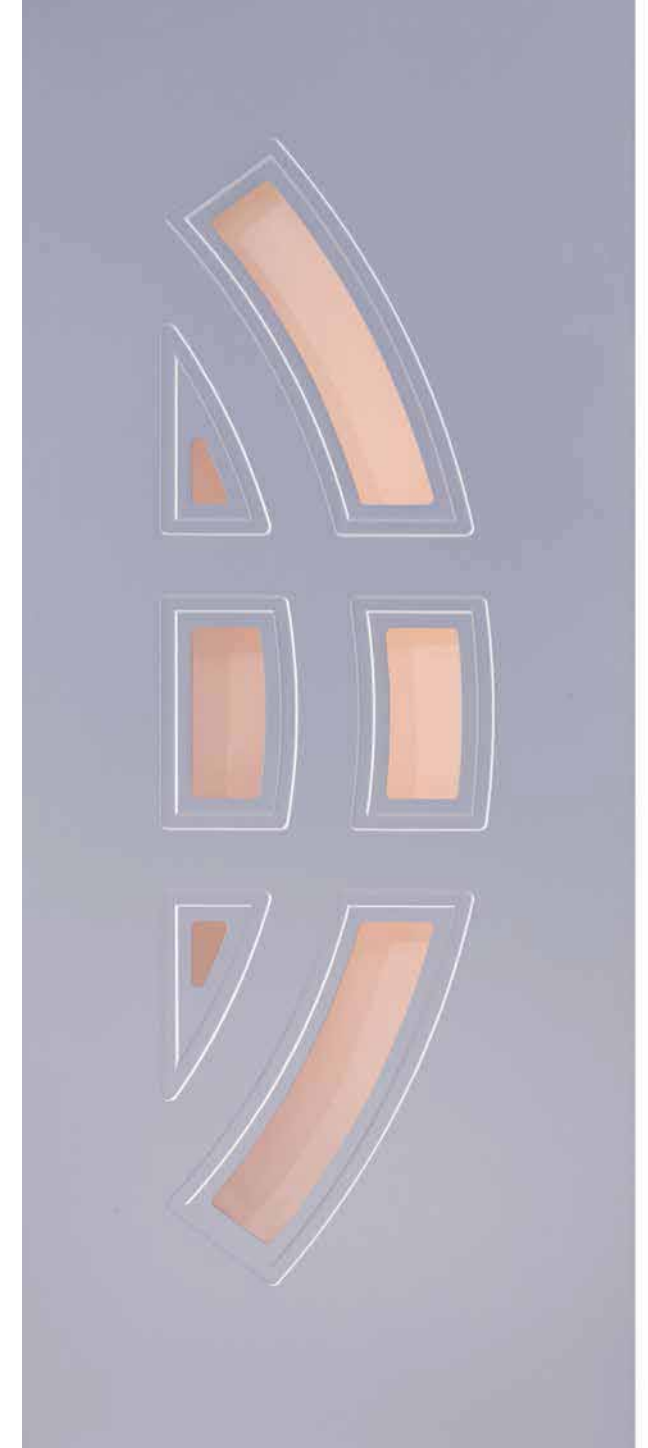

174

Modello realizzato con HDF idrorepellenti e rifiniti con pellicole con superfici intelligenti. Disponibile nelle tipologie cieche e/o predisposte al vetro, oppure nelle versioni coibentate.

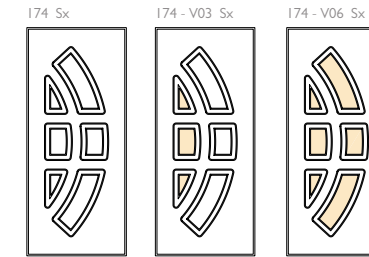

Particolare lato esterno tipo "O"





174

Modello realizzato con HDF idrorepellenti e rifiniti con pellicole con superfici intelligenti. Disponibile nelle tipologie cieche e/o predisposte al vetro, oppure nelle versioni coibentate.

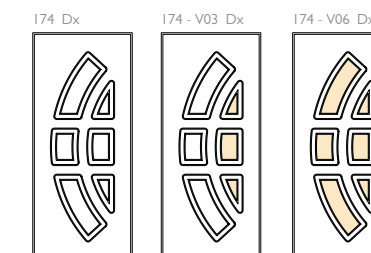

Possibili abbinamenti di colori lato interno





ZER@ CINQUE

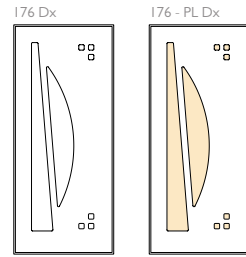

176

Modello realizzato con HDF idrorepellenti e rifiniti con pellicole con superfici intelligenti. Disponibile nelle tipologie cieche e/o predisposte al vetro, oppure nelle versioni coibentate. Le combinazioni cromatiche si possono scegliere nel nostro campionario.

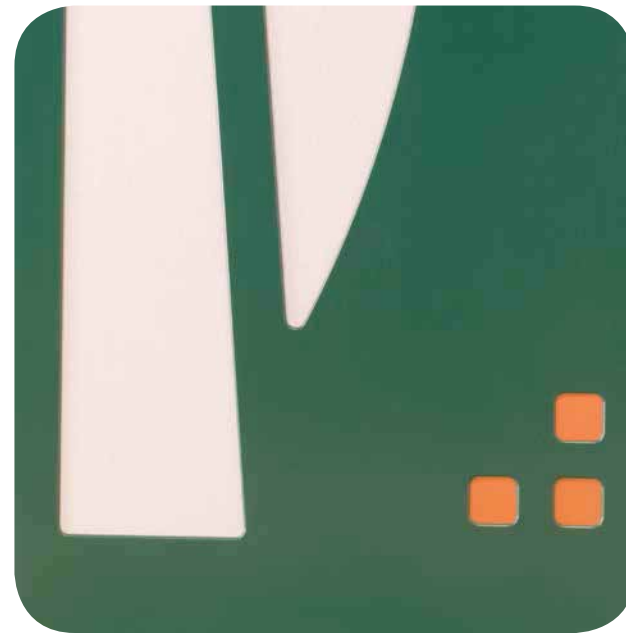

Particolare degli inserti con finitura rame + alluminio





ZER@
CINQUE



181

Modello realizzato con HDF idrorepellenti e rifiniti con pellicole con superfici intelligenti. Disponibile nelle tipologie cieche e/o predisposte al vetro, oppure nelle versioni coibentate.

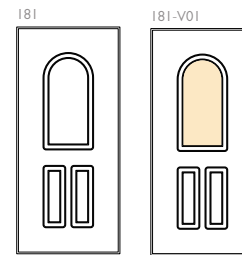

Particolare della lavorazione



182

Modello realizzato con HDF idrorepellenti e rifiniti con pellicole con superfici intelligenti. Disponibile nelle tipologie cieche, oppure nelle versioni coibentate.

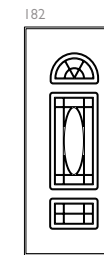

Particolare della lavorazione



ZER@
CINQUE



Particolare della bugna standard in bassorilievo

183

Modello realizzato con HDF idrorepellenti e rifiniti con pellicole con superfici intelligenti. Disponibile nelle tipologie cieche, oppure nelle versioni coibentate.





ZER@
CINQUE



ZER@
CINQUE

184

Modello realizzato con HDF idrorepellenti e rifiniti con pellicole con superfici intelligenti. Disponibile nelle tipologie cieche e/o predisposte al vetro, oppure nelle versioni coibentate.

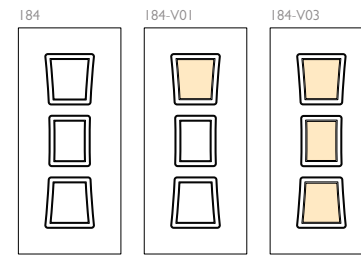

Vista interna Tipo OF



Vista esterna Tipo ON



Particolare vista esterna Tipo ON



Vista esterna Tipo O-OF



Particolare cornice a filo tipo OF





ZER@
CINQUE



ZER@
CINQUE



185

Modello realizzato con HDF idrorepellenti e rifiniti con pellicole con superfici intelligenti. Disponibile nelle tipologie cieche, oppure nelle versioni coibentate.

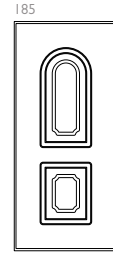

Particolare

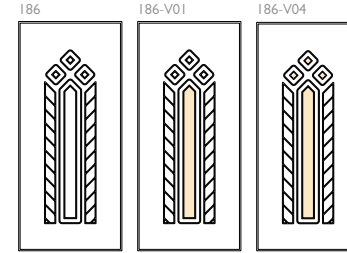

186

Modello realizzato con HDF idrorepellenti e rifiniti con pellicole con superfici intelligenti. Disponibile nelle tipologie cieche e/o predisposte al vetro, oppure nelle versioni coibentate.



Particolare lato esterno





ZER@
CINQUE

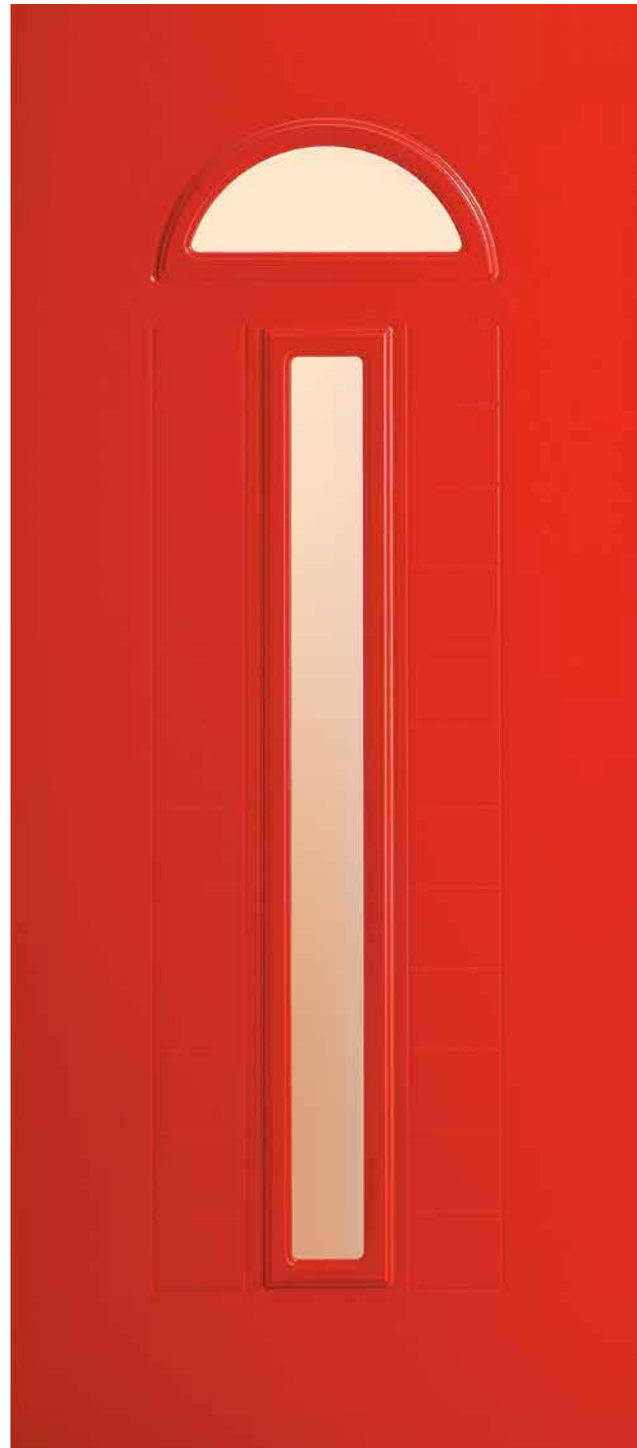

187

Modello realizzato con HDF idrorepellenti e rifiniti con pellicole con superfici intelligenti. Disponibile nelle tipologie cieche e/o predisposte al vetro, oppure nelle versioni coibentate.

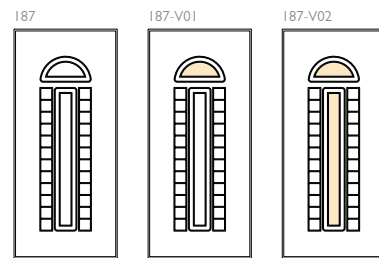

Particolare cornice esterna Tipo ON



ZER@
CINQUE



188

Modello realizzato con HDF idrorepellenti e rifiniti con pellicole con superfici intelligenti. Disponibile nelle tipologie cieche e/o predisposte al vetro, oppure nelle versioni coibentate.

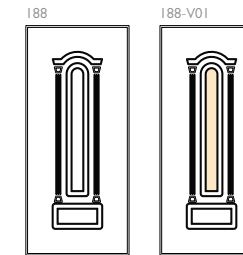



ZER@
CINQUE



Particolare di lavorazione con bugna ridotta (new model)

189

Modello realizzato con HDF idrorepellenti e rifiniti con pellicole con superfici intelligenti. Disponibile nelle tipologie cieche e/o predisposte al vetro, oppure nelle versioni coibentate.

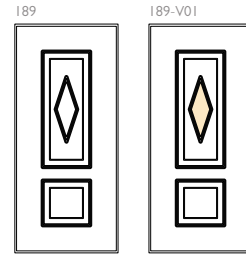

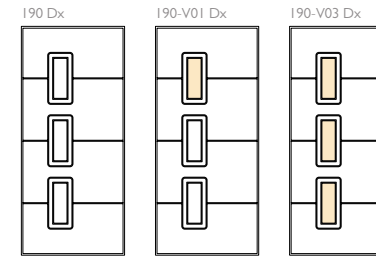

190

Modello realizzato con HDF idrorepellenti e rifiniti con pellicole con superfici intelligenti. Disponibile nelle tipologie cieche e/o predisposte al vetro, oppure nelle versioni coibentate.



191

Modello realizzato con HDF idrorepellenti e rifiniti con pellicole con superfici intelligenti. Disponibile nelle tipologie cieche e/o predisposte al vetro, oppure nelle versioni coibentate.

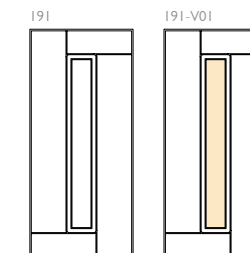



ZER@
CINQUE



ZER@
CINQUE

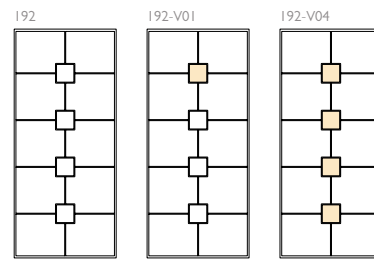
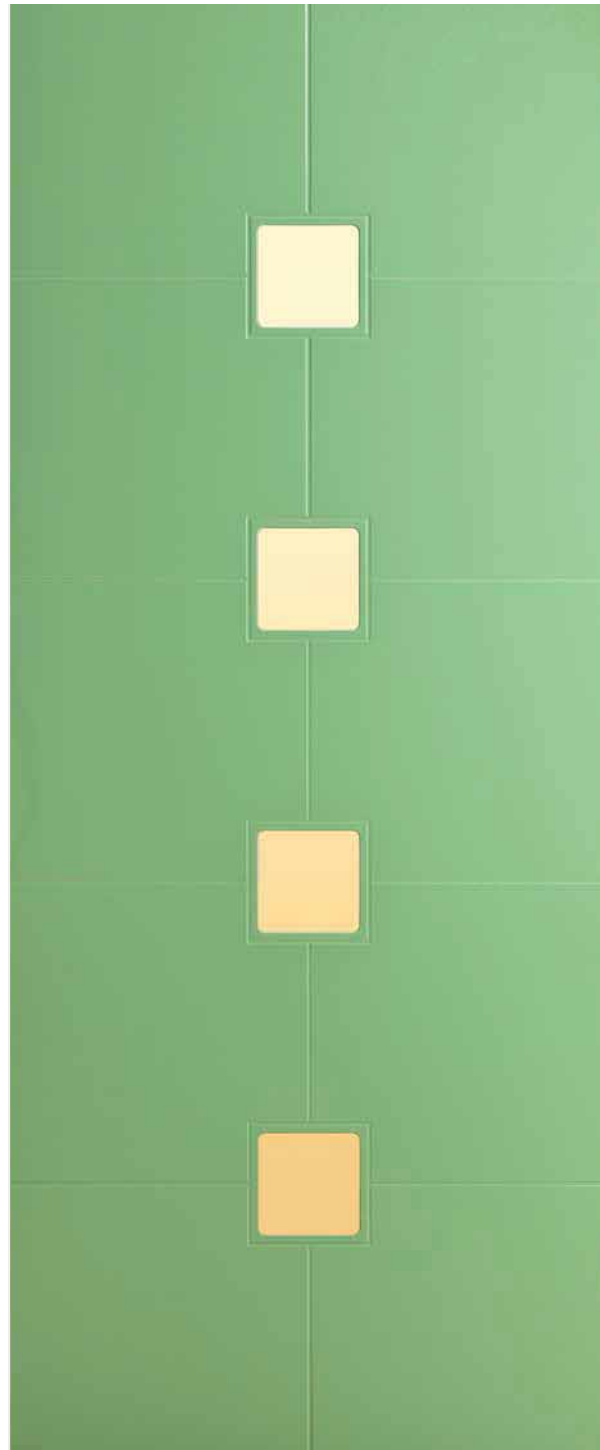

192

Modello realizzato con HDF idrorepellenti e rifiniti con pellicole con superfici intelligenti. Disponibile nelle tipologie cieche e/o predisposte al vetro, oppure nelle versioni coibentate.

Particolare di lavorazione



Particolare di lavorazione

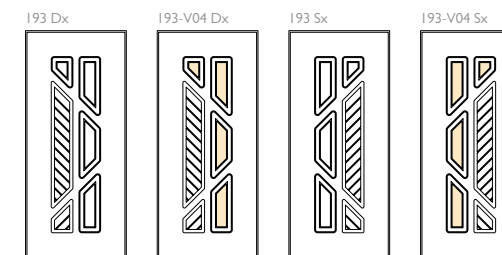

193

Modello realizzato con HDF idrorepellenti e rifiniti con pellicole con superfici intelligenti. Disponibile nelle tipologie cieche e/o predisposte al vetro, oppure nelle versioni coibentate.





ZER@
CINQUE

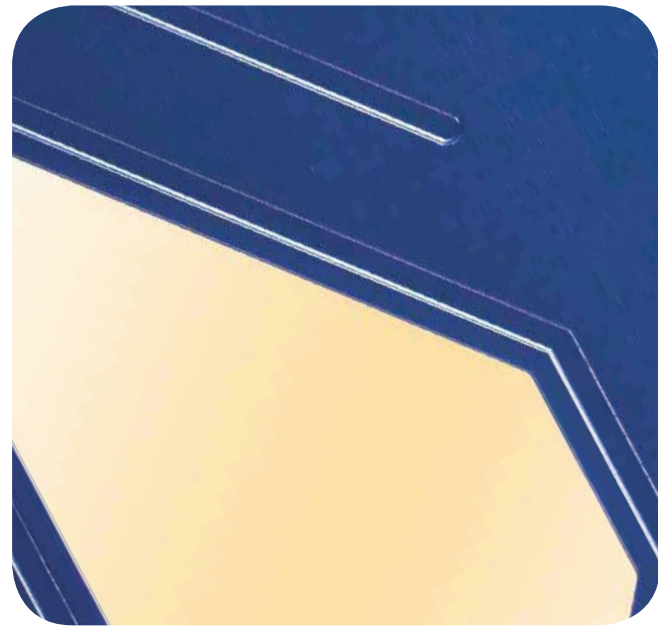

194

Modello realizzato con HDF idrorepellenti e rifiniti con pellicole con superfici intelligenti. Disponibile nelle tipologie cieche e/o predisposte al vetro, oppure nelle versioni coibentate.

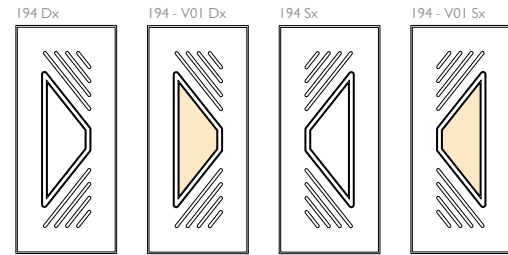



Particolare lato esterno Tipo "O - OF"

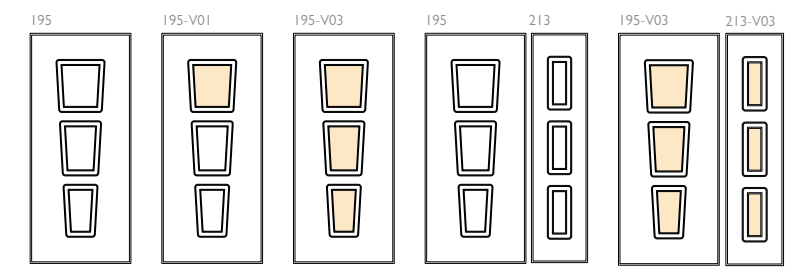

195

Modello realizzato con HDF idrorepellenti e rifiniti con pellicole con superfici intelligenti. Disponibile nelle tipologie cieche e/o predisposte al vetro, oppure nelle versioni coibentate.





ZER@
CINQUE



196

Modello realizzato con HDF idrorepellenti e rifiniti con pellicole con superfici intelligenti. Disponibile nelle tipologie cieche e/o predisposte al vetro, con e senza inserti colorati. Disponibile anche nelle versioni coibentate.

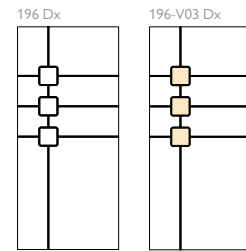

Particolare dell'inserto in finitura alluminio



197

Modello realizzato con HDF idrorepellenti e rifiniti con pellicole con superfici intelligenti. Disponibile nelle tipologie cieche e/o predisposte al vetro, con e senza inserti colorati. Disponibile anche nelle versioni coibentate.

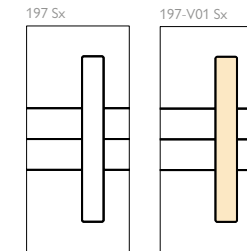

Particolare dell'inserto in finitura rame

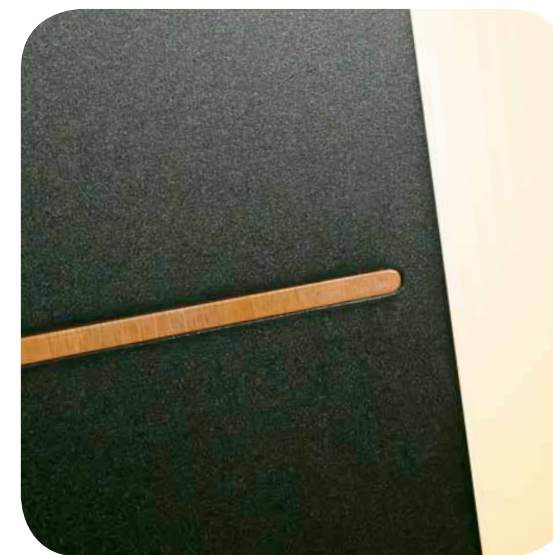

ZER@
CINQUE



ZER
CINQUE

198

Modello realizzato con HDF idrorepellenti e rifiniti con pellicole con superfici intelligenti. Disponibile nelle tipologie cieche e/o predisposte al vetro, con e senza inserti colorati. Disponibile anche nelle versioni coibentate.

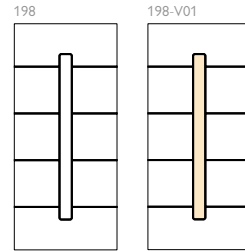

Particolare degli inserti con finitura alluminio





ZER@
CINQUE



199

Modello realizzato con HDF idrorepellenti e rifiniti con pellicole con superfici intelligenti. Disponibile nelle tipologie cieche e/o predisposte al vetro, con e senza inserti colorati. Disponibile anche nelle versioni coibentate.

199-V02 Dx

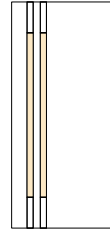

Particolare inserti con finitura rovere sbiancato



200

Modello realizzato con HDF idrorepellenti e rifiniti con pellicole con superfici intelligenti. Disponibile nelle tipologie cieche, con e senza inserti colorati. Disponibile anche nelle versioni coibentate.

200 Dx

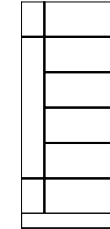

200 Sx

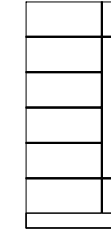

Particolari inserti con finitura antracite



ZER@
CINQUE





ZER@
CINQUE



300

Modello realizzato con HDF idrorepellenti e rifiniti con pellicole con superfici intelligenti. Disponibile nelle tipologie cieche, con e senza inserti colorati. Disponibile anche nelle versioni coibentate.

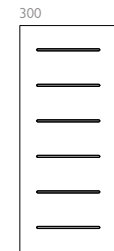

Particolare colore Corten con inserti in noce scuro



ZER@
CINQUE



301

Modello realizzato con HDF idrorepellenti e rifiniti con pellicole con superfici intelligenti. Disponibile nelle tipologie cieche e/o predisposte al vetro, con e senza inserti colorati. Disponibile anche nelle versioni coibentate.

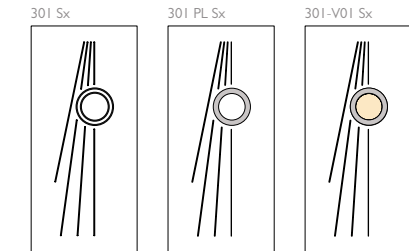

Particolare del pannello Rovere Wenge con inserti color alluminio

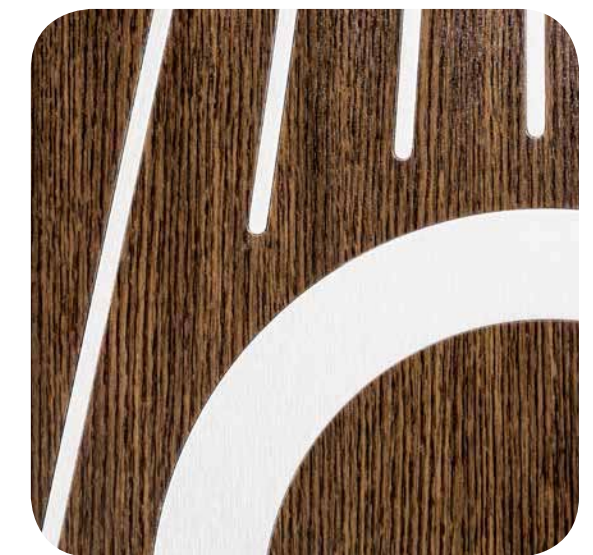



ZER
CINQUE



302

Modello realizzato con HDF idrorepellenti e rifiniti con pellicole con superfici intelligenti. Disponibile nelle tipologie cieche, con e senza inserti colorati. Disponibile anche nelle versioni coibentate.

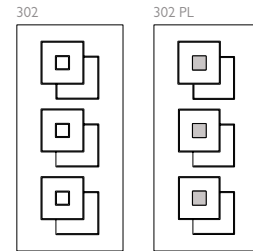

Particolare Metallic Wood con inserti color Asphalt





ZER
CINQUE



ZER
CINQUE

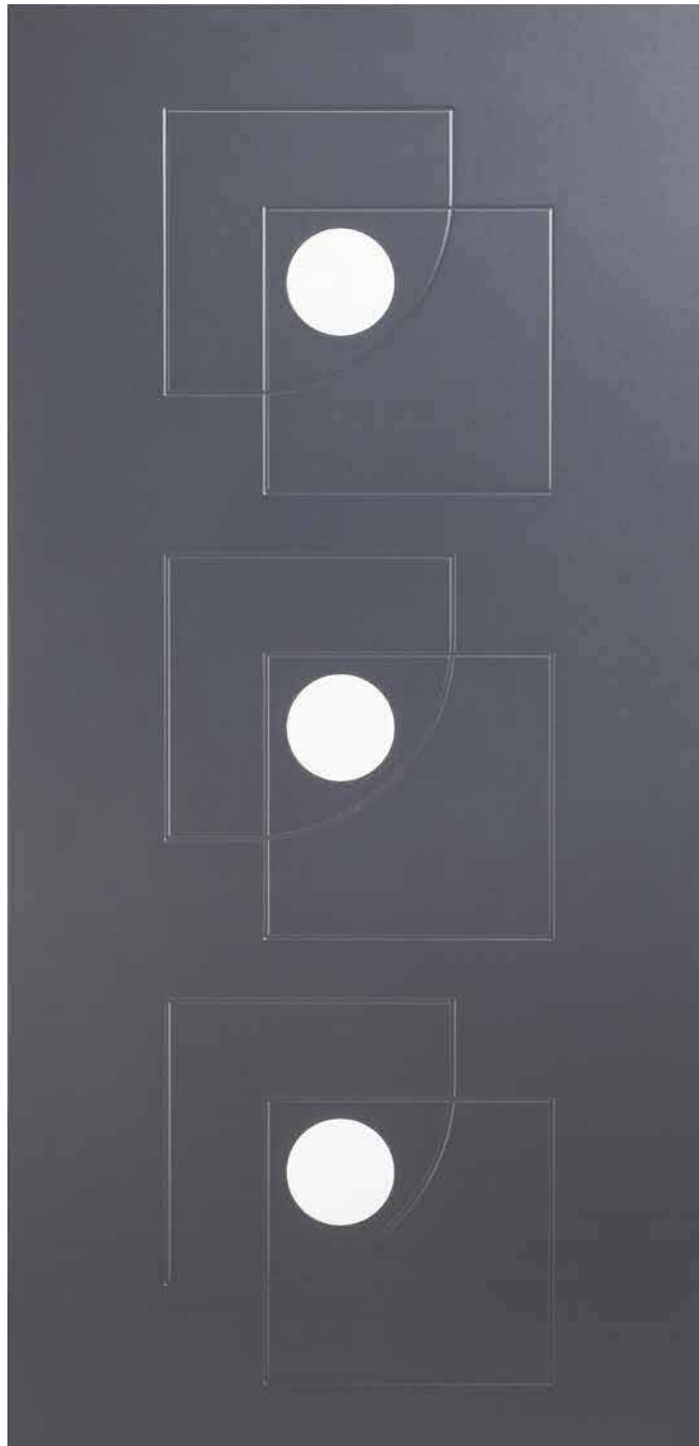

Particolare degli inserti con finitura bianco liscio

303

Modello realizzato con HDF idrorepellenti e rifiniti con pellicole con superfici intelligenti. Disponibile nelle tipologie cieche, con e senza inserti colorati. Disponibile anche nelle versioni coibentate.

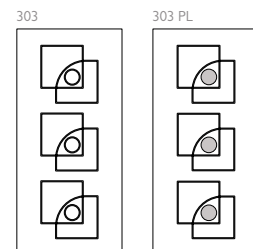

304

Modello realizzato con HDF idrorepellenti e rifiniti con pellicole con superfici intelligenti. Disponibile nelle tipologie cieche e/o predisposte al vetro, con e senza inserti colorati. Disponibile anche nelle versioni coibentate.

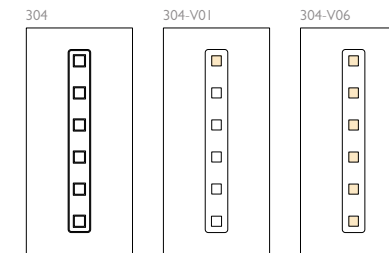

Particolare della cornice fermavetro in colorazione legno. Non forniamo i vetri.





305

Modello realizzato con HDF idrorepellenti e rifiniti con pellicole con superfici intelligenti. Disponibile nelle tipologie cieche e/o predisposte al vetro, con e senza inserti colorati. Disponibile anche nelle versioni coibentate.

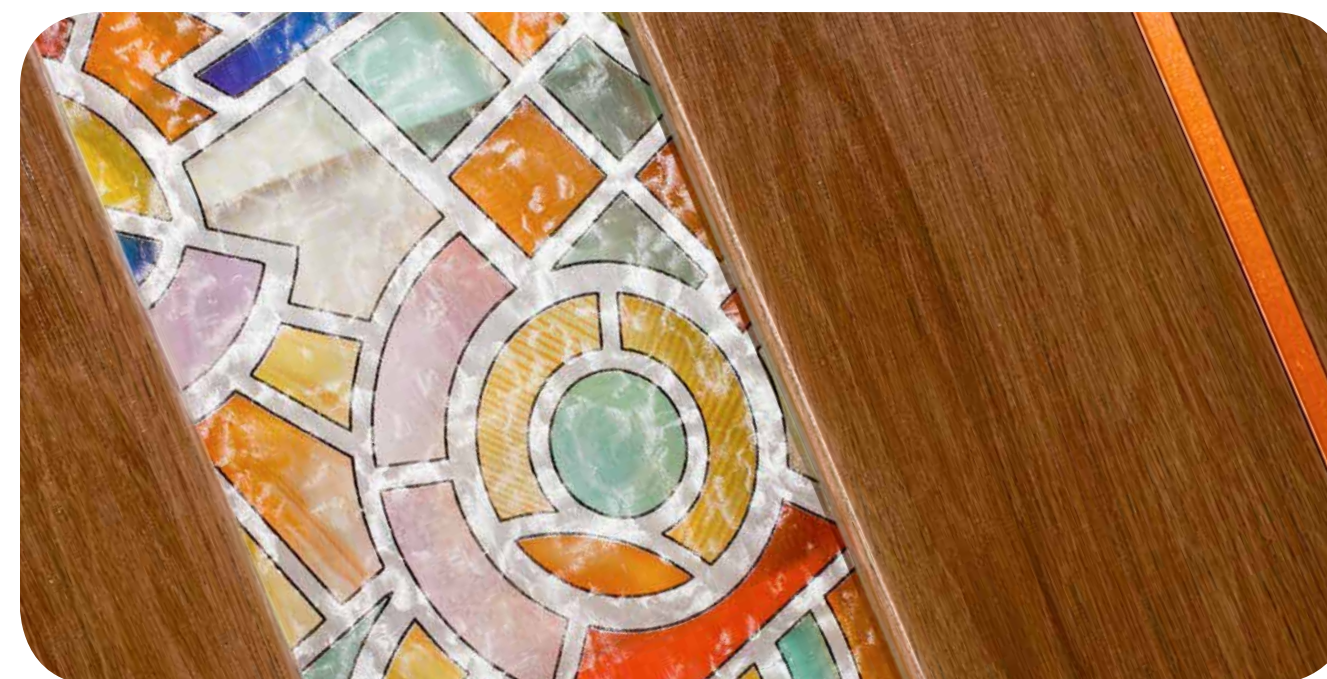
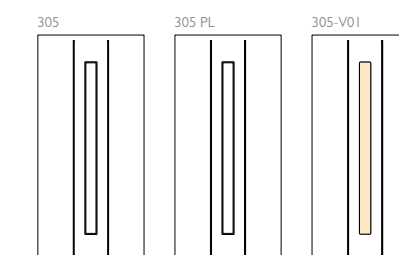

Particolare degli inserti con finitura Rame. Non forniamo i vetri.



ZER@
CINQUE



306

Modello realizzato con HDF idrorepellenti e rifiniti con pellicole con superfici intelligenti. Disponibile nelle tipologie cieche e/o predisposte al vetro, con e senza inserti colorati. Disponibile anche nelle versioni coibentate.

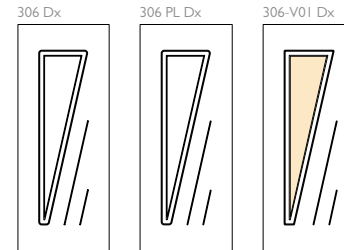

Particolare degli inserti con finitura Golden Oak.





307

Modello realizzato con HDF idrorepellenti e rifiniti con pellicole con superfici intelligenti. Disponibile nelle tipologie cieche e/o predisposte al vetro, con e senza inserti colorati. Disponibile anche nelle versioni coibentate.

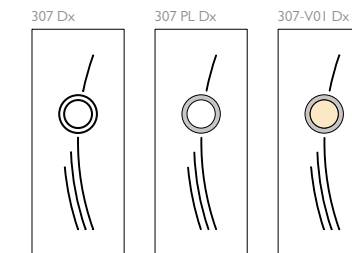

Particolare del pannello in rovere sbiancato con inserti in Corten.





ZER@
CINQUE



308

Modello realizzato con HDF idrorepellenti e rifiniti con pellicole con superfici intelligenti. Disponibile nelle tipologie cieche, con e senza inserti colorati. Disponibile anche nelle versioni coibentate.

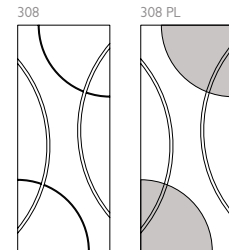

Particolare di un abbinamento cromatico.
Scelta dalla Ns. cartella colori



309

Modello realizzato con HDF idrorepellenti e rifiniti con pellicole con superfici intelligenti. Disponibile nelle tipologie cieche, con e senza inserti colorati. Disponibile anche nelle versioni coibentate.

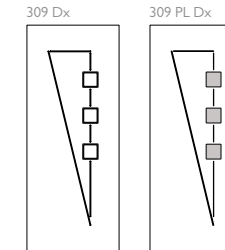

Particolare degli inserti con finitura rossa e verde



ZER@
CINQUE

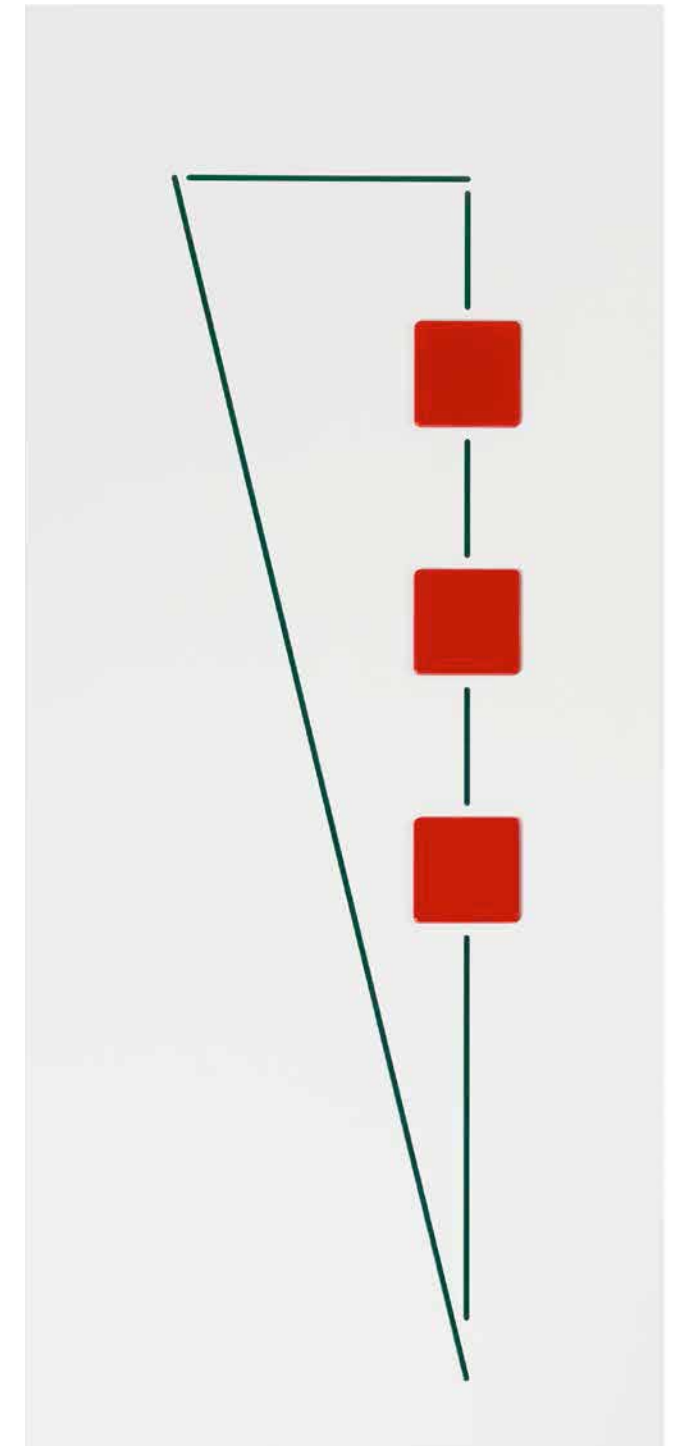



Particolare delle cornici esterne in colore legno



310

Modello realizzato con HDF idrorepellenti e rifiniti con pellicole con superfici intelligenti. Disponibile nelle tipologie cieche e/o predisposte al vetro, con e senza inserti colorati. Disponibile anche nelle versioni coibentate.

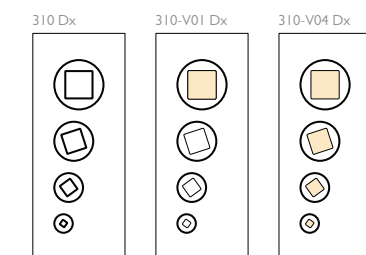



ZER@
CINQUE

Particolare doga da 10 mm



311

Modello realizzato con HDF idrorepellenti e rifiniti con pellicole con superfici intelligenti. Disponibile nelle tipologie cieche normali, oppure nelle versioni coibentate.

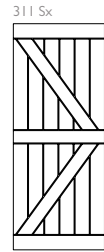



ZER@
CINQUE

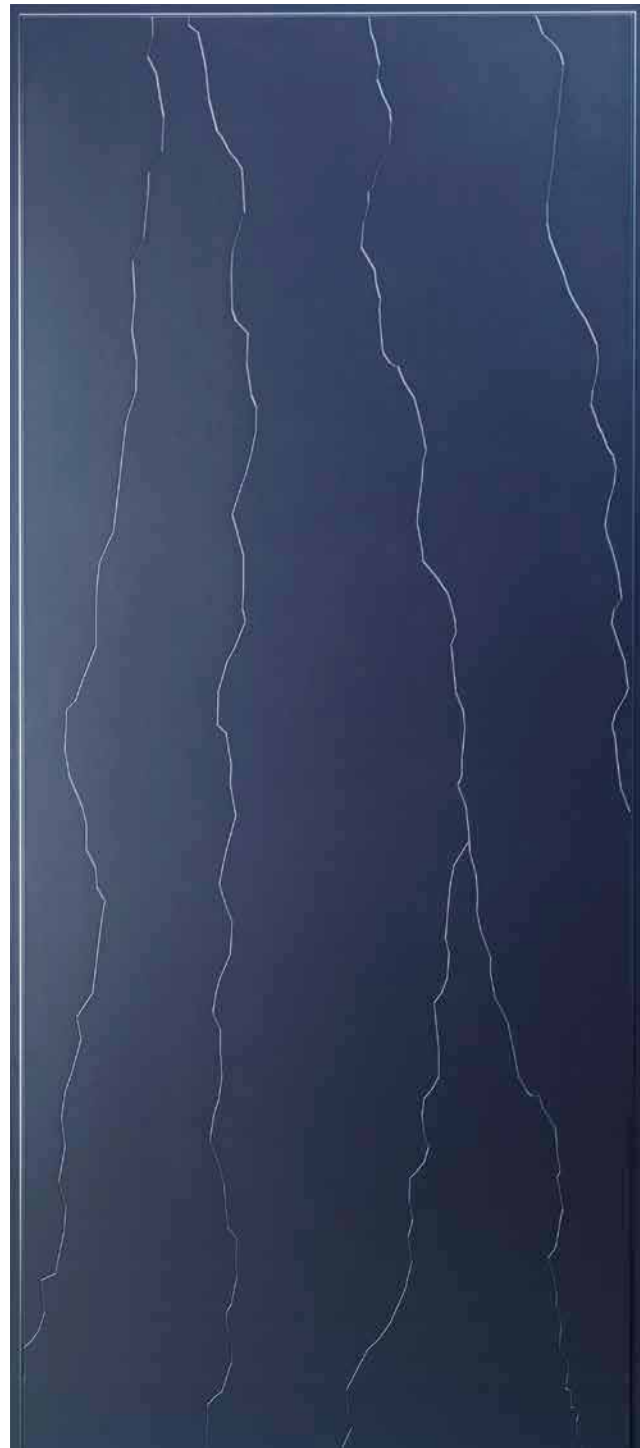

312

Modello realizzato con HDF idrorepellenti e rifiniti con pellicole con superfici intelligenti. Disponibile nelle tipologie cieche normali, oppure nelle versioni coibentate.

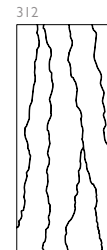

Particolare doga da 3 mm



313

Modello realizzato con HDF idrorepellenti e rifiniti con pellicole con superfici intelligenti. Disponibile nelle tipologie cieche normali, oppure nelle versioni coibentate. Effetto 3D

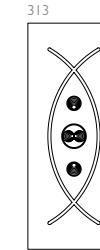

Particolare effetto 3D in bassorilievo



ZER@
CINQUE



ZER@
CINQUE



314

Modello realizzato con HDF idrorepellenti e rifiniti con pellicole con superfici intelligenti. Disponibile nelle tipologie cieche normali, oppure nelle versioni coibentate. Effetto 3D

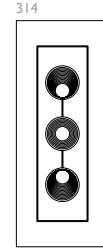

Particolare effetto 3D in alto rilievo. Tipo PN



ZER@
CINQUE



315

Modello realizzato con HDF idrorepellenti e rifiniti con pellicole con superfici intelligenti. Disponibile nelle tipologie cieche normali, oppure nelle versioni coibentate. Effetto 3D

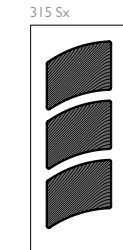

Particolare effetto 3D in altorilievo Tipo PN



ZER@
CINQUE



ZER@
CINQUE

316

Modello realizzato con HDF idrorepellenti e rifiniti con pellicole con superfici intelligenti. Disponibile nelle tipologie cieche e/o predisposte al vetro normali, oppure nelle versioni coibentate.

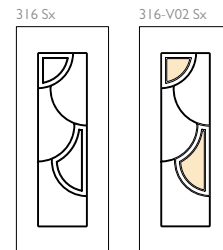

Particolare cornice esterna Tipo ON



317

Modello realizzato con HDF idrorepellenti e rifiniti con pellicole con superfici intelligenti. Disponibile nelle tipologie cieche e/o predisposte al vetro, con e senza inserti colorati. Disponibile anche nelle versioni coibentate.

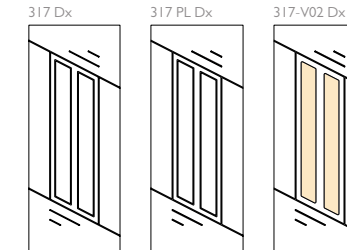

Particolare degli inserti con finitura legno





ZER@
CINQUE



318

Modello realizzato con HDF idrorepellenti e rifiniti con pellicole con superfici intelligenti. Disponibile nelle tipologie cieche, con e senza inserti colorati. Disponibile anche nelle versioni coibentate.

318 Sx



318 PL Sx

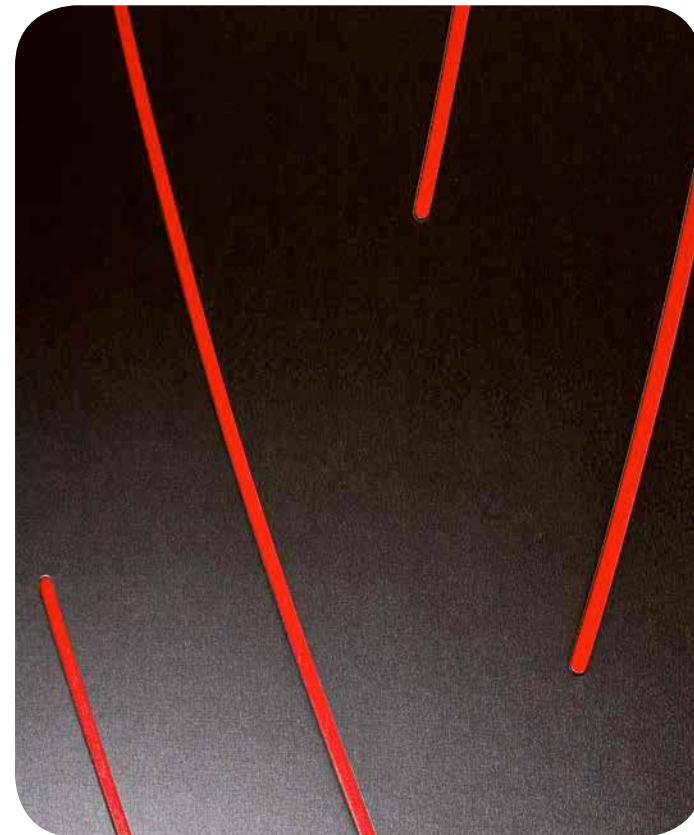
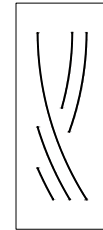

Particolare degli inserti con finitura rossa

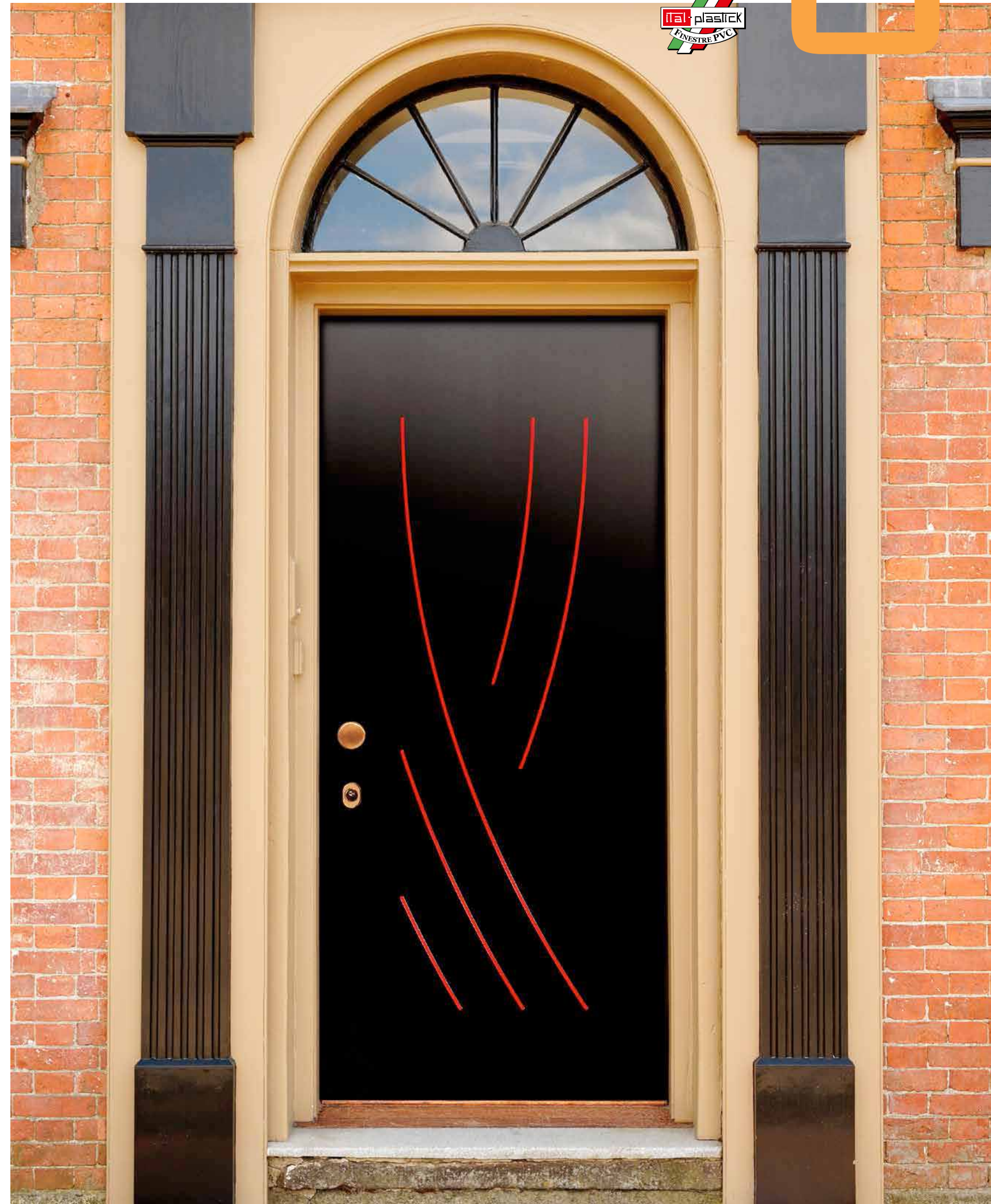



ZER@
CINQUE



319

Modello realizzato con HDF idrorepellenti e rifiniti con pellicole con superfici intelligenti. Disponibile nelle tipologie cieche e/o predisposte al vetro normali, oppure nelle versioni coibentate.

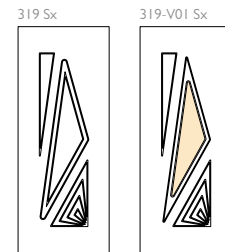

Particolare doga da 10 mm



320

Modello realizzato con HDF idrorepellenti e rifiniti con pellicole con superfici intelligenti. Disponibile nelle tipologie cieche normali, oppure nelle versioni coibentate. Effetto 3D

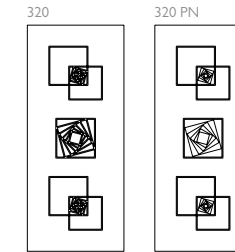

Particolare effetto 3D



ZER@
CINQUE





ZER@
CINQUE



ZER@
CINQUE



321

Modello realizzato con HDF idrorepellenti e rifiniti con pellicole con superfici intelligenti. Disponibile nelle tipologie cieche, con e senza inserti colorati. Disponibile anche nelle versioni coibentate.

321 Sx

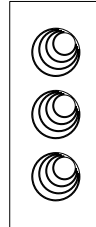

321 PL Sx

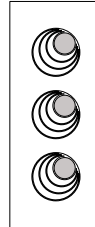

Particolare doga da 10 mm



322

Modello realizzato con HDF idrorepellenti e rifiniti con pellicole con superfici intelligenti. Disponibile nelle tipologie cieche e/o predisposte al vetro, con e senza inserti colorati. Disponibile anche nelle versioni coibentate.

322 Sx



322 PL Sx

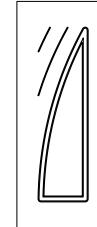

322-V01 Sx

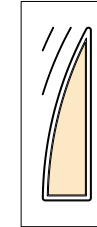

Particolare bugna standard e inserti con finitura alluminio





ZER
CINQUE



ZER
CINQUE



323

Modello realizzato con HDF idrorepellenti e rifiniti con pellicole con superfici intelligenti. Disponibile nelle tipologie cieche e/o predisposte al vetro normali, oppure nelle versioni coibentate.

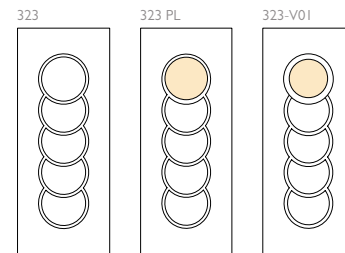

Particolare bugna ribassata da 30 mm



324

Modello realizzato con HDF idrorepellenti e rifiniti con pellicole con superfici intelligenti. Disponibile nelle tipologie cieche, con e senza inserti colorati. Disponibile anche nelle versioni coibentate.

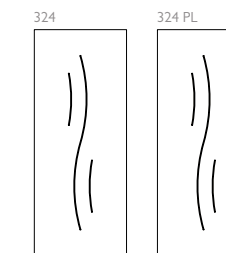

Particolari degli inserti con finitura Asphalt





Particolare effetto 3D



Particolare effetto 3D

325

Modello realizzato con HDF idrorepellenti e rifiniti con pellicole con superfici intelligenti. Disponibile nelle tipologie cieche e/o predisposte al vetro normali, oppure nelle versioni coibentate. Effetto 3D

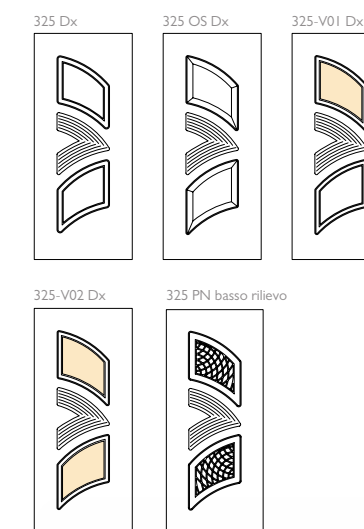



ZER@
CINQUE



326

Modello realizzato con HDF idrorepellenti e rifiniti con pellicole con superfici intelligenti. Disponibile nelle tipologie cieche, con e senza inserti colorati. Disponibile anche nelle versioni coibentate.

326 Dx

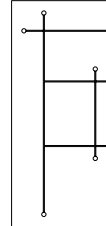

326 PL Dx

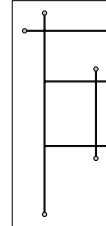

Particolari degli inserti con finitura alluminio



ZER@
CINQUE

327

Modello realizzato con HDF idrorepellenti e rifiniti con pellicole con superfici intelligenti. Disponibile nelle tipologie cieche, con e senza inserti colorati. Disponibile anche nelle versioni coibentate.

327 Dx



327 PL Dx

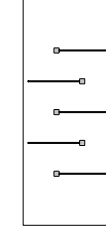

Particolare degli inserti in finitura rame

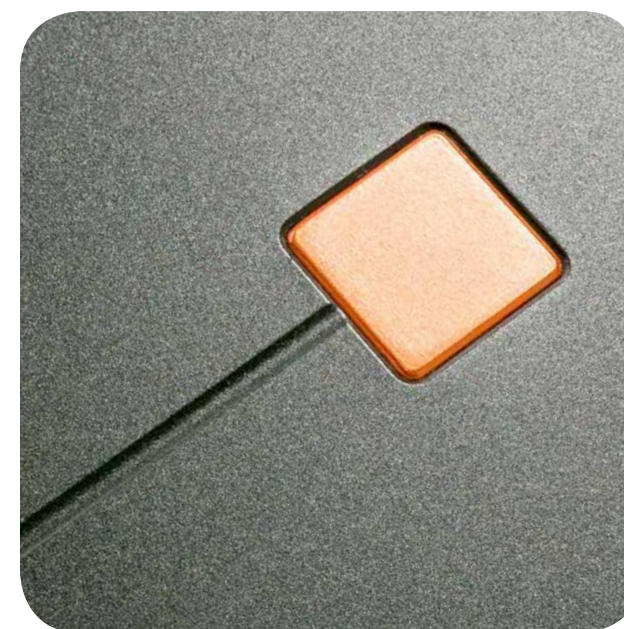



ZER@
CINQUE

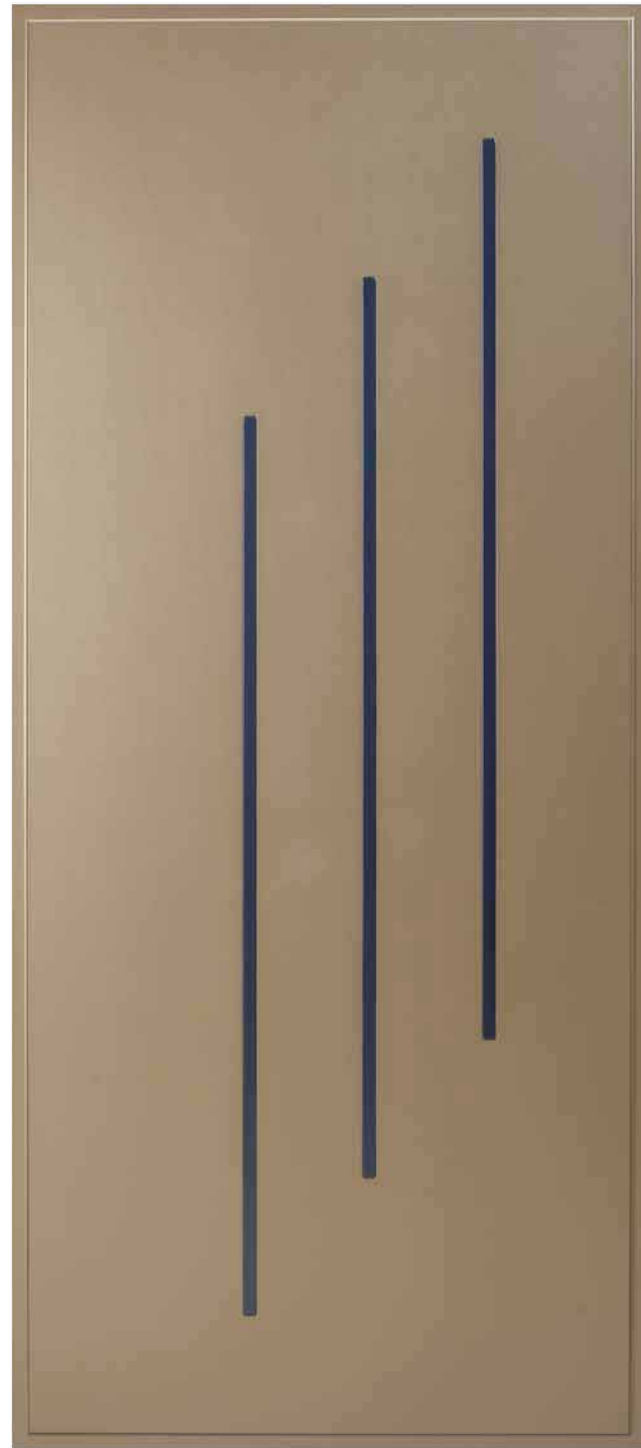

328

Modello realizzato con HDF idrorepellenti e rifiniti con pellicole con superfici intelligenti. Disponibile nelle tipologie cieche, con e senza inserti colorati. Disponibile anche nelle versioni coibentate.

328 Sx

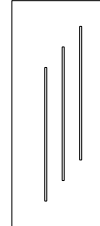

328 PL Sx

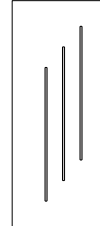

Particolare degli inserti con finitura azzurra

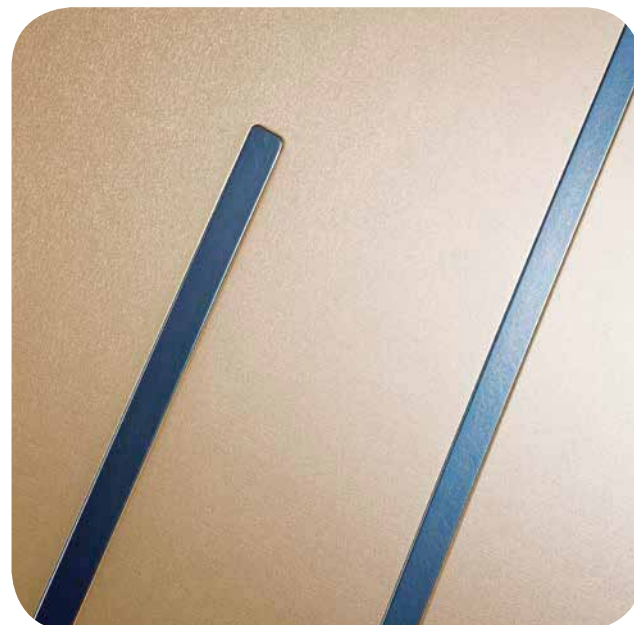

ZER@
CINQUE



329

Modello realizzato con HDF idrorepellenti e rifiniti con pellicole con superfici intelligenti. Disponibile nelle tipologie cieche, con e senza inserti colorati. Disponibile anche nelle versioni coibentate.

329 PL

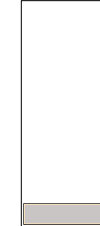



ZER@
CINQUE



Particolare fascia centrale con finitura alluminio.

330

Modello realizzato con HDF idrorepellenti e rifiniti con pellicole con superfici intelligenti. Disponibile nelle tipologie cieche, con e senza inserti colorati. Disponibile anche nelle versioni coibentate.

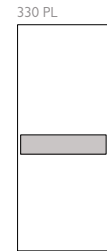



ZER@
CINQUE

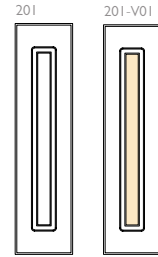

201

Modello realizzato con HDF idrorepellenti e rifiniti con pellicole con superfici intelligenti. Disponibile nelle tipologie cieche e/o predisposte al vetro, oppure nelle versioni coibentate.

Particolare bugne



Particolare cornice



ZER@
CINQUE



206

Modello realizzato con HDF idrorepellenti e rifiniti con pellicole con superfici intelligenti. Disponibile nelle tipologie cieche e/o predisposte al vetro, oppure nelle versioni coibentate.

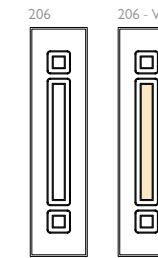

Particolare della bugna standard



ZER@
CINQUE



ZER@
CINQUE



213

Modello realizzato con HDF idrorepellenti e rifiniti con pellicole con superfici intelligenti. Disponibile nelle tipologie cieche e/o predisposte al vetro, oppure nelle versioni coibentate.

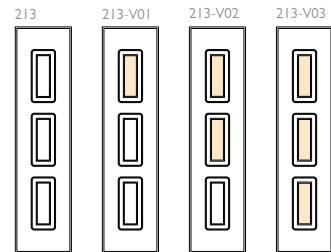

Particolare di lavorazione



214

Modello realizzato con HDF idrorepellenti e rifiniti con pellicole con superfici intelligenti. Disponibile nelle tipologie cieche. Disponibile anche nelle versioni coibentate.



215

Modello realizzato con HDF idrorepellenti e rifiniti con pellicole con superfici intelligenti. Disponibile nelle tipologie cieche, con e senza inserti colorati ed anche nelle versioni coibentate. Da abbinare ai pannelli con inserti colorati

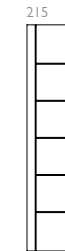

Particolare degli inserti con finitura legno

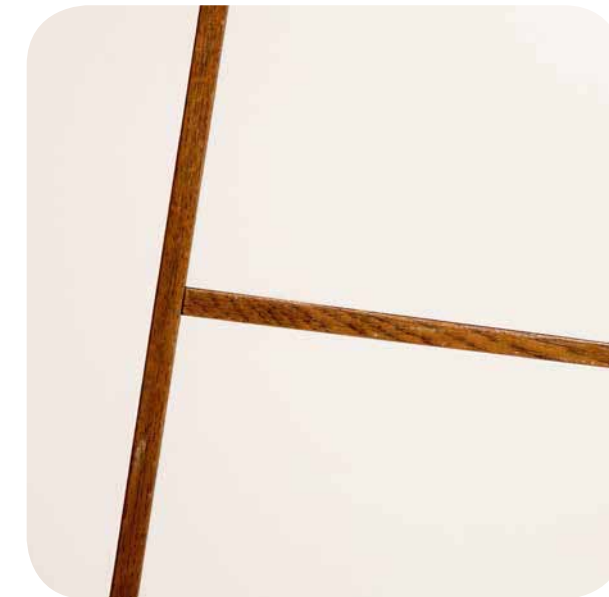



V-24

Porta finestra
con scuretti e
sottotraversi

UR



Particolare di chiusura con tavellino



V-24

UR

Scuretto con battuta
perimetrale e rinforzo
interno da 10x3 mm

V-24



Particolare della bugna in bassorilievo



ZER@
CINQUE



ZER@
CINQUE



RO



RB



Lastre dogate

Sottotraversi dogati in HDF exterior anche nella versione coibentata.



RV

Sottotraversi

Sottotraversi a rilievo in HDF exterior anche nella versione coibentata.



S



S





ZER
CINQUE



ZER
CINQUE



Sottotraversi

Sottotraversi in bassorilievo
realizzati in HDF exterior
anche nella versione
coibentata.



TA



TB



TC



TD



T

Particolare bugna Tipo "TB"



Particolare bugna Tipo "U"



Particolare bugna Tipo "UR"



U



UR



U



UR



ZER
CINQUE

Particolari di lavorazione



Particolare della bugna standard in bassorilievo



Particolare della bugna ribassata da 30 mm



Particolare della doga da 10 mm



Particolare doga da 3 mm



Particolare lato esterno tipo "O"



Particolare cornice a filo tipo OF



Particolare cornice esterna Tipo ON



Particolari inserti con finitura antracite

Particolare di lavorazione con bugna ridotta (new model)



ZER
CINQUE

Scuretti

Scuretti interni speciali con armatura, realizzati in HDF exterior.
Per altezze inferiori a 1 mt: 1 riquadro.
Per altezze superiori a 1 mt: 2 riquadri.



V-16 / V-18 Fuorisquadro



V-16 / V-18 Arco



Particolare V-16 Fuorisquadro



Particolare V-16 Arco





ZER
CINQUE

V-18-15

Scuretti interni, realizzati in HDF exterior.
Con battuta perimetrale a 15 mm.
Per altezze inferiori a 1 mt : 1 riquadro.
Per altezze superiori a 1 mt: 2 riquadri.



Particolare V-18-15



ZER
CINQUE

V-16

Scuretti interni, realizzati in HDF exterior. Con rinforzo interno da 10x3 mm. Per altezze inferiori a 1 mt: 1 riquadro. Per altezze superiori a 1 mt: 2 riquadri.

V-18

Scuretti interni, realizzati in HDF exterior. Senza rinforzo interno. Per altezze inferiori a 1 mt: 1 riquadro. Per altezze superiori a 1 mt: 2 riquadri.

Particolare V-16 / V-18





ZER
CINQUE

V-16 DV / V-18 DV

Scuretto interno dogato verticale, in HDF exterior. Con rinforzo interno da 10x3 mm.
Per altezze inferiori a 1 mt: 1 riquadro. Per altezze superiori a 1 mt: 2 riquadri.



Particolare delle doghe



Particolari di lavorazione



ZER
CINQUE

V-16 FM / V-18 FM

Scuretto interno tipo massello in HDF exterior con rinforzo interno da 10x3 mm.
Per altezze inferiori a 1 mt: 1 riquadro. Per altezze superiori a 1 mt: 2 riquadri





ZER@
CINQUE



ZER@
CINQUE



V-18

Scuretti interni a Libro con cerniera a scomparsa, realizzati in HDF exterior. Per altezze inferiori a 1 mt: 1 riquadro. Per altezze superiori a 1 mt: 2 riquadri. Le cerniere vengono inserite come per gli scuretti normali.



Cerniere a scomparsa per scuretti a libro



Cromo satinato



Ottone Brunito



Oro Lucido



ZEROCINQUE



1C - Cromo

Cerniere per scuretti interni

1C - 9016



1C - 1013



1C - Oro



1C - 8022



ZEROCINQUE

Tavellini per chiusura scuretti interni

1T - CS

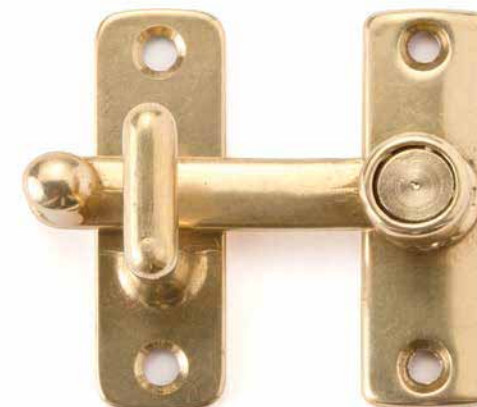
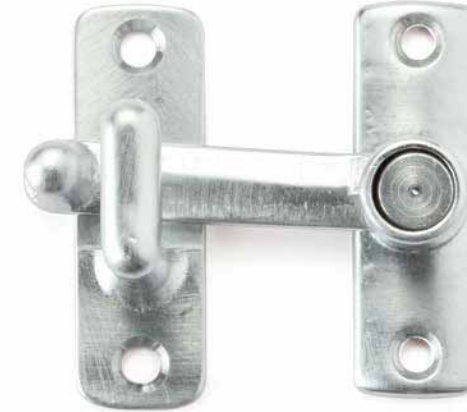

1T - OL

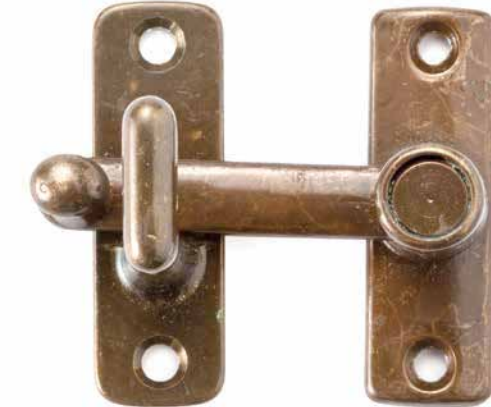

1T - OB



ZER@
CINQUE



ZER@
CINQUE

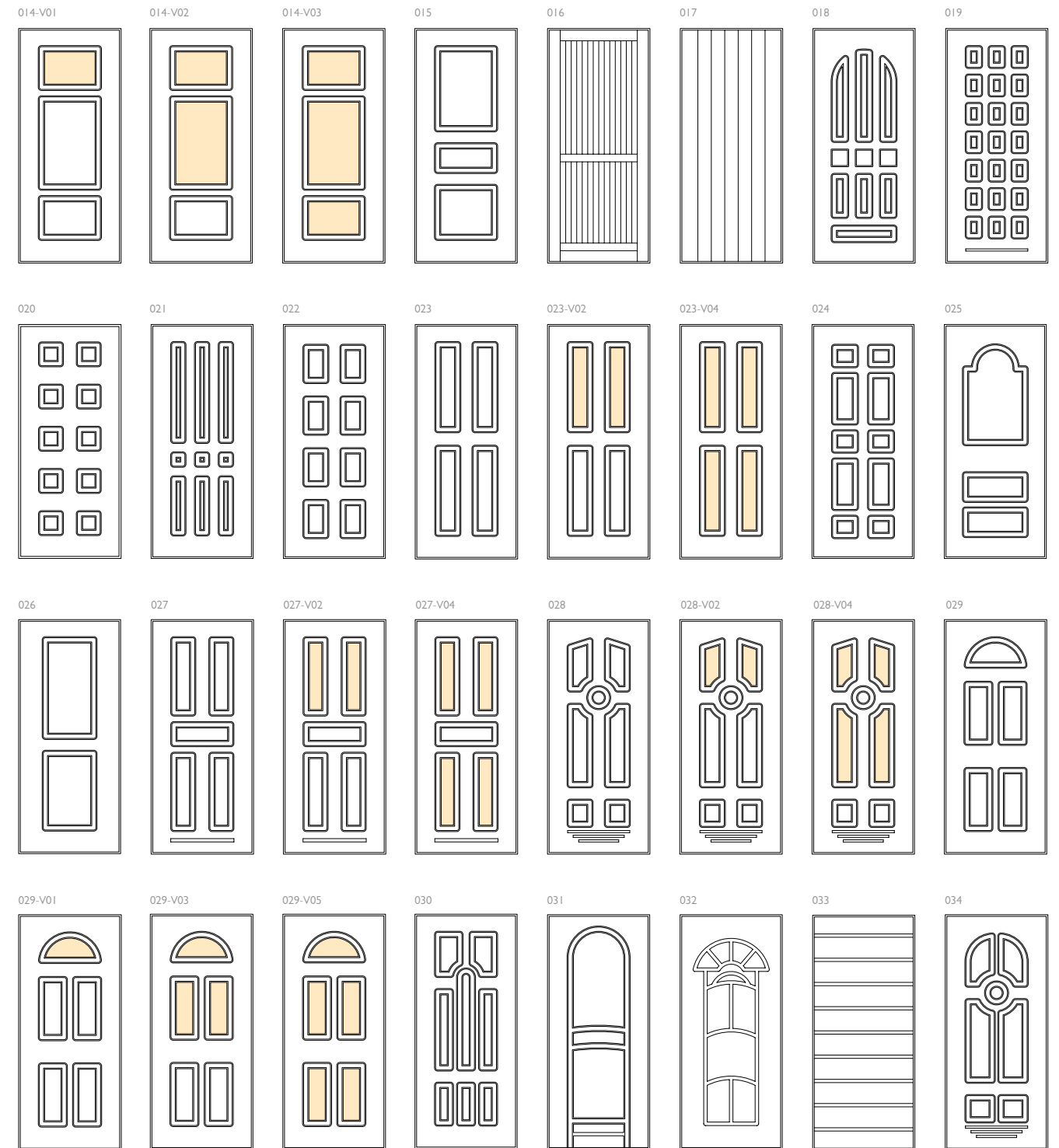
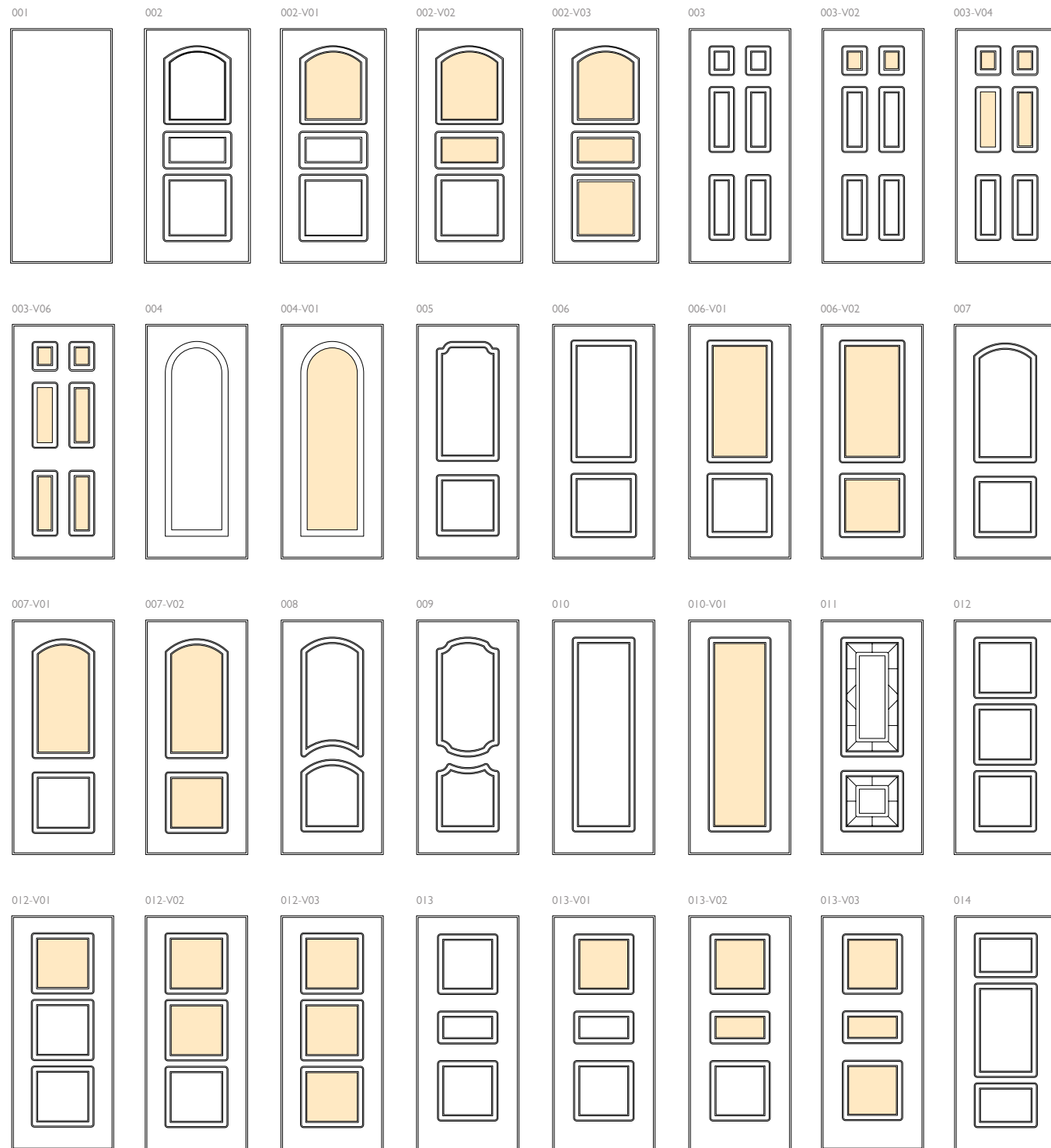



ZER@
CINQUE



ZER@
CINQUE

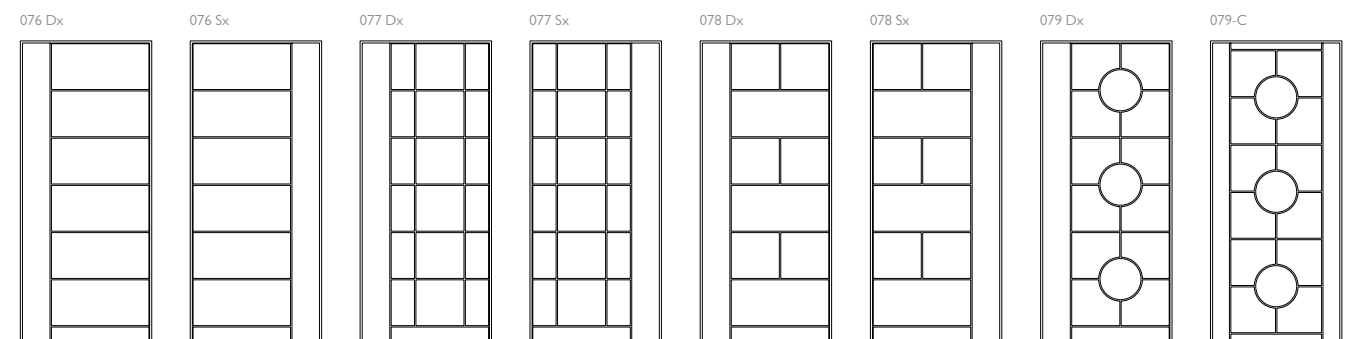
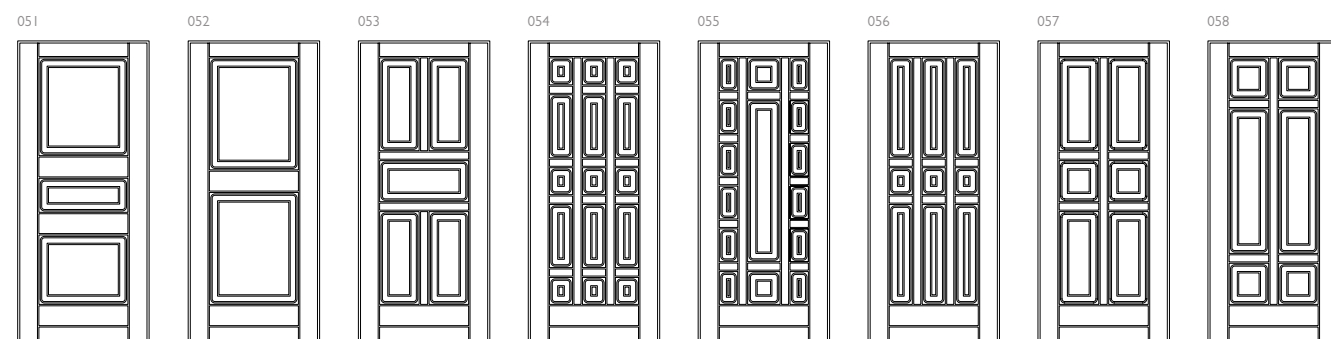
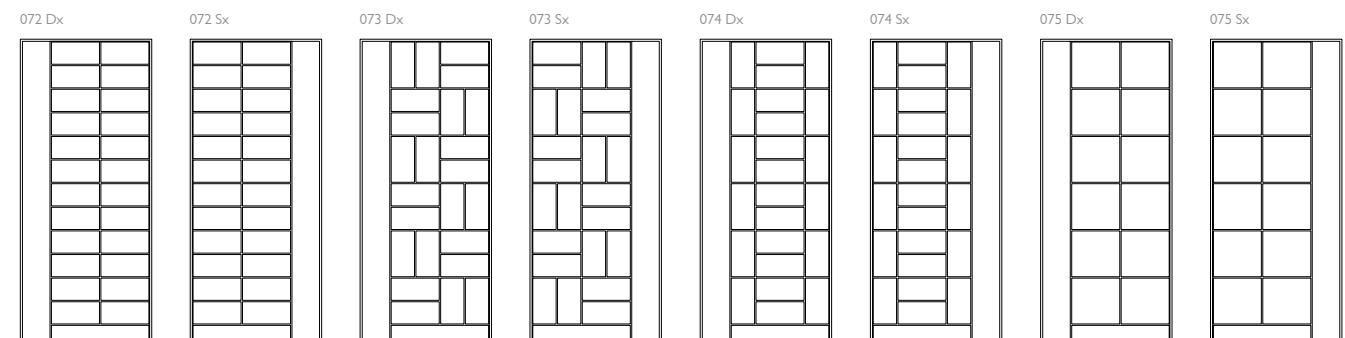
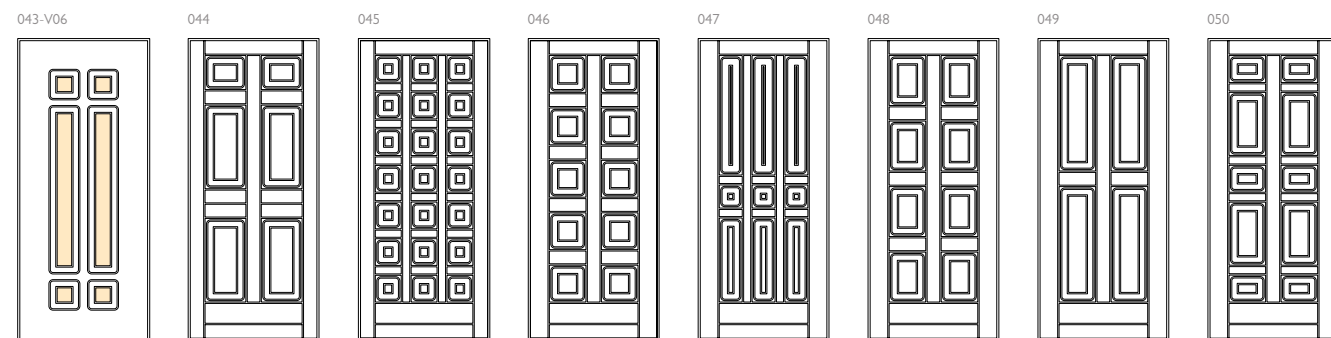
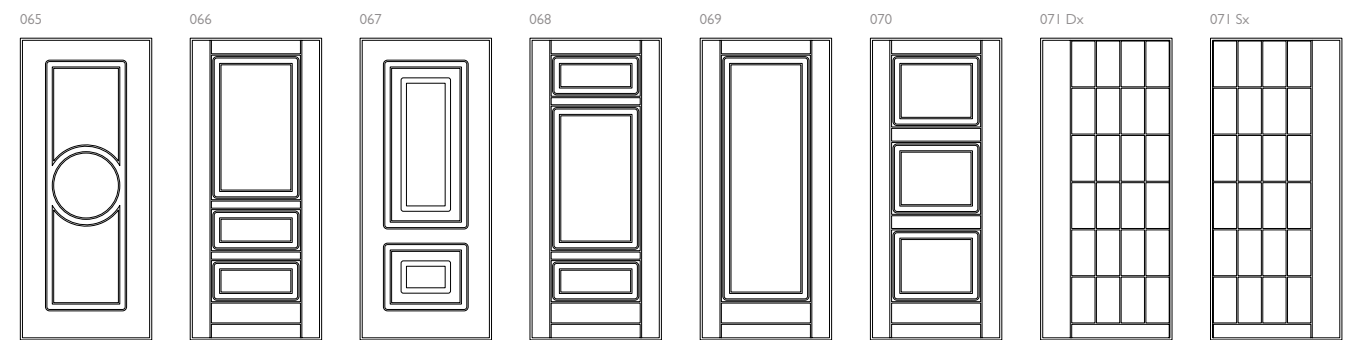
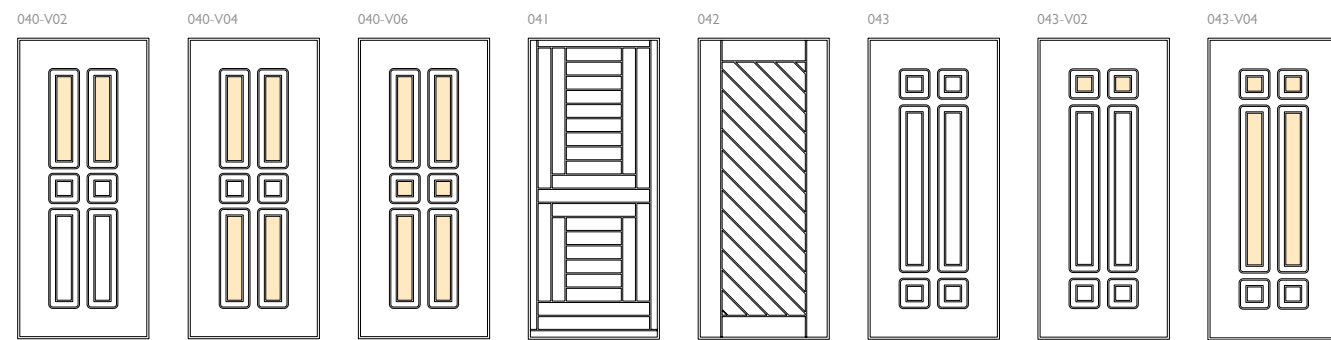
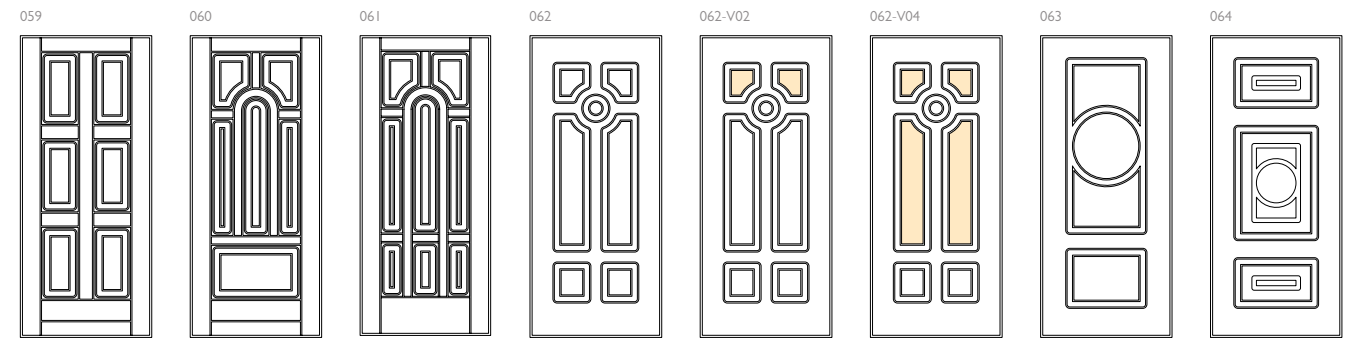
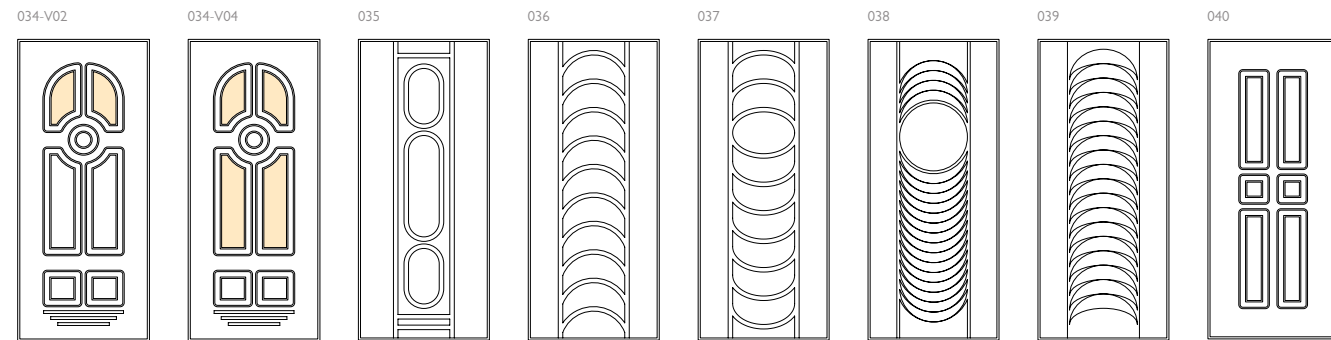



ZER@
CINQUE



ZER@
CINQUE

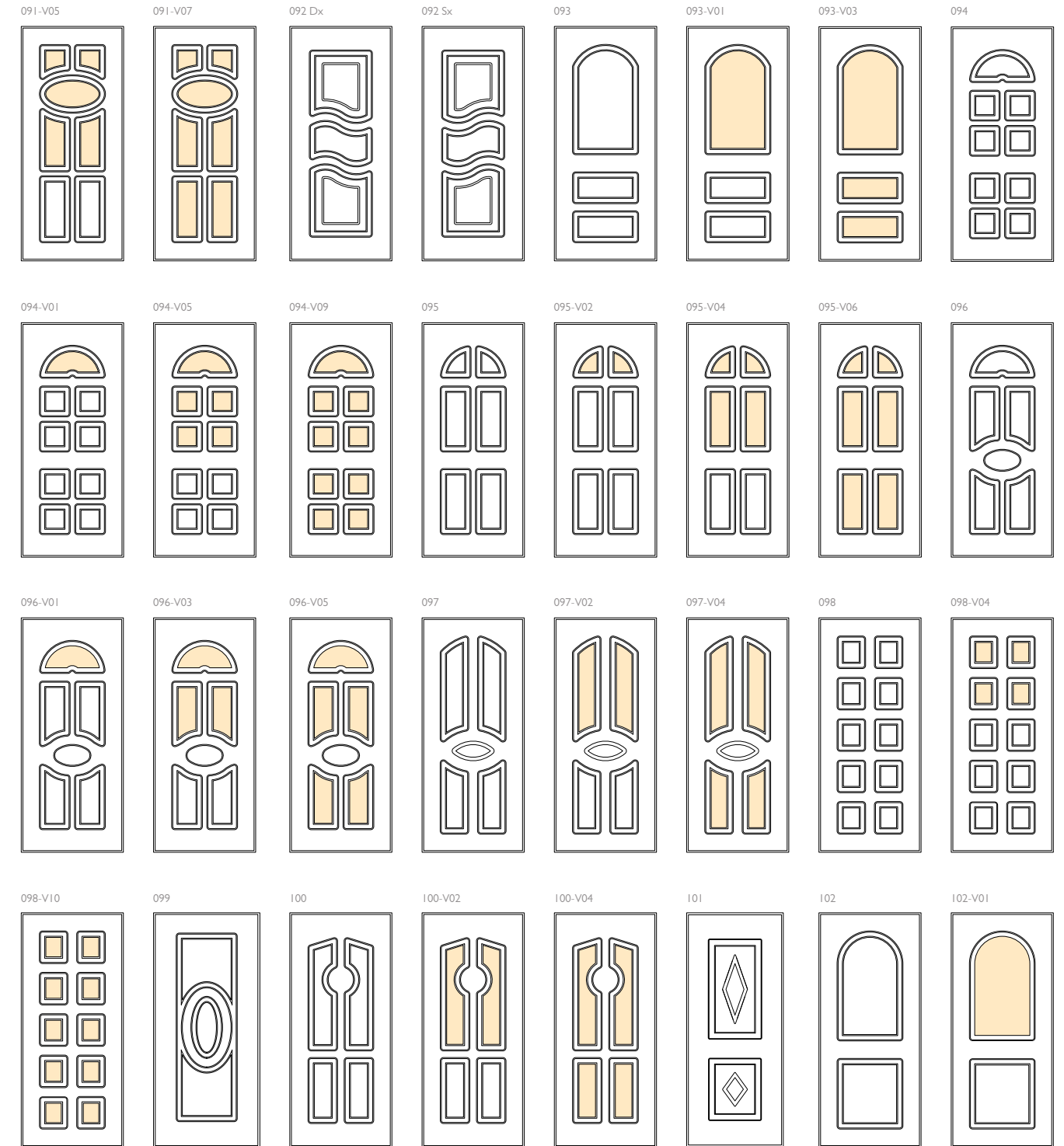
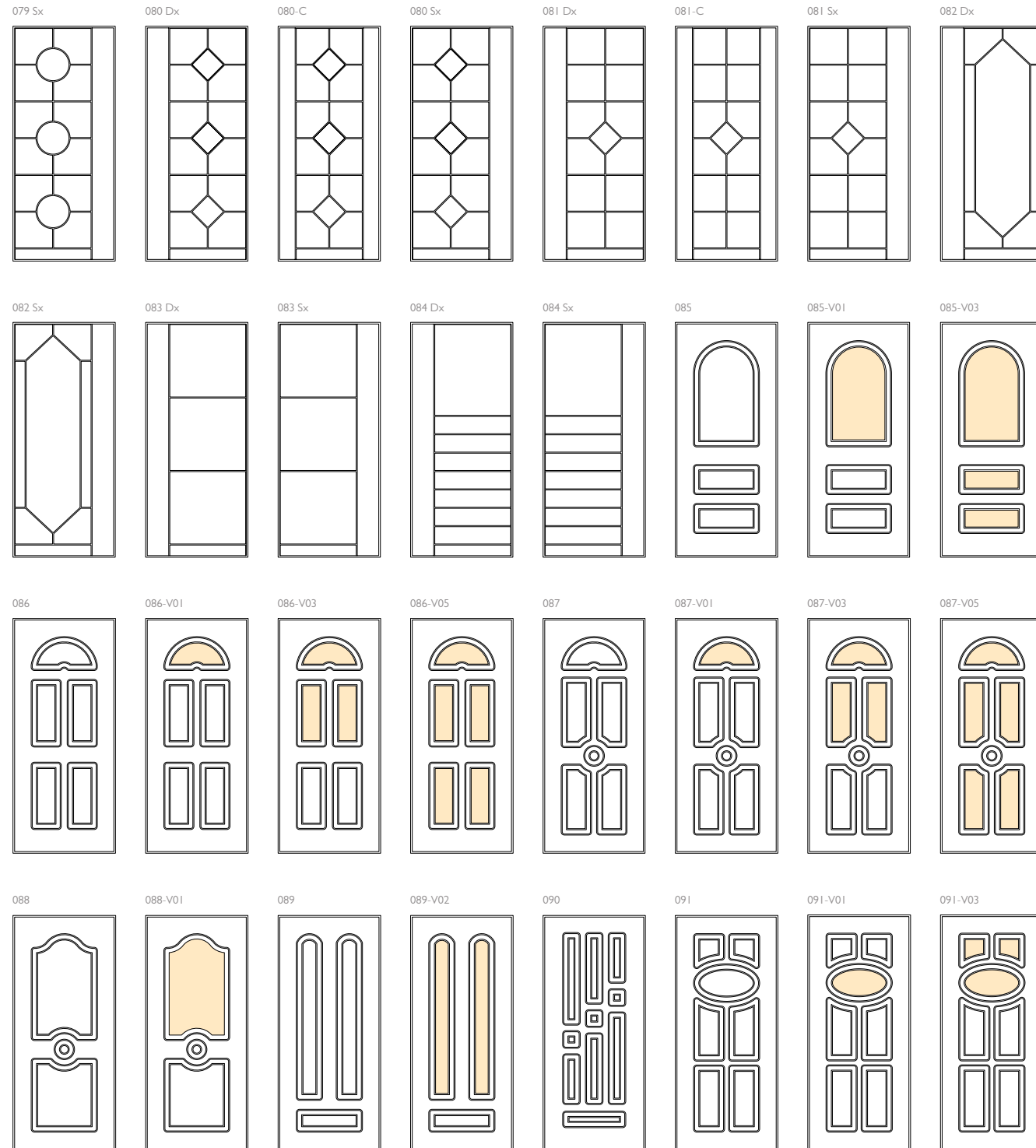



ZER@
CINQUE



ZER@
CINQUE

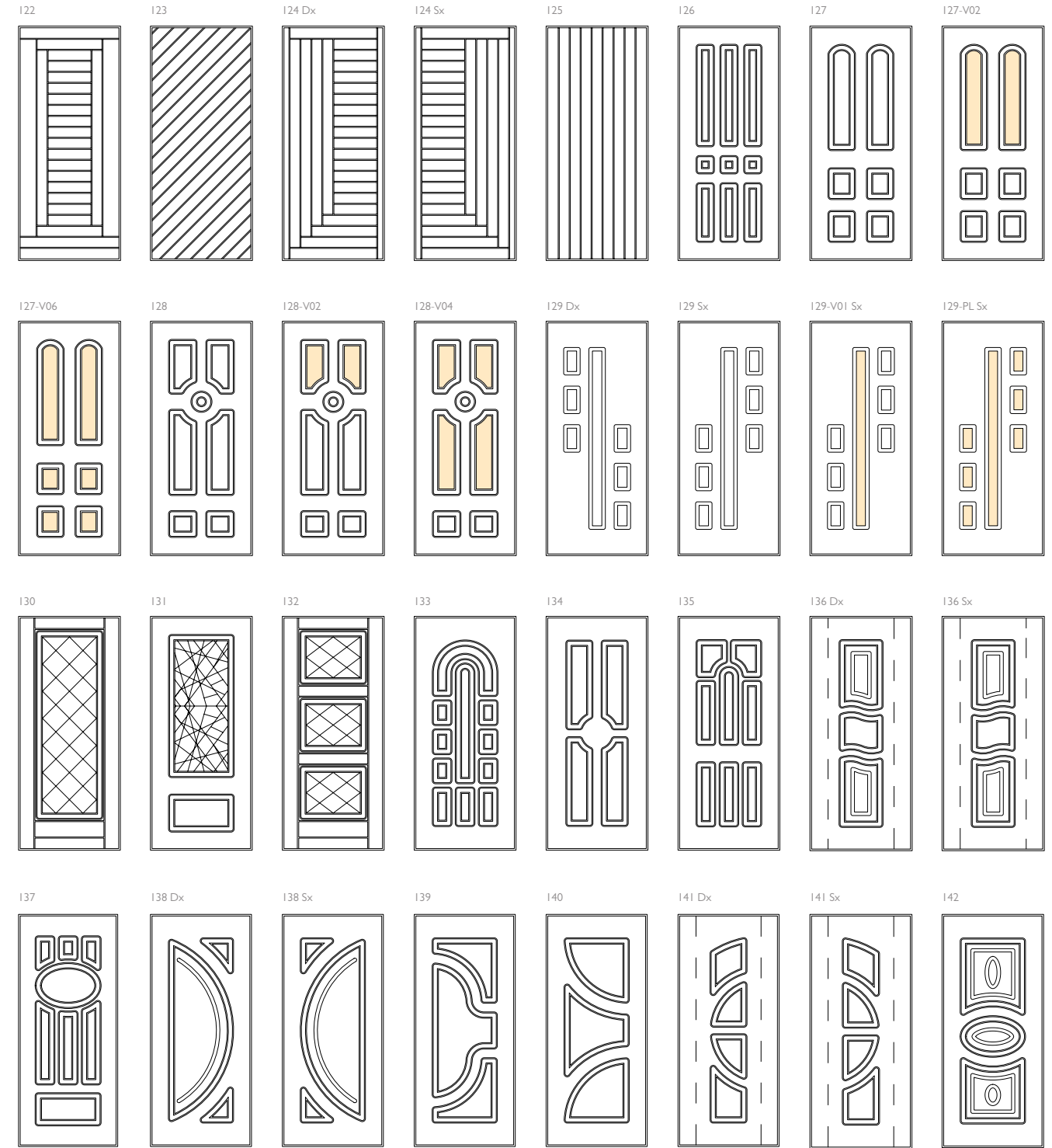
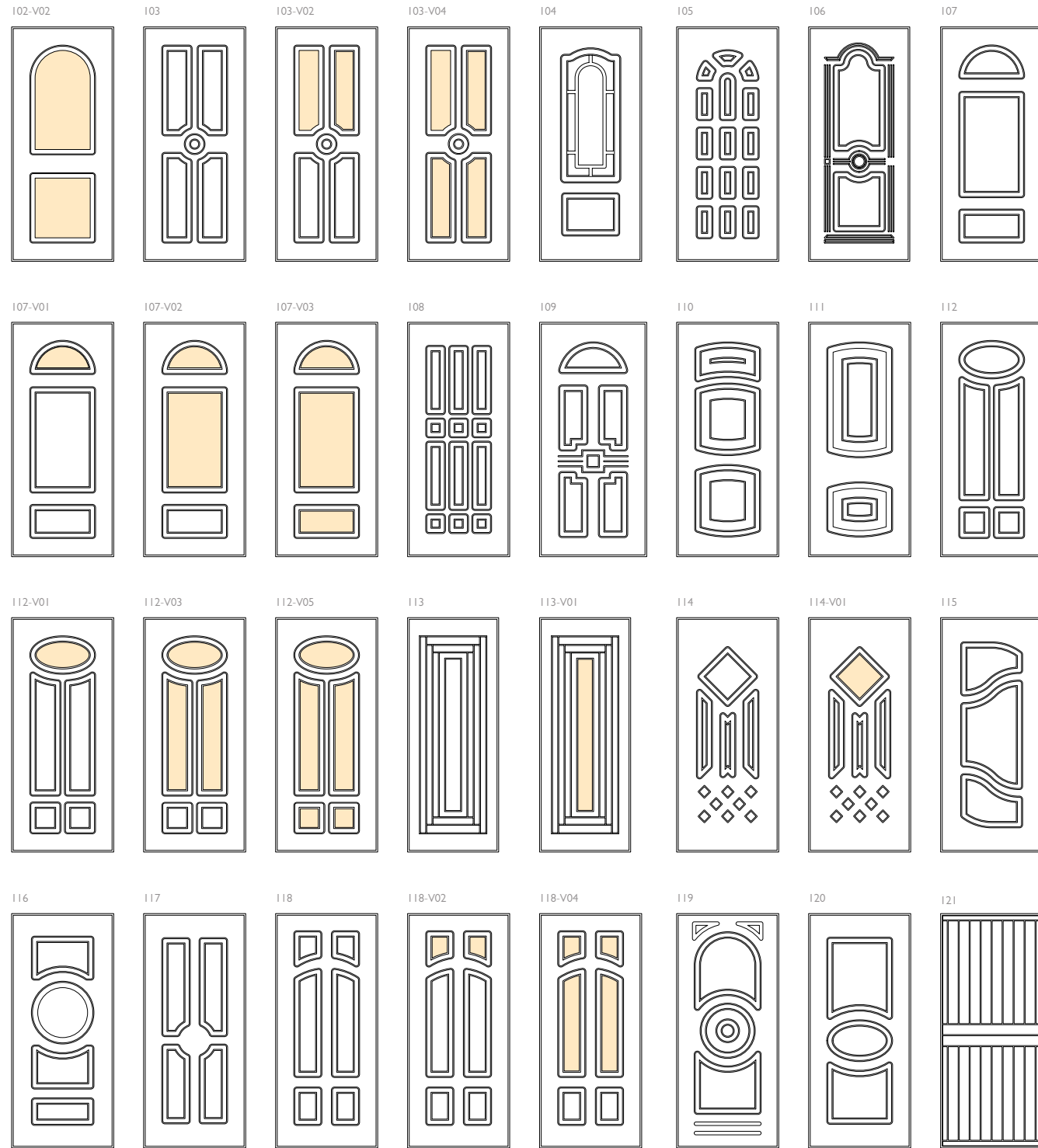



ZER@
CINQUE



ZER@
CINQUE

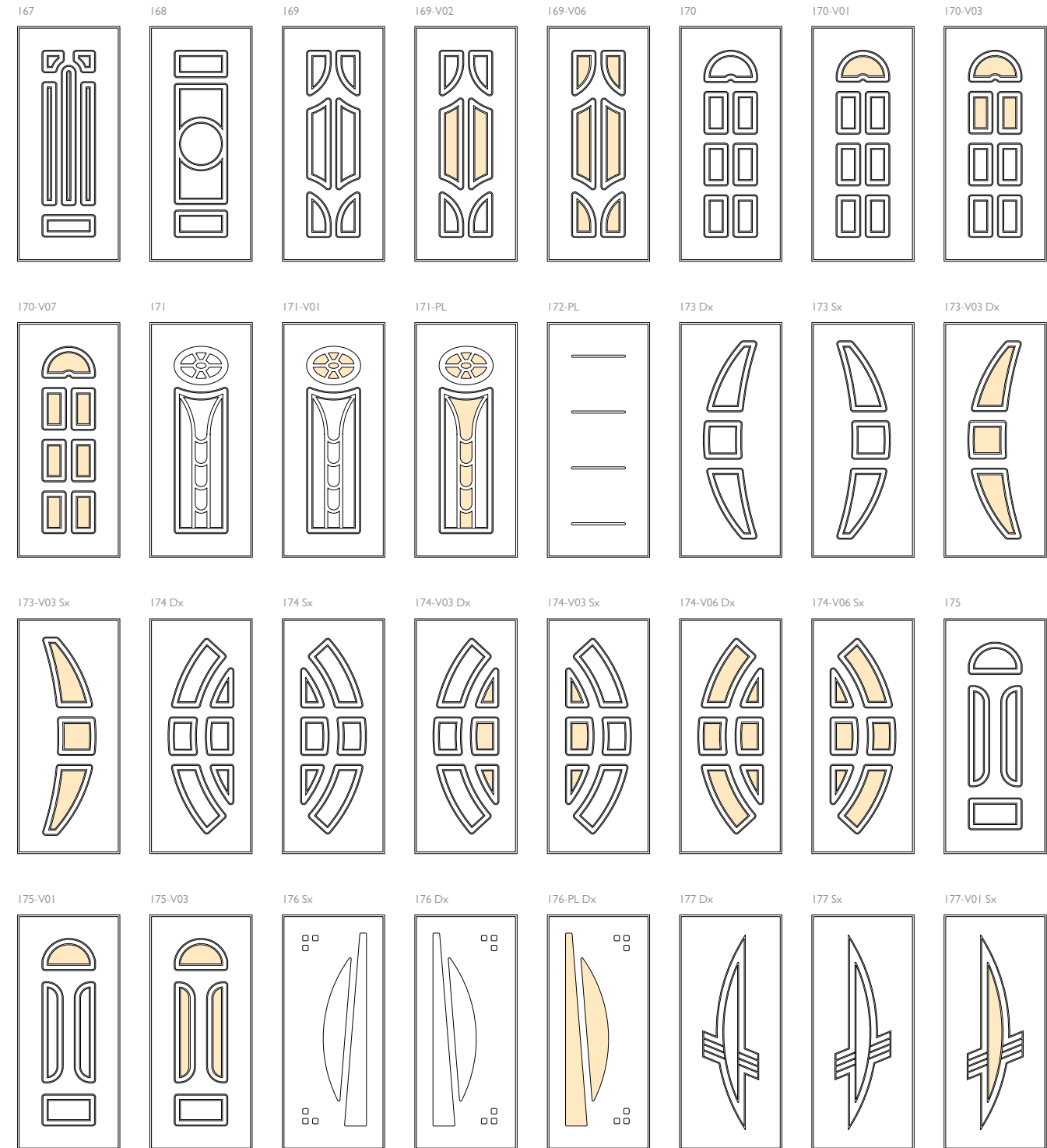
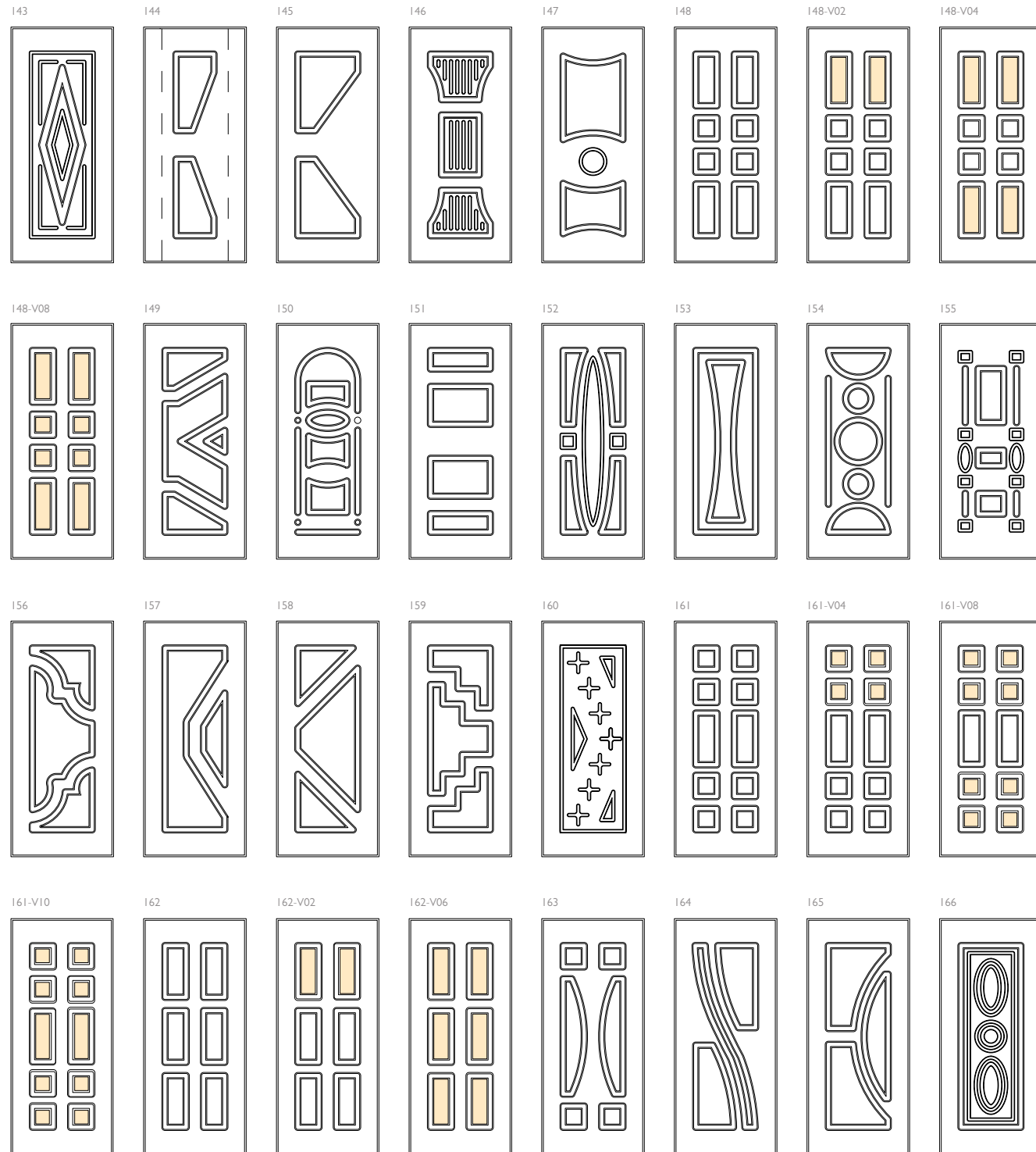

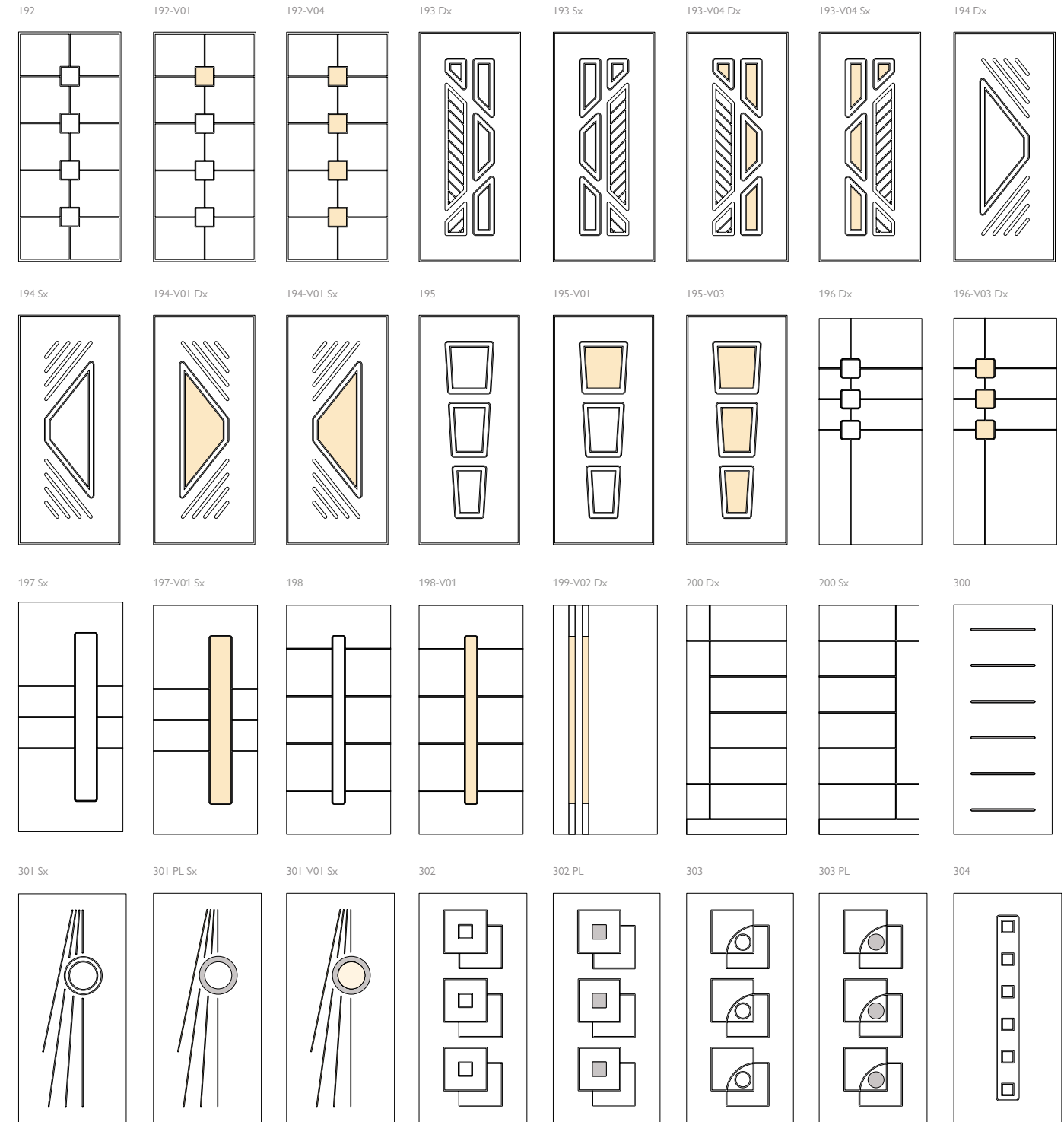
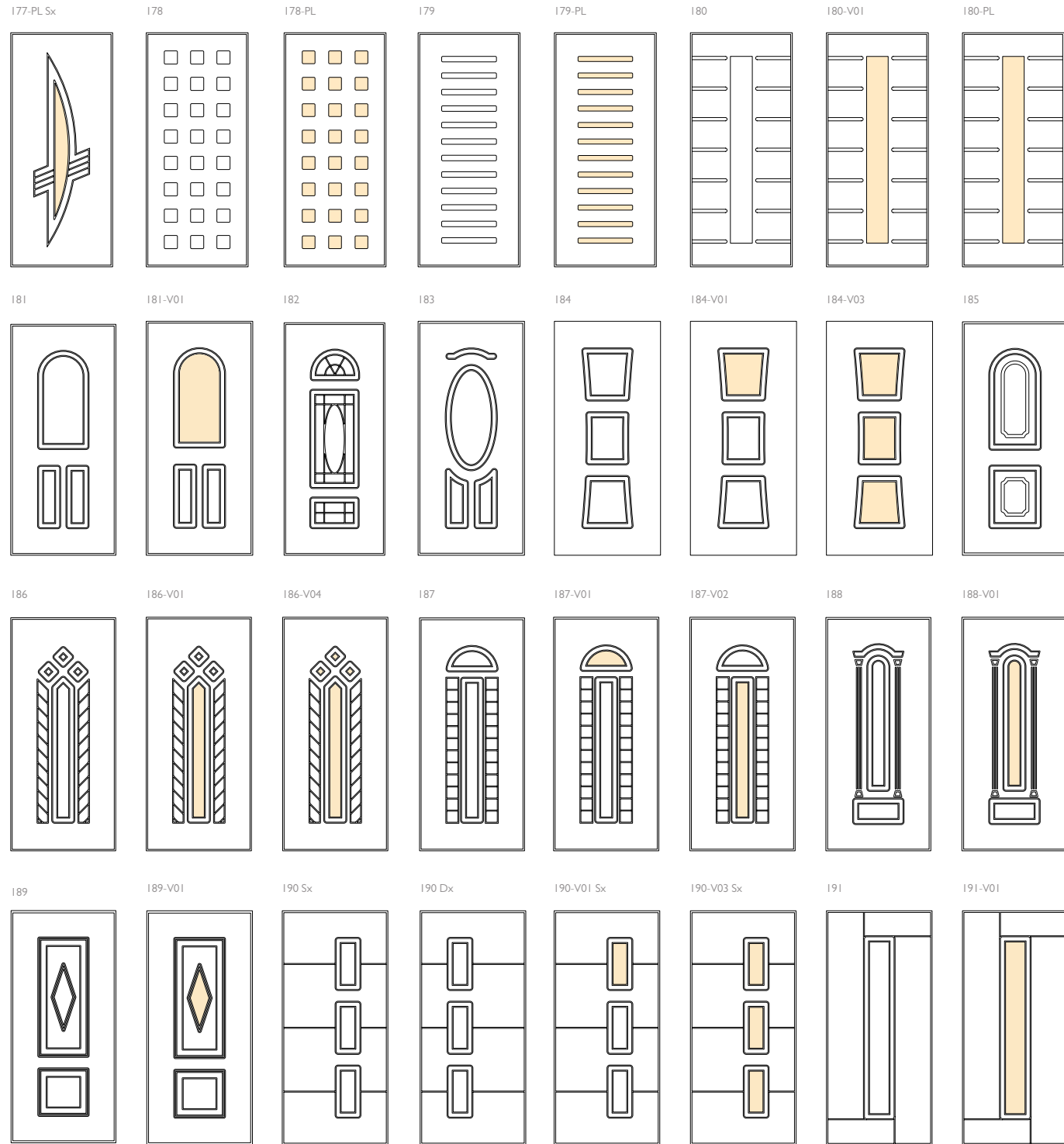



ZER@
CINQUE

ZER@
CINQUE

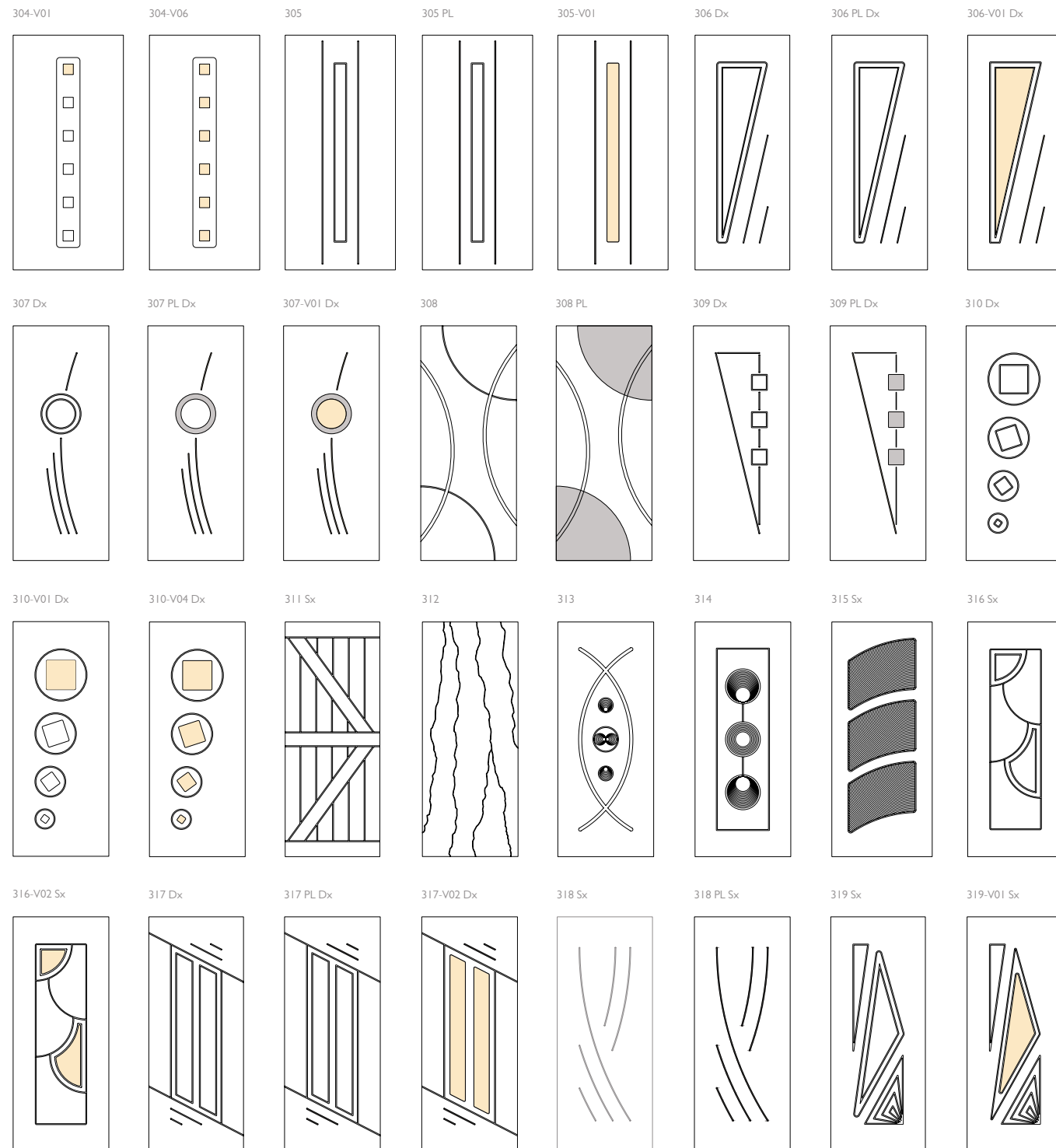



ZER@
CINQUE

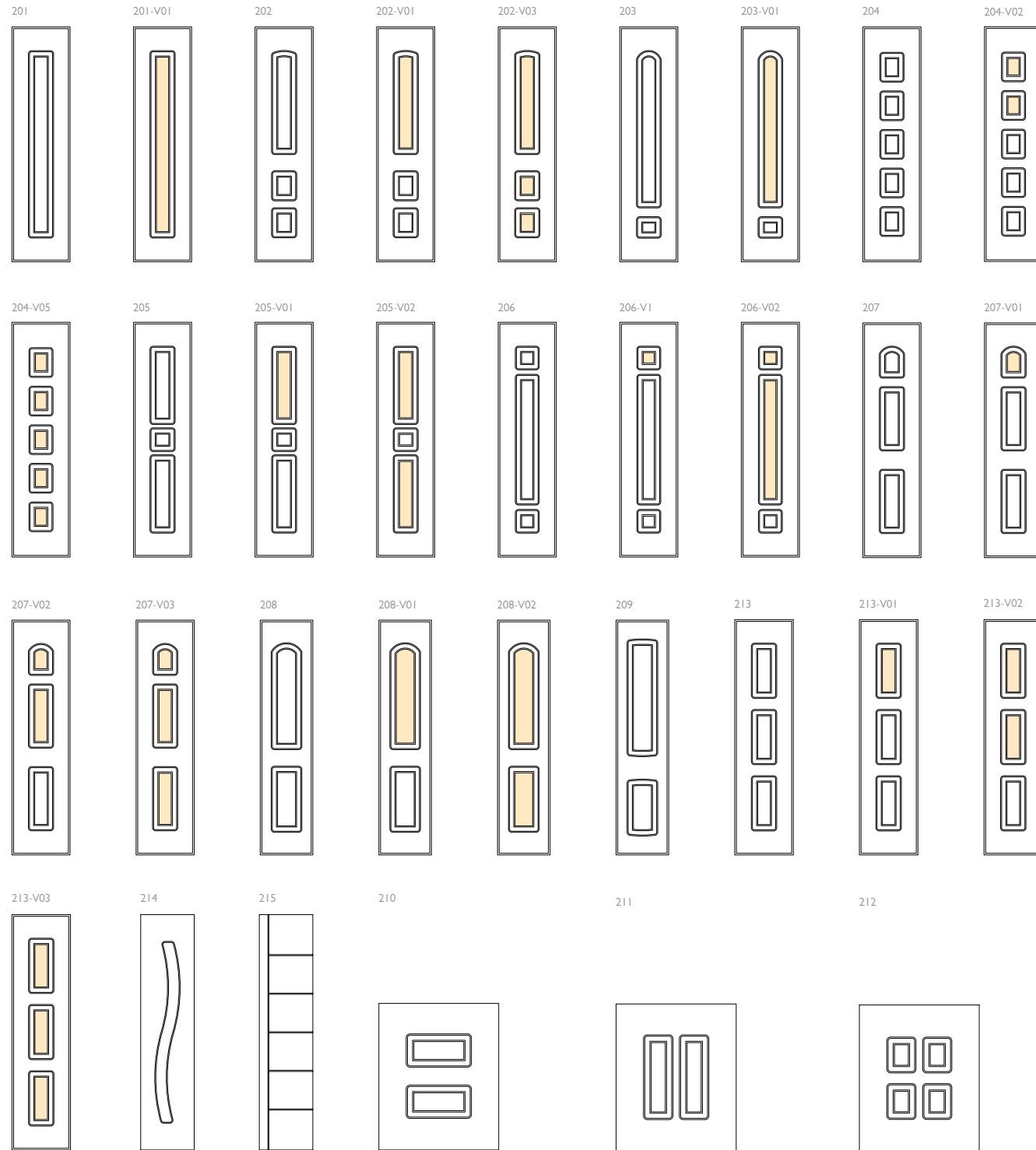

Rivenditore Autorizzato



Ital-Plastick srl

Via dell'Artigianato, 20 - 35013 Cittadella (PD) - Italy

Tel. ++39 049.9417811 - Fax ++39 049.9417812

www.italplastick.com

e-mail italplastick@italplastick.com

I colori dei pannelli rappresentati in questo catalogo, potrebbero risultare alterati nella riproduzione e stampa.
Zerocinque si riserva il diritto di modificare, in qualsiasi momento, anche senza preavviso, le caratteristiche dei vari prodotti.