

Engineering Data	Cable/Plug Attachment	Installation
Good Vacuum Practice	221	Sub D (MIL-C-24308) Plugs 229
Magnetic Properties of Metals	222	Circular (MIL-C-26482) Plugs 229
Material Temperature Limitations	222	Circular Plug MIL-C-5015 229
Properties of Ceramic Insulators	223	Thermocouple Pin Orientation 230
Thermal Expansion Curves	223	High Voltage 231
Pressure Conversion	224	Thermocouple, Spade Type 232
Dielectric Strength vs. Pressure	224	Coaxial/Plug Attachments 233
Leak Rate Conversions	226	Vacuum Cable Termination Options 234
Vacuum Ranges	226	
Wire Gauge Conversion Chart	226	
Vapor Pressure	227	
Temperature Conversion Chart	228	

GOOD VACUUM PRACTICE

Working with vacuum systems requires good vacuum practice. CeramTec recommends that the user, at a minimum, address the following items:

- Cleanliness is very important when handling any vacuum equipment. The use of clean vinyl gloves is recommended at all times. Internal surfaces of vacuum equipment should never be touched without gloves as fingerprints will contaminate the system, resulting in decreased pumping efficiency.
- Vacuum grease should be used sparingly. Silicone-based oils or grease should not be used in a system with electronically charged plates; this could insulate the charged plates.
- System components should be made of smooth, oxide-resistant, high-strength materials. The components should be smooth to keep the surface area to a minimum. Rough surfaces provide locations where gases and other contaminants will adhere. Materials that readily oxidize should not be used because oxidation will increase the surface area. Increased surface area results in decreased pumping efficiency. High-strength materials should be used to withstand the wide temperature variations associated with vacuum bakeouts. A good example of a smooth, oxide-resistant, high-strength material is 304 stainless steel.
- Raw material manufacturing processes can influence a material's compatibility with vacuum applications. CeramTec uses the best materials available. As an example, CeramTec products use ConFlat® flanges made from cross-forged or electroslag remelted 304 stainless steel. These materials provide the greatest reliability for leak free performance.

MAGNETIC PROPERTIES OF METAL

MAGNETIC (μ greater than 1.1)

Alloy 225
Alloy 405
Alloy 426
Alumel
Iron
Kovar
1010-1020 Low Carbon Steel
Monel
Nickel
42% Nickel Iron
52% Nickel Iron
430 Stainless Steel

NON-MAGNETIC (μ less than 1.1)

Alloy 11
Alloy 203
Aluminum
Constantan
Copper
Chromel
Inconel
Molybdenum
Platinum
Rhodium
302-304 Stainless Steel
Tantalum
Titanium
70% Copper-Nickel

$$\mu = \frac{\text{Absolute Permeability of Material}}{\text{Absolute Permeability of Empty Space}}$$

MATERIAL TEMPERATURE LIMITATIONS

	Maximum Load Bearing Temperature °C	Maximum Air Operating Temperature °C
Lead-Silver Solder	100	150
Silver Braze Alloys	250	450 (O ₂ permeation)
Copper Braze	300	400
Gold Braze Alloys	350	700
Copper	200	300
70% Copper-Nickel	400	500
Monel & Constantan	450	550
Nickel	500	750
Kovar (29 Ni, 17 Co, 53 Fe)	500	500
42% & 52% Nickel Iron	450	400
300 Series S.S. (304, 316, Etc.)	650	850
Inconel	550	1000
430 S.S.	500 (Vacuum, Argon)	500
Tantalum	1000 (Vacuum, Argon)	400
Molybdenum	1000 (Vacuum, Argon)	350

Lead-Silver Solder
Silver Braze Alloys
Copper Braze
Gold Braze Alloys
Copper
70% Copper-Nickel
Monel & Constantan
Nickel
Kovar (29 Ni, 17 Co, 53 Fe)
42% & 52% Nickel Iron
300 Series S.S. (304, 316, Etc.)
Inconel
430 S.S.
Tantalum
Molybdenum

100
250
300
350
200
400
450
500
500
450
650
550
500 (Vacuum, Argon)
1000 (Vacuum, Argon)
1000 (Vacuum, Argon)

150
450 (O₂ permeation)
400
700
300
500
550
750
500
400
850
1000
500
400
350

All of these charts should be used as a rough guideline to match materials with the individual application. For standard products in this catalog, the temperature ratings (limitations) can be attributed to both materials used and seal configuration.

PROPERTIES OF CERAMIC INSULATORS

	PROPERTY	UNIT	STEATITE	85% NOM. ALUMINA	94% NOM. ALUMINA	97.5% NOM. ALUMINA	99.5% NOM. ALUMINA	
Mechanical	Compressive Strength	psi, 25°C	90,000	>240,000	>300,000	>250,000	>300,000	
	Flexural Strength	psi, 25°C	21,000	46,000	50,000	43,000	45,000	
	Porosity	—	Vacuum Tight	Vacuum Tight	Vacuum Tight	Vacuum Tight	Vacuum Tight	
	Water Absorption	%	0.00	0.00	0.00	0.00	0.00	
	Hardness	Moh's Scale	7.5	8	9	9	9	
Thermal	Thermal Conductivity	cal/cm ² /sec/°C	0.008	0.035	0.049	0.064	0.070	
	Max. Operating Temp.	°C	1000	1400	1600	1650	1725	
	Thermal Expansion	in/in/°C	25-200°C	6.9×10^{-6}	5.4×10^{-6}	6.3×10^{-6}	6.9×10^{-6}	6.9×10^{-6}
	Linear Coefficient	25-600°C	7.8×10^{-6}	7.5×10^{-6}	8.0×10^{-6}	8.5×10^{-6}	8.3×10^{-6}	
Electrical	Dielectric Constant	10 MHz at 25°C	6.1	8.2	9.07	9.53	9.58	
		1 GHz at 25°C	—	8.2	9.04	9.00	9.30	
		8.5 GHz at 25°C	5.9	8.2	8.98	9.04	9.37	
	Dielectric Strength	V/mil, 60 Cycle	230	600	650	1100	800	
	Dielectric Loss Factor	10 MHz at 25°C	.0050	.0070	.00236	.00038	.00029	
		1 GHz at 25°C	—	.0100	.00560	.00270	.00130	
		8.5 GHz at 25°C	.012	—	.00700	.00407	.00084	
	Volume Resistivity	Ohms/cm ³ at 25°C	>10 ¹⁴	>10 ¹⁴	>10 ¹⁴	>10 ¹⁴	>10 ¹⁴	
300°C		10 ¹¹	10 ¹⁰	10 ¹²	10 ¹³	10 ¹¹		
600°C		10 ⁷	10 ⁷	10 ⁹	10 ¹⁰	10 ⁹		

THERMAL EXPANSION FOR INSULATORS

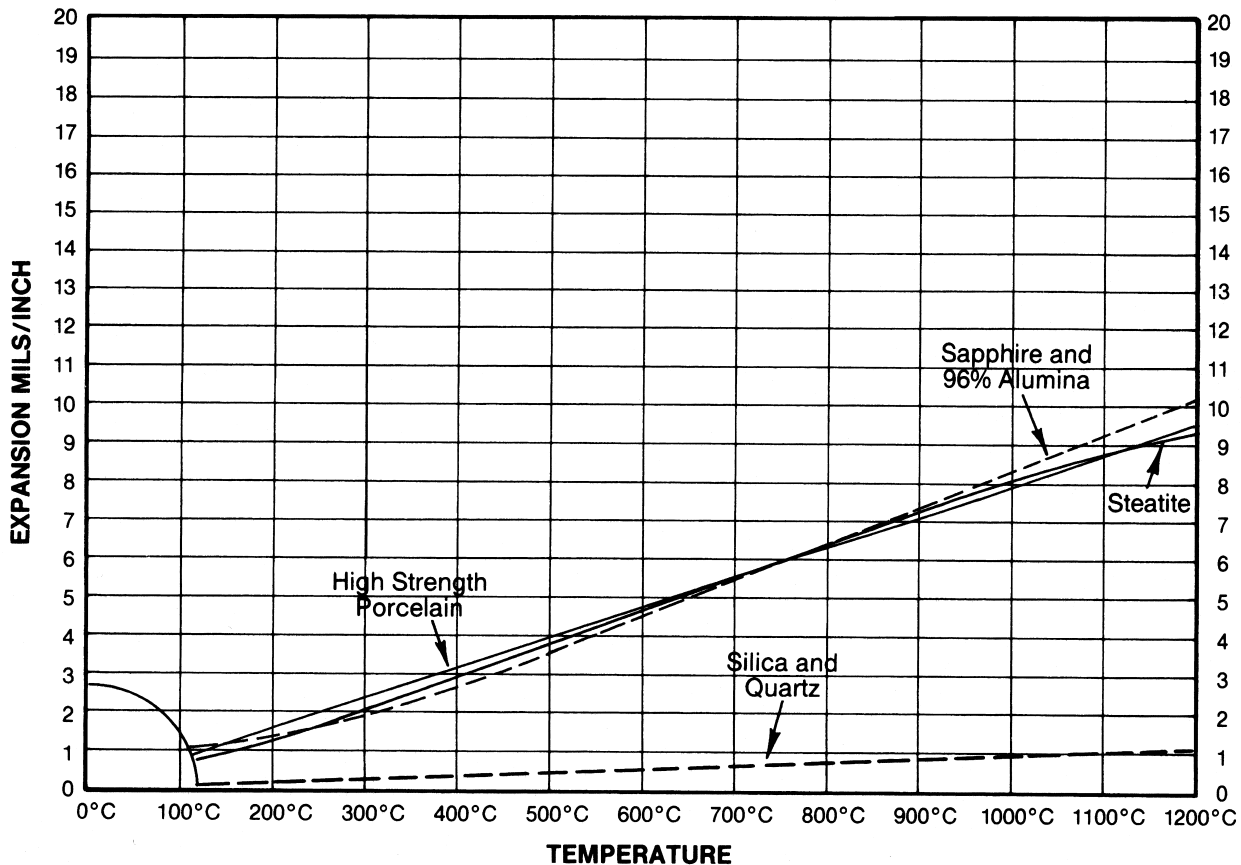

All of these charts should be used as a rough guideline to match materials with the individual application. For standard products in this catalog, the temperature ratings (limitations) can be attributed to both materials used and seal configuration.

TECHNICAL REFERENCE

THERMAL EXPANSION FOR MAGNETIC METALS

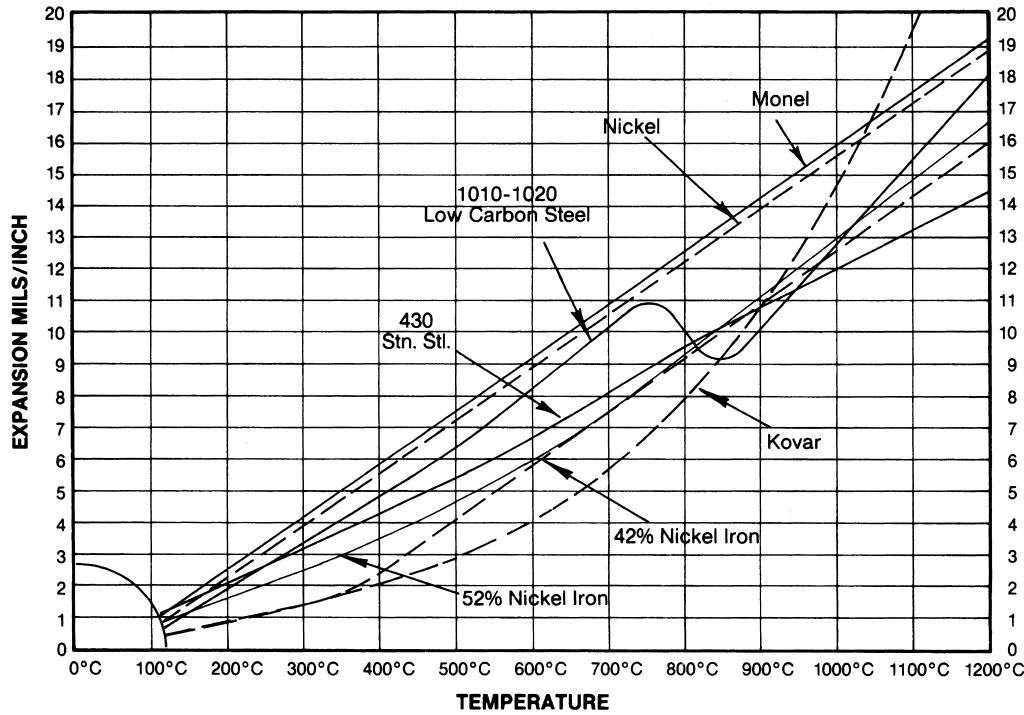

THERMAL EXPANSION FOR NON-MAGNETIC METALS

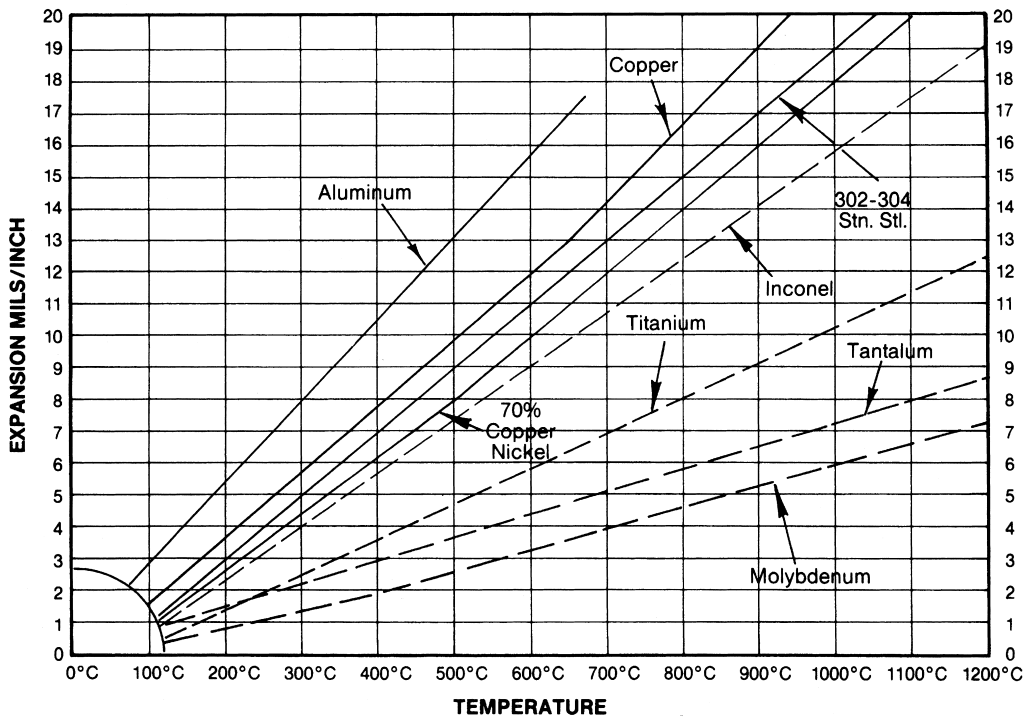

All of these charts should be used as a rough guideline to match materials with the individual application. For standard products in this catalog, the temperature ratings (limitations) can be attributed to both materials used and seal configuration.

PRESSURE CONVERSIONS

		Pa	torr	atm	mbar	psi	kg/cm ²	μ
Pascal	(newtons/m ²)	1	7.5 (10 ⁻³)	9.87 (10 ⁻⁶)	10 ⁻²	1.45 (10 ⁻⁴)	1.02 (10 ⁻⁵)	7.5
torr	(mm of mercury)	133	1	1.32 (10 ⁻³)	1.333	1.93 (10 ⁻²)	1.36 (10 ⁻³)	10 ³
atm	(atmosphere)	1.013 (10 ⁵)	760	1	1013	14.7	1.033	7.6 (10 ⁵)
mbar	(millibar)	100	0.75	9.87 (10 ⁻⁴)	1	1.45 (10 ⁻²)	1.02 (10 ⁻³)	750.1
psi	(lb/in ²)	6.89 (10 ³)	51.71	6.8 (10 ⁻²)	68.9	1	0.070	5.17 (10 ⁴)
kg/cm²		9.81 (10 ⁴)	735.6	0.968	981	14.2	1	7.35 (10 ⁵)
μ	(micron)	0.1333	10 ⁻³	1.32 (10 ⁻⁶)	1.333(10 ⁻³)	1.93 (10 ⁻⁵)	1.359 (10 ⁻⁶)	1

	kPa	lb/sq in	lb/sq ft	atm	kg/cm ²	mm Hg at 32°F	in Hg at 32°F	ft water at 39.2°F
1 kPa	1	0.145	20.92	9.9 (10 ⁻³)	0.0102	7.519	0.295	0.335
1 lb/sq in	6.895	1	144	...	0.0703	51.713	2.036	2.307
1 lb/sq ft	0.048	6.94 (10 ⁻³)	1	0.3591	0.014	0.016
1 atmosphere	101.3	14.696	2116.2	1	1.0333	760	29.921	33.9
1 kg/cm²	98.07	14.223	2048.1	0.9678	1	735.56	28.958	32.81
1 torr	0.133	0.0193	2.785	1	0.039	0.045
1 in mercury	3.387	0.4912	70.73	0.0334	0.0345	25.4	1	1.133
1 ft water	2.984	0.4335	62.42	...	0.0305	22.418	0.883	1

DIELECTRIC STRENGTH VS. PRESSURE

**Pressure PSIG
Chart#1**

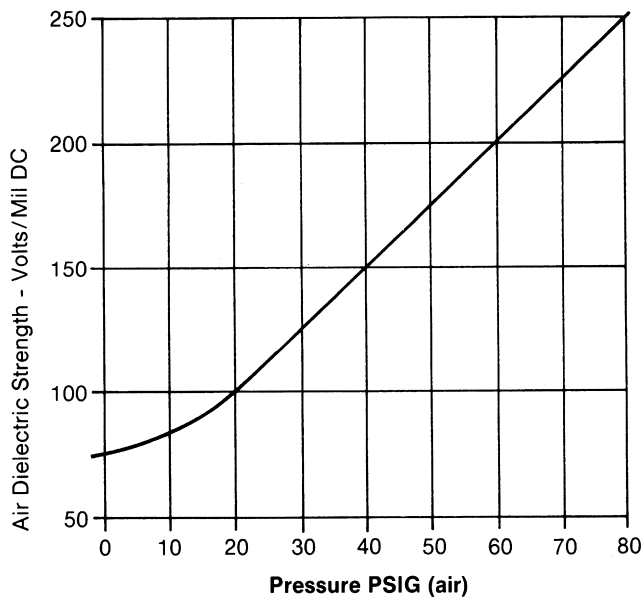

**Pressure Torr
Chart#2**

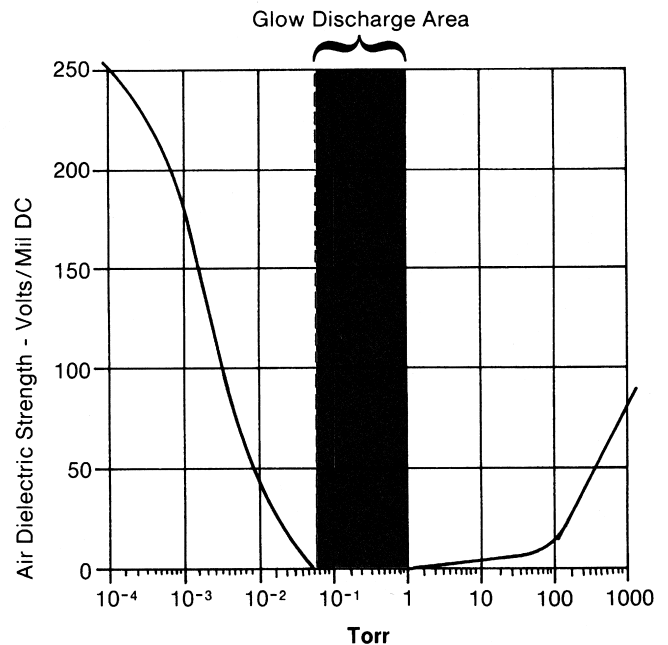

The voltage ratings are dependent upon system pressure. Catalog ratings are given at a system pressure of 10⁻⁴ torr or 80 PSIG air. For rating at system pressures between these points, the charts shown may be used to determine the approximate derating required. Voltage rating at pressures less than 10⁻⁴ torr or greater than 80 PSIG air is the same as at 10⁻⁴ torr or 80 PSIG since the voltage is limited by the external ambient air at normal atmospheric conditions.

TECHNICAL REFERENCE

THROUGHPUT AND LEAK RATE

	Pa•m ³ /s	torr•l/s	atm cm ³ /s or std cc/s	μl/s	ft ³ (STP)/h
1 Pa•m³/s	1.0	7.5	9.87	7.50 (10 ³)	1.26
1 torr•l/s	0.133	1.0	1.32	10 ³	0.168
1 atm cm³/s or 1 std cc/s	0.101	0.76	1.0	760	127 (10 ⁻³)
1 μl/s	1.3 (10 ⁻⁴)	10 ⁻³	1.32 (10 ⁻³)	1.0	11.68 (10 ⁻⁴)
1 ft³ (STP)/h	0.794	5.96	787	5960	1.0

VACUUM RANGES

Rough (Low) Vacuum	759 to 1 X 10 ⁻³ torr (approx.)
High Vacuum	1 X 10 ⁻³ to 1 X 10 ⁻⁸ torr (approx.)
Ultra-High Vacuum	Less than 1 X 10 ⁻⁸ torr

WIRE GAUGE CONVERSION CHART

S.W.G. (inches)	Wire No. (Gauge)	A.W.G. or B&S (inches)	A.W.G. Metric (MM)	S.W.G. (inches)	Wire No. (Gauge)	A.W.G. or B&S (inches)	A.W.G. Metric (MM)	S.W.G. (inches)	Wire No. (Gauge)	A.W.G. or B&S (inches)	A.W.G. Metric (MM)
0.500	0000000 (7/0)	0.0920	13	0.0720	1,829	0.0092	34	0.0063	0,1601
0.464	000000 (6/0)	0.580000	0.0800	14	0.0641	1,628	0.0084	35	0.0056	0,1422
0.432	00000 (5/0)	0.516500	0.0720	15	0.0571	1,450	0.0076	36	0.0050	0,1270
0.400	0000 (4/0)	0.460000	11,684	0.0640	16	0.0508	1,291	0.0068	37	0.0045	0,1143
0.372	000 (3/0)	0.409642	10,404	0.0560	17	0.0453	1,150	0.0060	38	0.0040	0,1016
0.348	00 (2/0)	0.364796	9,266	0.0480	18	0.0403	1,024	0.0052	39	0.0035	0,0889
0.324	0 (1/0)	0.324861	8,252	0.0400	19	0.0359	0,9119	0.0048	40	0.0031	0,0787
0.300	1	0.289297	7,348	0.0360	20	0.0320	0,8128	0.0044	41	0.0028	0,0711
0.276	2	0.257627	6,543	0.0320	21	0.0285	0,7239	0.0040	42	0.0025	0,0635
0.252	3	0.229423	5,827	0.0280	22	0.0253	0,6426	0.0036	43	0.0022	0,0559
0.232	4	0.2043	5,189	0.0240	23	0.0226	0,5740	0.0032	44	0.0020	0,0508
0.2120	5	0.1819	4,621	0.0220	24	0.0201	0,5106	0.0028	45	0.0018	0,0457
0.1920	6	0.1620	4,115	0.0200	25	0.0179	0,4547	0.0024	46	0.0016	0,0406
0.1760	7	0.1443	3,665	0.0180	26	0.0159	0,4038	0.0020	47	0.0014	0,0350
0.1600	8	0.1285	3,264	0.0164	27	0.0142	0,3606	0.0016	48	0.0012	0,0305
0.1440	9	0.1144	2,906	0.0148	28	0.0126	0,3200	0.0012	49	0.0011	0,0279
0.1280	10	0.1019	2,588	0.0136	29	0.0113	0,2870	0.0010	50	0.0010	0,0254
0.1160	11	0.0907	2,304	0.0124	30	0.0100	0,2540		51	0.00088	0,0224
0.1040	12	0.0808	2,052	0.0116	31	0.0089	0,2261		52	0.00078	0,0198
				0.0108	32	0.0080	0,2032		53	0.00070	0,0178
				0.0100	33	0.0071	0,1803		54	0.00062	0,0158
									55	0.00055	0,0140
									56	0.00049	0,0124

TECHNICAL REFERENCE

VAPOR PRESSURES OF ELEMENTS

Element	VAPOR PRESSURE (mm Hg)						mp (°C)
	10 ⁻⁵ at °C	10 ⁻⁴ at °C	10 ⁻³ at °C	10 ⁻² at °C	10 ⁻¹ at °C	1 at °C	
Aluminum	882	972	1082	1207	1347	1547	659
Antimony	382	427	477	542	617	757	630
Barium	417	467	537	617	727	867	710
Beryllium	902	987	1092	1212	1367	1567	1283
Bismuth	450	508	578	661	762	892	271
Cadmium	149	182	221	267	321	392	321
Calcium	402	452	517	592	687	817	850
Carbon	1977	2107	2247	2427	2627	2867	—
Cesium	46	75	110	152	206	277	30
Chromium	1062	1162	1267	1392	1557	1737	1903
Cobalt	1162	1262	1377	1517	1697	1907	1495
Copper	942	1032	1142	1272	1427	1622	1084
Gold	987	1082	1197	1332	1507	1707	1063
Indium	670	747	837	947	1077	1242	156
Iridium	1797	1947	2107	2307	2527	2827	2454
Iron	1107	1207	1322	1467	1637	1847	1539
Lead	487	551	627	719	832	977	328
Lithium	348	399	460	534	623	737	181
Magnesium	287	330	382	442	517	612	650
Manganese	697	767	852	947	1067	1227	1244
Mercury	-28	-8	16	45	81	125	-39
Molybdenum	1987	2167	2377	2627	2927	3297	2577
Nickel	1142	1247	1357	1497	1667	1877	1452
Osmium	2101	2264	2451	2667	2920	3221	2697
Palladium	1157	1262	1387	1547	1727	1967	1550
Platinum	1602	1742	1907	2077	2317	2587	1770
Potassium	91	123	162	208	266	341	64
Rubidium	64	95	133	176	228	300	39
Silicon	1177	1282	1357	1547	1717	1927	1415
Silver	757	832	922	1032	1167	1337	961
Sodium	158	195	238	290	355	437	98
Strontium	342	394	456	531	623	742	770
Tantalum	2397	2587	2807	3067	3372	3737	2997
Thorium	1686	1831	1999	2196	2431	2715	1827
Tin	882	977	1092	1227	1397	1612	232
Tungsten	2547	2757	3007	3297	3647	—	3377
Uranium	1442	1582	1737	1927	2157	2447	1130
Zinc	208	246	290	342	405	485	420
Zirconium	1837	2002	2187	2397	2647	2977	1852

Table reprinted from: *Basic Vacuum Practice*, third edition (1992), Varian Associates, Lexington, Mass.

NOTE: The numbers in **boldface** refer to the temperature in degrees, either Centigrade or Fahrenheit, which it is desired to convert into the other scale. If converting from F° to C°, the equivalent temperature will be found in the left column; while if converting from C° to F°, the answer will be found in the column on the right.

Centigrade	Fahrenheit	Centigrade	Fahrenheit	Centigrade	Fahrenheit	Centigrade	Fahrenheit	Centigrade	Fahrenheit				
-223.3	-370	-70.6	-95	-139	2.2	36	96.8	32.8	91	195.8	288	550	1022
-220.6	-365	-67.8	-90	-130	2.8	37	98.6	33.3	92	197.6	293	560	1040
-217.8	-360	-65.0	-85	-121	3.3	38	100.4	33.9	93	199.4	299	570	1058
-215.0	-355	-62.2	-80	-112.0	3.9	39	102.2	34.4	94	201.2	304	580	1076
-212.2	-350	-59.4	-75	-103.0	4.4	40	104.0	35.0	95	203.0	310	590	1094
-209.4	-345	-56.7	-70	-94.0	5.0	41	105.8	35.6	96	204.8	316	600	1112
-206.7	-340	-53.9	-65	-85.0	5.6	42	107.6	36.1	97	206.6	321	610	1130
-203.9	-335	-51.1	-60	-76.0	6.1	43	109.4	36.7	98	208.4	327	620	1148
-201.1	-330	-48.3	-55	-67.0	6.7	44	111.2	37.2	99	210.2	332	630	1166
-198.3	-325	-45.6	-50	-58.0	7.2	45	113.0	37.8	100	212.0	338	640	1184
-195.6	-320	-42.8	-45	-49.0	7.8	46	114.8	43	110	230	343	650	1202
-192.8	-315	-40.0	-40	-40.0	8.3	47	116.6	49	120	248	349	660	1220
-190.0	-310	-37.2	-35	-31.0	8.9	48	118.4	54	130	266	354	670	1238
-187.2	-305	-34.4	-30	-22.0	9.4	49	120.2	60	140	284	360	680	1256
-184.4	-300	-31.7	-25	-13.0	10.0	50	122.0	66	150	302	366	690	1274
-181.7	-295	-28.9	-20	-4.0	10.6	51	123.8	71	160	320	371	700	1292
-178.9	-290	-26.1	-15	5.0	11.1	52	125.6	77	170	338	377	710	1310
-176.1	-285	-23.3	-10	14.0	11.7	53	127.4	82	180	356	382	720	1328
-173.3	-280	-20.6	-5	23.0	12.2	54	129.2	88	190	374	388	730	1346
-170.6	-275	-17.8	0	32.0	12.8	55	131.0	93	200	392	393	740	1364
-167.8	-270	-17.2	1	33.8	13.3	56	132.8	99	210	410	399	750	1382
-165.0	-265	-16.7	2	35.6	13.9	57	134.6	100	212	414	404	760	1400
-162.2	-260	-16.1	3	37.4	14.4	58	136.4	104	220	428	410	770	1418
-159.4	-255	-15.6	4	39.2	15.0	59	138.2	110	230	446	416	780	1436
-156.7	-250	-15.0	5	41.0	15.6	60	140.0	116	240	464	421	790	1454
-153.9	-245	-14.4	6	42.8	16.1	61	141.8	121	250	482	427	800	1472
-151.1	-240	-13.9	7	44.6	16.7	62	143.6	127	260	500	432	810	1490
-148.3	-235	-13.3	8	46.4	17.2	63	145.4	132	270	518	438	820	1508
-145.6	-230	-12.8	9	48.2	17.8	64	147.2	138	280	536	443	830	1526
-142.8	-225	-12.2	10	50.0	18.3	65	149.0	143	290	554	449	840	1544
-140.0	-220	-11.7	11	51.8	18.9	66	150.8	149	300	572	454	850	1562
-137.2	-215	-11.1	12	53.6	19.4	67	152.6	154	310	590	460	860	1580
-134.4	-210	-10.6	13	55.4	20.0	68	154.4	160	320	608	466	870	1598
-131.7	-205	-10.0	14	57.2	20.6	69	156.2	166	330	626	471	880	1616
-128.9	-200	-9.4	15	59.0	21.1	70	158.0	171	340	644	477	890	1634
-126.1	-195	-8.9	16	60.8	21.7	71	159.8	177	350	662	482	900	1652
-123.3	-190	-8.3	17	62.6	22.2	72	161.6	182	360	680	488	910	1670
-120.6	-185	-7.8	18	64.4	22.8	73	163.4	188	370	698	493	920	1688
-117.8	-180	-7.2	19	66.2	23.3	74	165.2	193	380	716	499	930	1706
-115.0	-175	-6.7	20	68.0	23.9	75	167.0	199	390	734	504	940	1724
-112.2	-170	-6.1	21	69.8	24.4	76	168.8	204	400	752	510	950	1742
-109.4	-165	-5.6	22	71.6	25.0	77	170.6	210	410	770	516	960	1760
-106.7	-160	-5.0	23	73.4	25.6	78	172.4	216	420	788	521	970	1778
-103.9	-155	-4.4	24	75.2	26.1	79	174.2	221	430	806	527	980	1796
-101.1	-150	-3.9	25	77.0	26.7	80	176.0	227	440	824	532	990	1814
-98.3	-145	-3.3	26	78.8	27.2	81	177.8	232	450	842	538	1000	1832
-95.6	-140	-2.8	27	80.6	27.8	82	179.6	238	460	860	566	1050	1922
-92.8	-135	-2.2	28	82.4	28.3	83	181.4	243	470	878	593	1100	2012
-90.0	-130	-1.7	29	84.2	28.9	84	183.2	249	480	896	621	1150	2102
-87.2	-125	-1.1	30	86.0	29.4	85	185.0	254	490	914	649	1200	2192
-84.4	-120	-0.6	31	87.8	30.0	86	186.8	260	500	932	677	1250	2282
-81.7	-115	0.0	32	89.6	30.6	87	188.6	266	510	950	704	1300	2372
-78.9	-110	0.6	33	91.4	31.1	88	190.4	271	520	968	732	1350	2462
-76.1	-105	1.1	34	93.2	31.7	89	192.2	277	530	986	760	1400	2552
-73.3	-100	1.7	35	95.0	32.2	90	194.0	282	540	1004	788	1450	2642
											816	1500	2732

The formulas at the right may also be used for converting Centigrade or Fahrenheit degrees into the other scales.

$$\text{Degrees Cent., } C^{\circ} = \frac{5}{9} (F^{\circ} + 40) - 40$$

$$\text{Degrees Fahr., } F^{\circ} = \frac{5}{9} (C^{\circ} + 40) - 40$$

$$\text{Degrees Kelvin, } K^{\circ} = C^{\circ} + 273.18$$

$$\text{Degrees Rankine, } R^{\circ} = F^{\circ} + 459.72$$

SUB D MIL-C-24308 TYPE

Air Side Plug

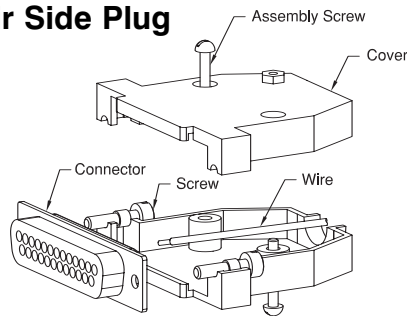

Solder wires to solder cup contacts. Insert connector between 2-piece housing. Assemble with included screws and nuts.

Vacuum Side Plug

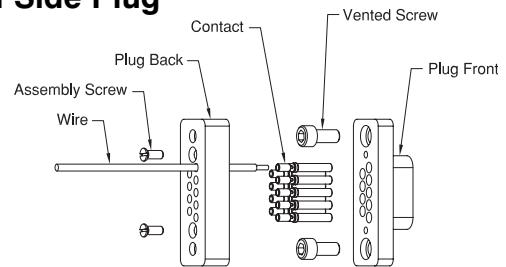

Feed wiring through plug back prior to crimping. Crimp wire to contact. Use crimp tool #2840-05. Insert two 4-40 vented socket head cap screws into counterbores in plug front. Insert contacts into holes in plug front. Align plug back with plug front. Insert assembly screws and tighten.

CIRCULAR MIL-C-26482 TYPE (200°C Max.)

Circular Multipin and Thermocouple

Air Side Plug

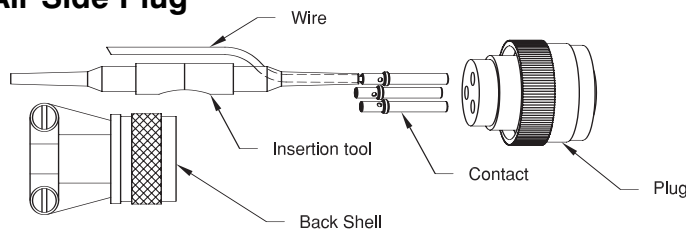

Crimp wire to contact and insert through back shell. Place wire / contact on end of insertion tool. Starting at center of plug insert contact / wire.

Vacuum Side Plug

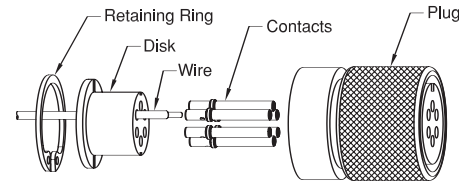

Insert wires through disk and crimp to contacts. Use crimp tool #2840-05. After crimping seat contacts on disk. Align contacts with holes in plug and insert. Insert retaining ring into back of plug to secure disk in place.

CIRCULAR MIL-C-5015 TYPE (125°C Max.)

Instrumentation

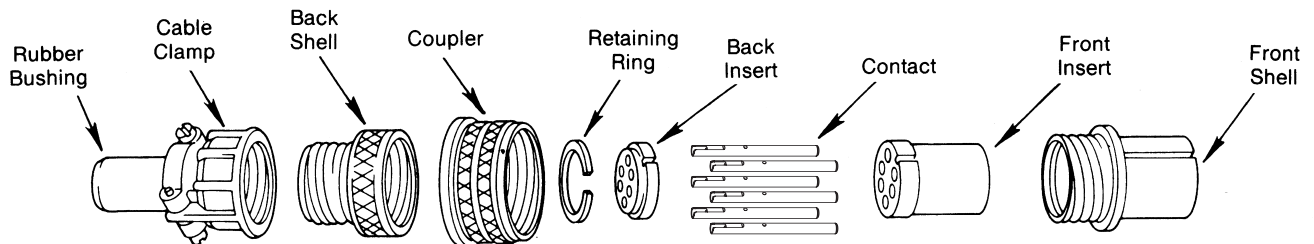

Note: Assembly instructions for the 4, 6, 10, 20 and 35 conductor and extended range plugs are identical.

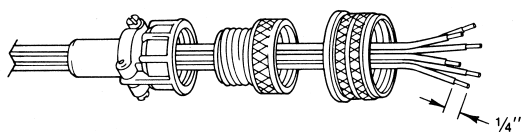

STEP 1 . . . Slide the cable clamp, rubber bushing, back shell and coupler over the cable. Strip the ends of the wires to the dimension shown.

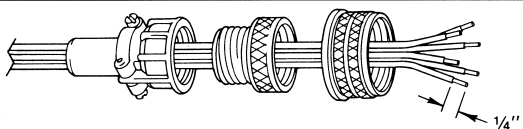

STEP 2 . . . Insert the proper wires into the contacts within the front shell and solder in place with the 60-40 rosin core solder. Snap ring and rear insulator can be removed, which would allow contacts to be more easily soldered.

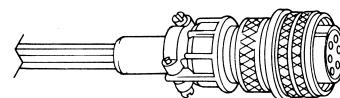

STEP 3 . . . Slide the coupler over the front shell, then thread the back shell onto the front shell and tighten. Slide the rubber bushing inside the cable clamp. Thread the cable clamp onto the back shell and tighten. Moderately tighten the clamp on the cable.

CIRCULAR MIL-C-5015 TYPE (125°C Max.)

Thermocouple

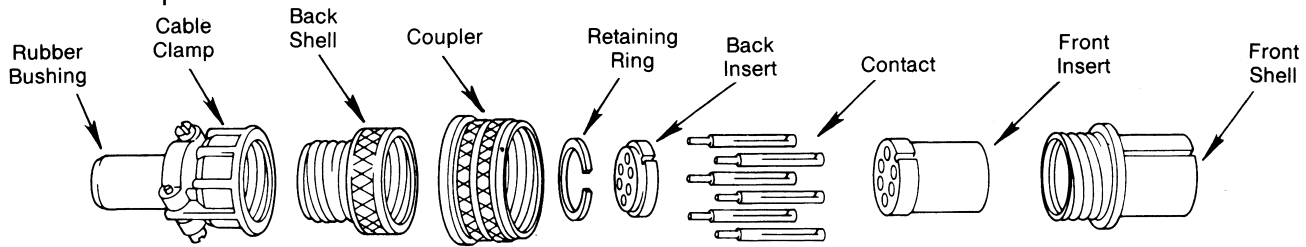

Note: Assembly instructions for the 2, 3, 5, and 10 pair thermocouple and extended range plugs are identical.

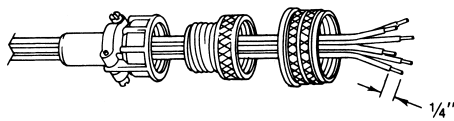

STEP 1 . . . Slide the cable clamp, rubber bushing, back shell and coupler over the cable. Strip the ends of the wires to the dimension shown.

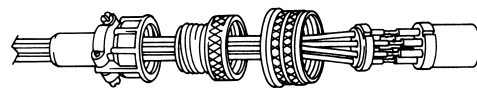

STEP 3 . . . Insert the contacts into the correct holes of the front insert. Notice that the alignment slots are in line upon assembly.

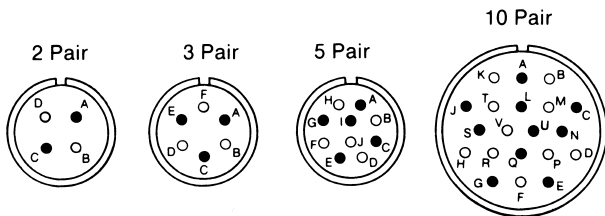

THERMOCOUPLE LEAD IDENTIFICATION
Darkened circles indicate placement of the positive (+) thermocouple leads and the empty circles indicate placement of the negative (-) thermocouple leads.

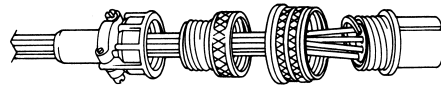

STEP 4 . . . Slide the front and back inserts together and insert them into the front shell. Secure them in place with the retaining ring.

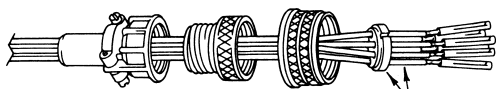

See Lead Orientation Charts Above

STEP 2 . . . Insert the proper thermocouple material into the properly identified holes in the back insert. Slide the proper contact on its corresponding conductor and crimp in place as shown.

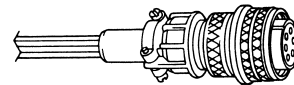

STEP 5 . . . Slide the coupler over the front shell, then thread the back shell onto the front shell and tighten. Slide the rubber bushing inside the cable clamp. Thread the cable clamp onto the back shell and tighten. Moderately tighten the clamp on the cable.

Thermocouple Header Pin Orientation

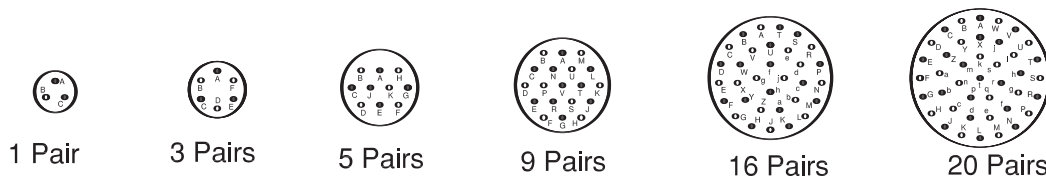

Darkened circles indicate placement of the positive (+) thermocouple leads and the empty circles indicate negative (-) thermocouple leads when viewed from the vacuum side.

TECHNICAL REFERENCE

High-Voltage Plug Attachment

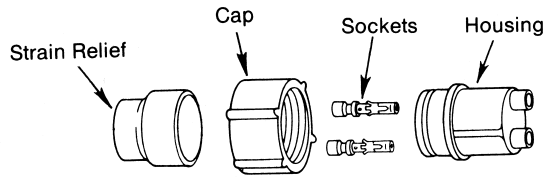

NOTE: Applies to 2, 4 and 7 pin high-voltage connectors.

Use Corona-Resistant High-Voltage Wire
 15KV Rating
 AWG #16 Max. Conductor
 .20 Max. Wire Insulation Diameter

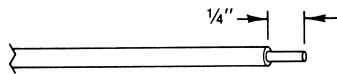

STEP 1 . . . Strip insulation back 1/4" from the end of all cables and pre-tin the conductor.

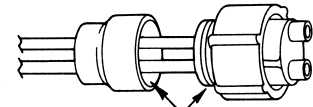

Apply cement at these locations

STEP 4 . . . Insert cable/socket assemblies in cavities of the housing until they lock into place, and moisture cure the "RTV-108" at 100% humidity and 140°F for 1 hour. This will seal cavities before final potting. Slip cap over housing and cement strain relief to the housing.

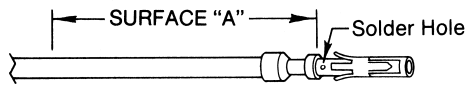

STEP 2 . . . Apply socket to the conductor by pushing it up against the insulation and solder onto the conductor. Clean SURFACE "A" (2 inches minimum) thoroughly with alcohol and apply a thin coating of "RTV-108" or equivalent.

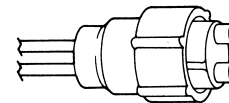

STEP 5 . . . Once the strain relief is attached, pot the strain relief and housing with Hysol #4215 or equivalent by pouring through the strain relief. (Potting mixture to be 100 parts of Hysol #4215 to 15 parts Hardener #3561.)

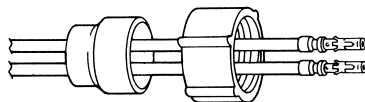

STEP 3 . . . Clean the inner surfaces of the housing and strain relief thoroughly with alcohol. Slide the strain relief and the cap over cables.

Thermocouple Plug Attachment

SPADE TYPE

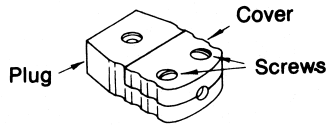

ANSI Type	Thermocouple Materials	Plug or Dot Color
K	Chromel /Alumel	Yellow
J	Iron/Constantan	Black
C†	Tungsten 5% Re/Tungsten 26% Re	Red
E	Chromel /Constantan	Violet
N†	Nicrosil/Nisil	Orange

† Not an ANSI symbol.

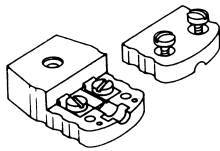

STEP 1 . . . Loosen the two screws in the cover and lift cover off plug.

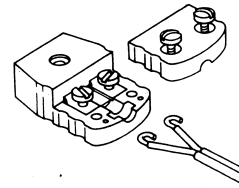

STEP 3 . . . Curve conductors clockwise as shown. Unscrew inner screws roughly 2-1/2 turns to allow the conductors to be fastened under the screw heads.

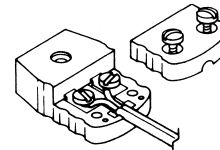

STEP 4 . . . Hook the conductors under the heads of the screws and tighten screws moderately.

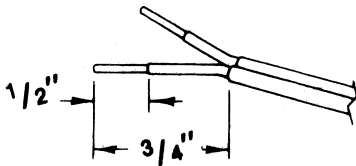

STEP 2 . . . Strip end of thermocouple wire to the dimensions shown.

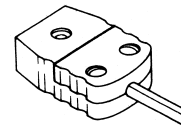

STEP 5 . . . Place cover back on the plug and tighten cover screws gently, being careful not to strip the threads in the cover.

TECHNICAL REFERENCE

Coaxial Cable/Plug Attachment

MICRODOT

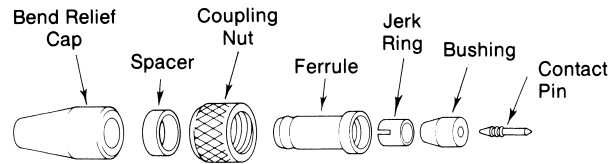

Coaxial Cable RG-196/U

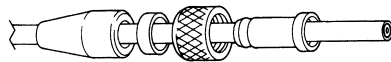

STEP 1 . . . Slide bend relief cap, spacer, coupling nut and ferrule over cable.

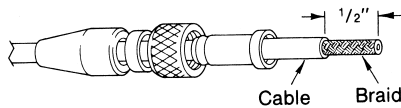

STEP 2 . . . Strip cable to the dimension shown.

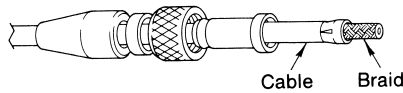

STEP 3 . . . Place jerk ring over shield, slotted end of ring should butt against cable jacket. Squeeze the ring snugly around the shield with a slight taper at the slotted end. Be careful not to squeeze the ring out of round.

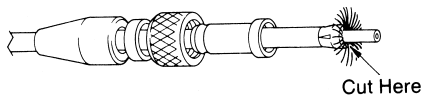

STEP 4 . . . Comb out braid and cut it close to the jerk ring as shown.

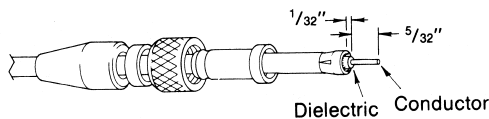

STEP 5 . . . Strip dielectric from end of conductor $5/32''$ and to $1/32''$ from the jerk ring (be careful not to nick conductor). If conductor is stranded it must be tinned.

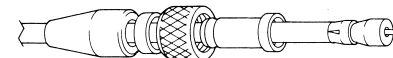

STEP 6 . . . Slip bushing over conductor and dielectric until bushing is against braid.

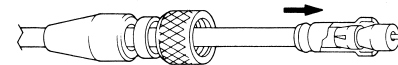

STEP 7 . . . Hold ferrule in one hand. With other hand push on the bushing until jerk ring and part of bushing start inside the ferrule.

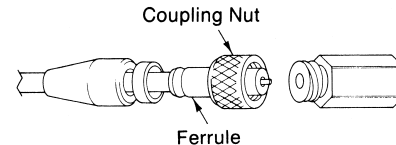

STEP 8 . . . Slide coupling nut over ferrule. Then screw coupling nut to Malco Tool, Part II.

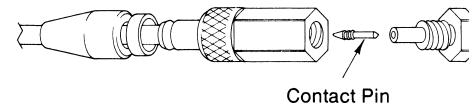

STEP 9 . . . Insert contact pin barbed end out, in small hole at the end of Malco Tool, Part 1, and screw into Part II as far as possible, thus forcing contact pin completely into bushing.



STEP 10 . . . Slide the bend relief cap up and over the end of the ferrule until it snaps into the groove. Remove Malco Tools, Part I and Part II.

Coaxial Cable/Plug Attachment

SMB



<p>STEP 1 . . . Dilate boot with Dilator (boot will remain dilated for approximately five minutes.) Slip boot over cable. When the optional black heat shrink tubing is used, activate with hot air gun after connector assembly. Trim outer jacket to indicated dimension.</p>	<p>STEP 4 . . . Slip cable assembly into body and trim excess braid.</p>
<p>STEP 2 . . . Slip sleeve over braid and against cable jacket. Fold braid back over sleeve and comb out braid to avoid bunching. Trim dielectric as indicated. Remaining dimension should be as shown; trim if necessary. Tin center conductor and remove excess solder.</p>	<p>STEP 5 . . . Crimp securely using Crimp Tool making sure that the contact does not protrude beyond insulator surface.</p>
<p>STEP 3 . . . Solder contact to inner conductor. Avoid excessive solder to permit insertion of contact into insulator. Avoid overheating, which could cause deformation of core. Contact must butt cable dielectric at point "x" to prevent contact from protruding beyond insulator surface.</p>	<p>STEP 6 . . . Slip boot over body as shown and use heat gun if required.</p>

SMA

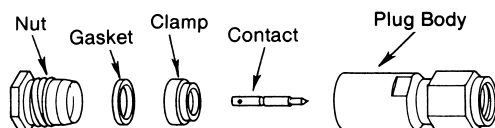

<p>STEP 1 . . . Place nut and gasket over cable and cut jacket to dimension shown.</p>	<p>STEP 4 . . . Trim dielectric 1/8" from the end of the cable. Do not nick center conductor.</p>
<p>STEP 2 . . . Comb out braid and taper forward toward the conductor.</p>	<p>STEP 5 . . . Solder contact in place so as to be seated squarely against dielectric. Clean all surfaces thoroughly.</p>
<p>STEP 3 . . . Place clamp over braid and push back against jacket. Fold braid back against clamp and trim as necessary so that wires do not touch shoulder of clamp.</p>	<p>STEP 6 . . . Thread connector assembly onto prepared cable assembly. Tighten to 20-25 in./lbs. torque.</p>

TECHNICAL REFERENCE

Coaxial Cable/Plug Attachment

BNC

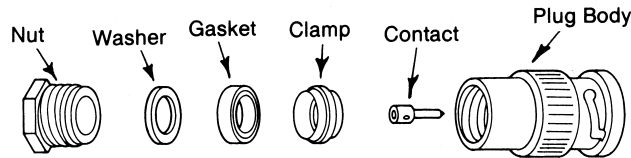

Coaxial Cables
 RG-58/U
 RG-140/U
 RG-141/U

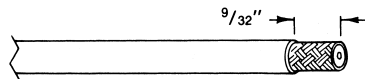

STEP 1 . . . Cut jacket and strip to dimension shown.

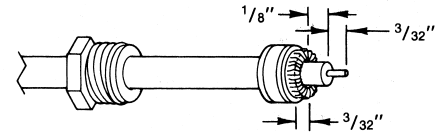

STEP 4 . . . With the clamp in place, fold back braid as shown and trim $3/32$ " from the end. Trim dielectric to the dimensions shown.

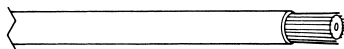

STEP 2 . . . Comb out braid and taper toward the center.

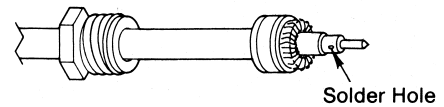

STEP 5 . . . Slip contact in place so it butts against the dielectric and solder in place. Remove excess solder from outside of contact. Be sure cable dielectric is not heated excessively and swollen so as to prevent dielectric from entering into connector body.

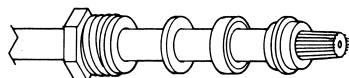

STEP 3 . . . Place the nut, washer, and gasket over the cable, then slide the clamp on over the braid so that the inner shoulder fits against the end of the cable jacket.

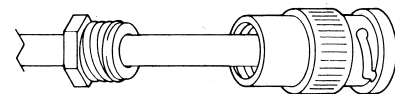

STEP 6 . . . Push assembly into body as far as it will go. Slide nut into body and screw in place with wrench until tight. For this operation, hold cable and shell rigidly and rotate nut.

TECHNICAL REFERENCE

Coaxial Cable/Plug Attachment

MHV

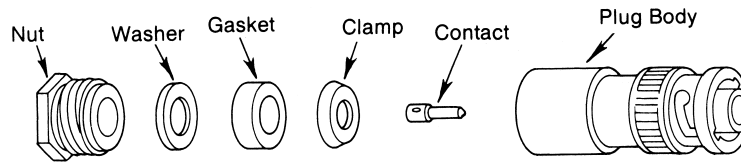

**Coaxial Cable
RG-59/U**

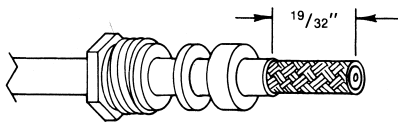

STEP 1 . . . Slide nut, washer and gasket over jacket, and cut off jacket 19/32" from end of cable as shown.

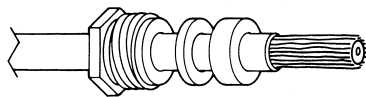

STEP 2 . . . Comb out braid, pull braid wires forward and taper toward conductor.

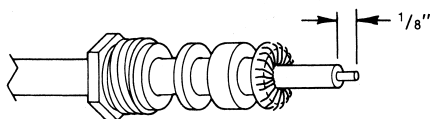

STEP 3 . . . Place clamp over braid and push back against cable jacket. Fold back braid wires as shown, trim to proper length and evenly form over clamp as shown. Cut dielectric to 1/8" dimension as shown. Tin exposed conductor using minimum amount of heat.

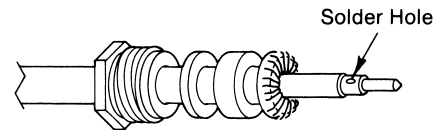

STEP 4 . . . Solder contact to conductor. Remove excess flux and solder from outside of contact.

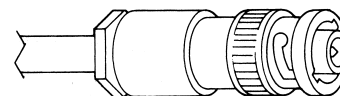

STEP 5 . . . Insert prepared cable termination into plug body. Tighten nut moderately, holding plug body stationary.

TECHNICAL REFERENCE

Coaxial Cable/Plug Attachment

SHV 5 KV

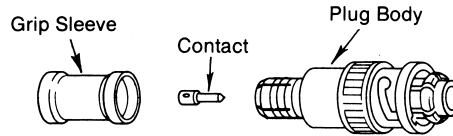

Coaxial Cable RG-59/U

STEP 1 . . . Slide the grip sleeve over the cable. Trim the end of the cable to the dimensions shown.

STEP 3 . . . Push the assembled contact into the plug body until the dielectric bottoms against the shoulder within the plug body. At this point, the body grip fingers should be under the flared braid as shown.

STEP 2 . . . Tin end of the cable and inside of contact. Solder the contact to the center conductor. Flare out the braid without fraying.

STEP 4 . . . Slide the grip sleeve forward against the plug body, over the braid and crimp as shown. Use Kings Hand Crimp Tool #KTH-1000 and Crimp Die #KTH-2062.

SHV 10 & 20KV

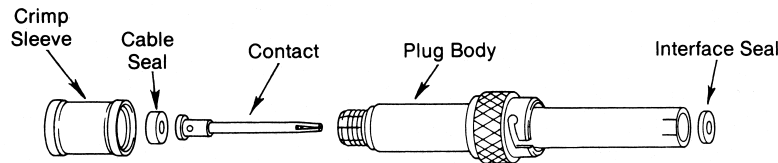

NOTE: Before assembly be sure you can distinguish between the cable seal and the interface seal. The cable seal has a .09" hole and is .10" thick. However, the interface seal has a .13" hole and is .07" thick. Do not interchange.

PART	Cable	A	B	C
10 KV	RG 58C/U	15/16	1 1/8	15/64
20 KV	RG-213/U	1 3/4	1 15/16	5/16

STEP 1 . . . Slide the crimp sleeve over the cable. Trim the end of the cable to the dimensions shown and tin the exposed conductor.

STEP 3 . . . Flare out braid without fraying the ends. Insert prepared cable assembly into the plug body carefully. DO NOT pinch or otherwise damage cable seal. Guide braid smoothly over the splined crimp area of the body until the contact shoulder butts against the inner insulator.

STEP 2 . . . Slip cable seal over center conductor then slide contact over conductor. Push contact against cable seal and maintain this slight pressure while soldering contact in place through solder hole.

STEP 4 . . . Slide the grip sleeve into position and crimp as shown. Use Ceramaseal's Crimping Tool #2840-02 or Thomas and Betts Crimping Tool #WT-540 with Crimping Die #5452. Make sure braid does not extend beyond the end of the grip sleeve. Insert interface seal into the open end of the plug. Carefully slide the interface seal over contact until it bottoms evenly around the contact.

TECHNICAL REFERENCE

Coaxial Cable/Plug Attachment

BSHV 7.5 KV

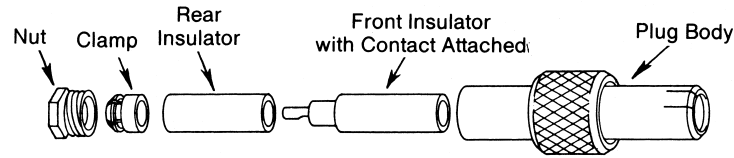

**Coaxial Cable
RG-59/U**

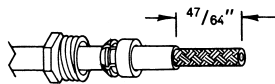

STEP 1 . . . Slide nut and clamp over cable. Cut the jacket to the dimension shown. Do not nick braid.

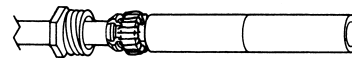

STEP 2 . . . Comb out braid and fold back against jacket. Cut dielectric to the dimension shown. Do not nick the conductor.

STEP 4 . . . Carefully slide the rear insulator up against the front insulator as shown. Fold braid out and slide clamp up to meet the braid. Fold the braid back over the clamp and trim so as to fit around the clamp as shown.

**Crimp Tool KTH-1000 & Die
(KTH 2001 or 2002)**

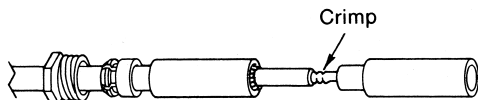

STEP 3 . . . Carefully slide rear insulator over cable just so it covers the braid. Insert the conductor into the crimp end of the front insulator and crimp as shown.

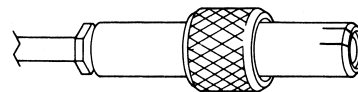

STEP 5 . . . Slide prepared cable end into plug body and tighten nut moderately.

TECHNICAL REFERENCE

Coaxial Cable/Plug Attachment

TYPE N

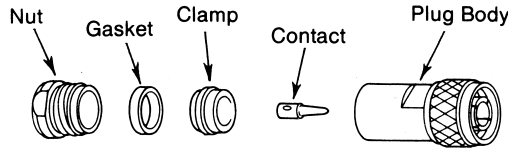

Coaxial Cable
 RG-8/U
 RG-9/U
 RG-213/U
 RG-214/U
 RG-225/U

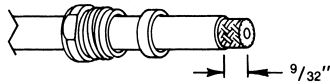

STEP 1 . . . Place nut and gasket with "V" groove toward clamp over cable and cut jacket to the dimension shown.

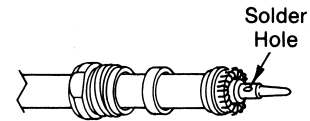

STEP 4 . . . Fold back braid as shown, trim to proper length and form over clamp as shown. Solder contact to center conductor.

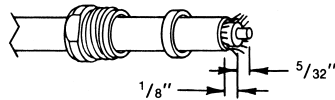

STEP 2 . . . Comb out braid and fold out. Cut off cable dielectric to the dimensions shown.

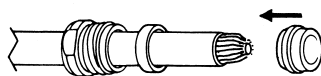

STEP 3 . . . Pull braid wires forward and taper toward conductor. Place clamp over braid so that the inner shoulder fits against the end of the cable jacket.

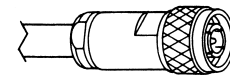

STEP 5 . . . Insert cable and parts into connector body. Make sure sharp edge of clamp seats properly in gasket. Tighten nut.

TECHNICAL REFERENCE

Coaxial Cable/Plug Attachment

HN

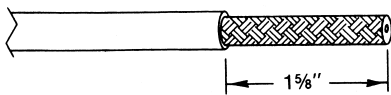
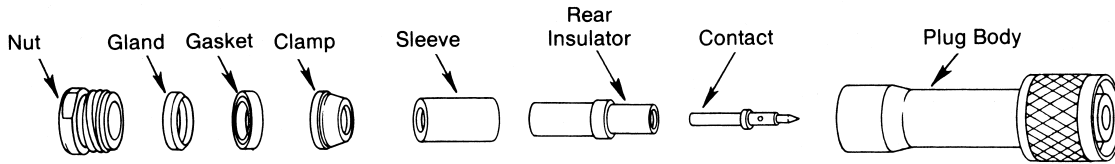

STEP 1 . . . Cut end of cable even. Strip off vinyl jacket to the dimension shown.

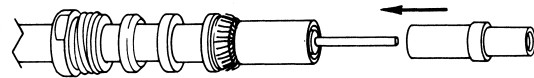

STEP 4 . . . Fold braid back over clamp and trim. Tin exposed center conductor using minimum amount of heat. Slide sleeve and rear insulator over cable dielectric.

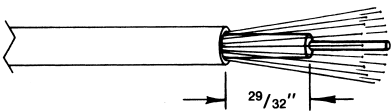

STEP 2 . . . Comb out braid and cut dielectric to the dimension shown.

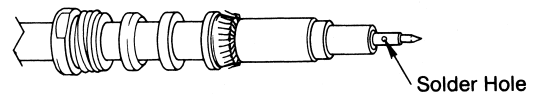

STEP 5 . . . Solder contact to center conductor. Rear insulator must seat against cable dielectric and contact shoulder must be flush with insulator face as shown. Coat cable dielectric and insulator mating surfaces with Amphenol #53-307 Silicone Compound or equal to achieve 5KV peak rating under operating conditions.

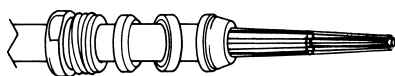

STEP 3 . . . Taper braid wires forward and slide nut and gland onto jacket. Make certain knife edge of gland is toward end of cable. Then slide gasket onto jacket with "V" groove toward gland. Clamp is now pushed over braid so that the internal shoulder butts flush against the cable jacket.

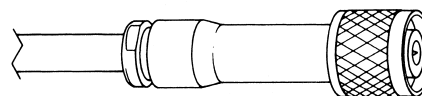

STEP 6 . . . Slide prepared cable terminations carefully into body. Be sure knife edge of gland remains in groove of gasket. Tighten nut with wrench, holding body stationary. Gasket should be cut in half during tightening.

TECHNICAL REFERENCE

Cable Terminations

Termination A - Coaxial

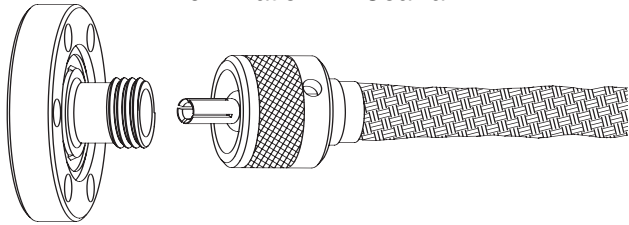

Termination B - Contact

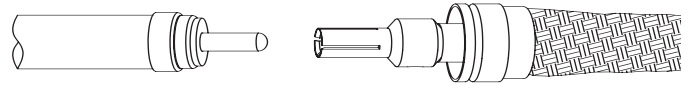

Termination C - In-Line

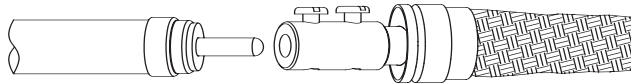

Termination D - Cable Splice

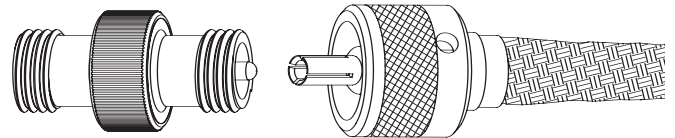

Termination E - BNC

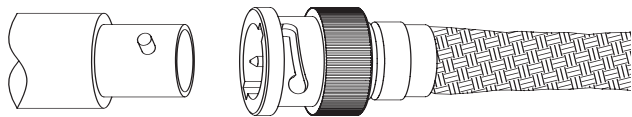

Termination F - MHV

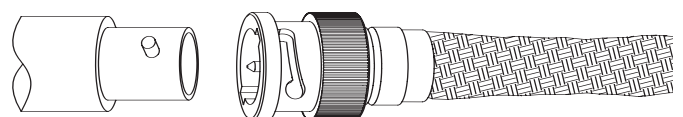

Termination G - Bare Conductor

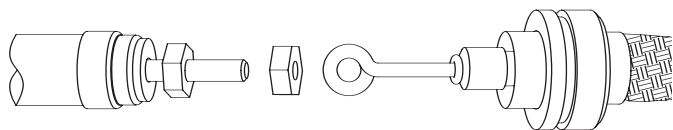

Termination H - Lug

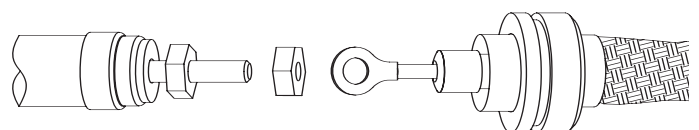

TECHNICAL REFERENCE

When choosing the best installation for your system, there are a number of considerations, including pressure, temperature and maintenance requirements of your system.

Pressure:

ConFlat flanges are recommended for low pressure applications. Because a ConFlat flange uses an OFE copper gasket, the outgassing range is very low. To reach very low pressures, the system hardware will probably have to be baked out.

Temperature:

ConFlat flanges can be baked to 450°C, while ISO-NW flanges may be baked to 205°C if Viton o-rings are used.

Maintenance:

Consider how often your system will require maintenance, since ConFlat flanges are more difficult to assemble and disassemble and require tools. ISO-NW flanges are easy to assemble and disassemble and require no tools.

INSTALLATION

Products in this catalog have been categorized by method of installation. Options include braze, solder, weld, NPT threaded, ConFlat flange, baseplate, and ISO-NW flange.

Braze:

Brazing is compatible for products that have mounting hardware made of nickel, copper-nickel, nickel-iron, Kovar, or stainless steel and that have been manufactured using higher temperature braze alloys. These items are identified in the tables throughout this catalog. Maximum braze temperature should not exceed 500°C without prior factory approval. Acceptable mounting configurations can be found on page L23.

Solder:

Soldering is acceptable for products that have mounting hardware made of copper, copper-nickel, nickel-iron or Kovar. Acceptable mounting configurations can be found on page L23.

Weld:

Products in this catalog identified for welding utilize Kovar, 52% nickel-iron, or stainless steel mounting hardware. Pulse-TIG, TIG, laser, or E-Beam welding are acceptable. It is important to minimize the heat concentration at seal areas to avoid thermal shock to the insulator. A number of suggested configurations can be found on page L23.

NPT Threaded:

NPT fittings provide reliable leak-free performance down to 10⁻⁶ torr. Use of Teflon sealing tape is recommended. Bakeouts are limited to 232°C. Refer to page L26.

ConFlat Flange:

ConFlat flanges are recommended for ultra-high-vacuum applications. They can be used either with a copper gasket for ConFlat to ConFlat mounting or with an o-ring for ConFlat to plate mounting. ConFlat mountings using the copper gasket can be baked to 450°C with very low outgassing. O-ring applications are limited in vacuum capability by the bakeout limitations of the o-ring. Viton o-ring applications can be baked to 205°C. See pages L24 - L25.

ISO-NW Flange:

ISO-NW flanges are recommended for vacuum applications down to 10⁻⁹ torr. Bakeout to 150°C is required to achieve this vacuum level. The advantage of using the ISO-NW flange mounting option is that installation and removal are quickly and easily accomplished. No tools are required. See page L26.

Baseplate:

Baseplate o-ring seals provide a quick and easy assembly to plates or housings for high-vacuum applications. Baseplates utilize a Viton o-ring and can be baked to 205°C. See page L26.

BRAZE/SOLDER

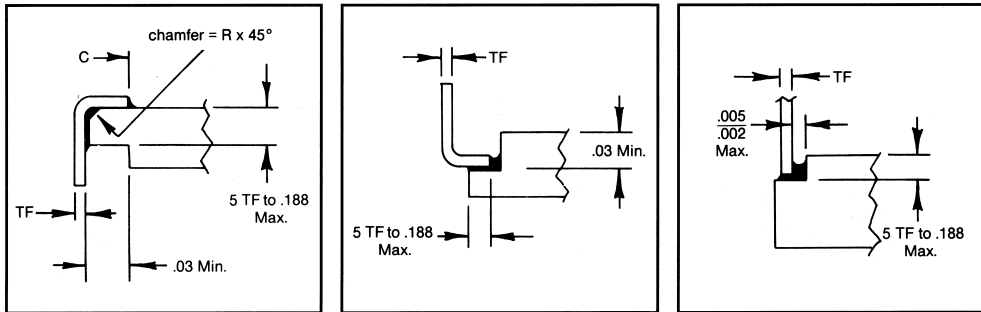

TF = Flange Thickness — Units with copper, copper nickel, nickel iron and Kovar can be soldered.
 C = Flange-Flat Diameter — Units with nickel, copper-nickel, nickel-iron, Kovar and stainless steel can be brazed.
 — Fit up to be at solder or braze temperature. Refer to thermal expansion curves on pages L4.

WELD

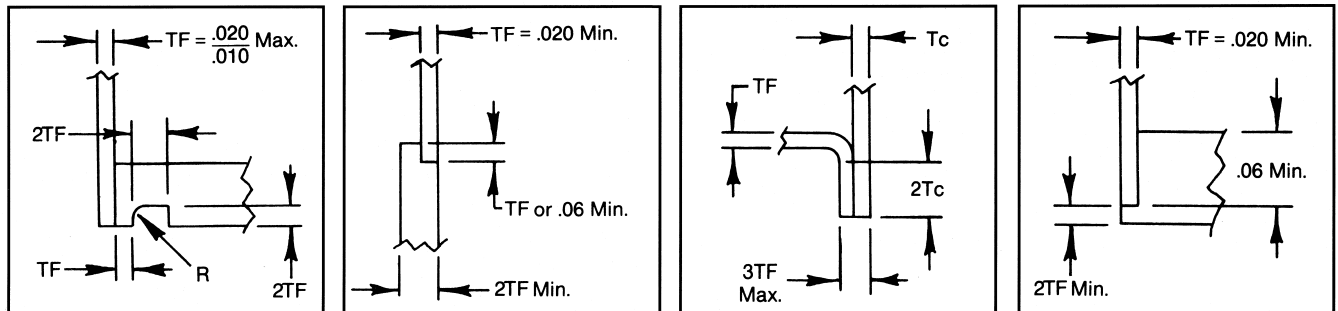

TF = Flange Thickness R = TF Tc = Mating Part Thickness

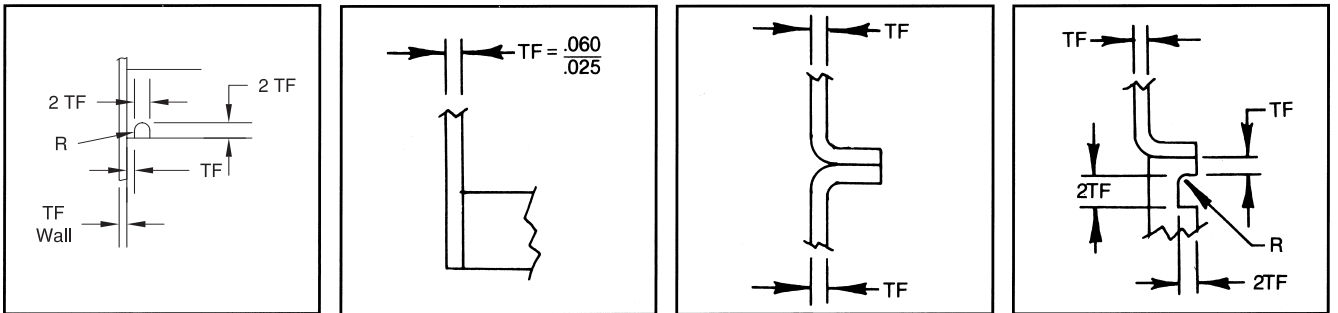

When welding components, the weld should be made on the vacuum side of the system to prevent virtual leaks from small spaces or gaps where the components mate. If both sides of the components need to be welded for strength, the vacuum side should be welded continuously and the welds on the outside of the system should be welded intermittently. All dimensions are in inches.

TECHNICAL REFERENCE

CONFLAT FLANGE

COPPER GASKET SEAL

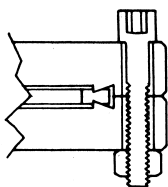
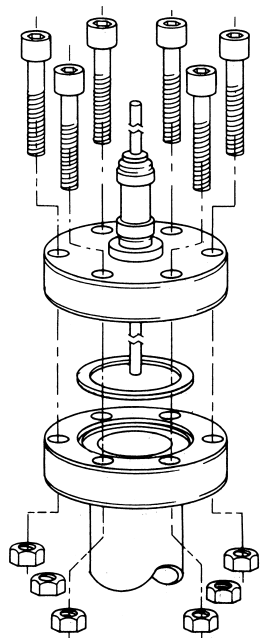

O-RING SEAL

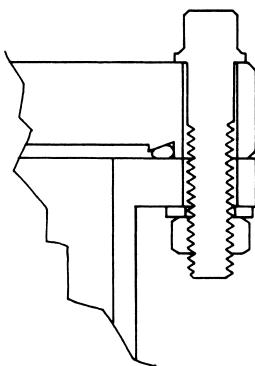
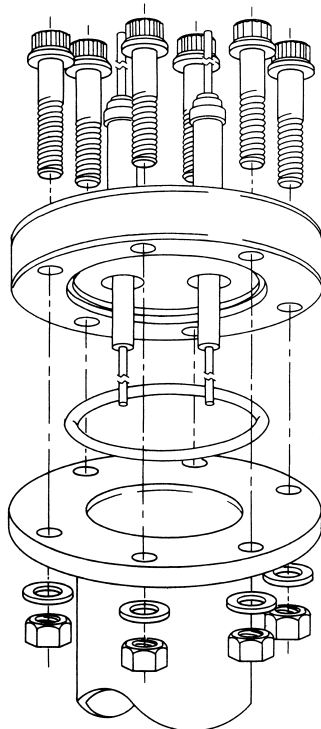

**Viton O-Ring Seal
Flange to Flange**

Flange Dia.	O-Ring Cross Section	Parker O-Ring Cat. No.
1.33	.103 Dia.	2-114
2.75	.139 Dia.	2-223
3.38	.139 Dia.	2-227
4.50	.139 Dia.	2-234
6.00	.139 Dia.	2-246
8.00	.139 Dia.	2-260
10.00	.139 Dia.	2-268

**Viton O-Ring Seal
Flange to Flat Plate**

Flange Dia.	O-Ring Cross Section	Parker O-Ring Cat. No.
1.33	.070 Dia.	2-17
2.75	.103 Dia.	2-130
3.38	.103 Dia.	2-139
4.50	.103 Dia.	2-151
6.00	.103 Dia.	2-157
8.00	.103 Dia.	2-165
10.00	.103 Dia.	2-173

Conflat Flange Assembly

- Finger-tighten all flange bolts, being certain they are evenly tightened.
- Torque the bolts using the torque pattern shown in the figure on page L25 in incremental steps with the final setting being the value listed in the table.

TECHNICAL REFERENCE

CONFLAT FLANGE: TIGHTENING SEQUENCE & BOLT HOLE LAYOUT

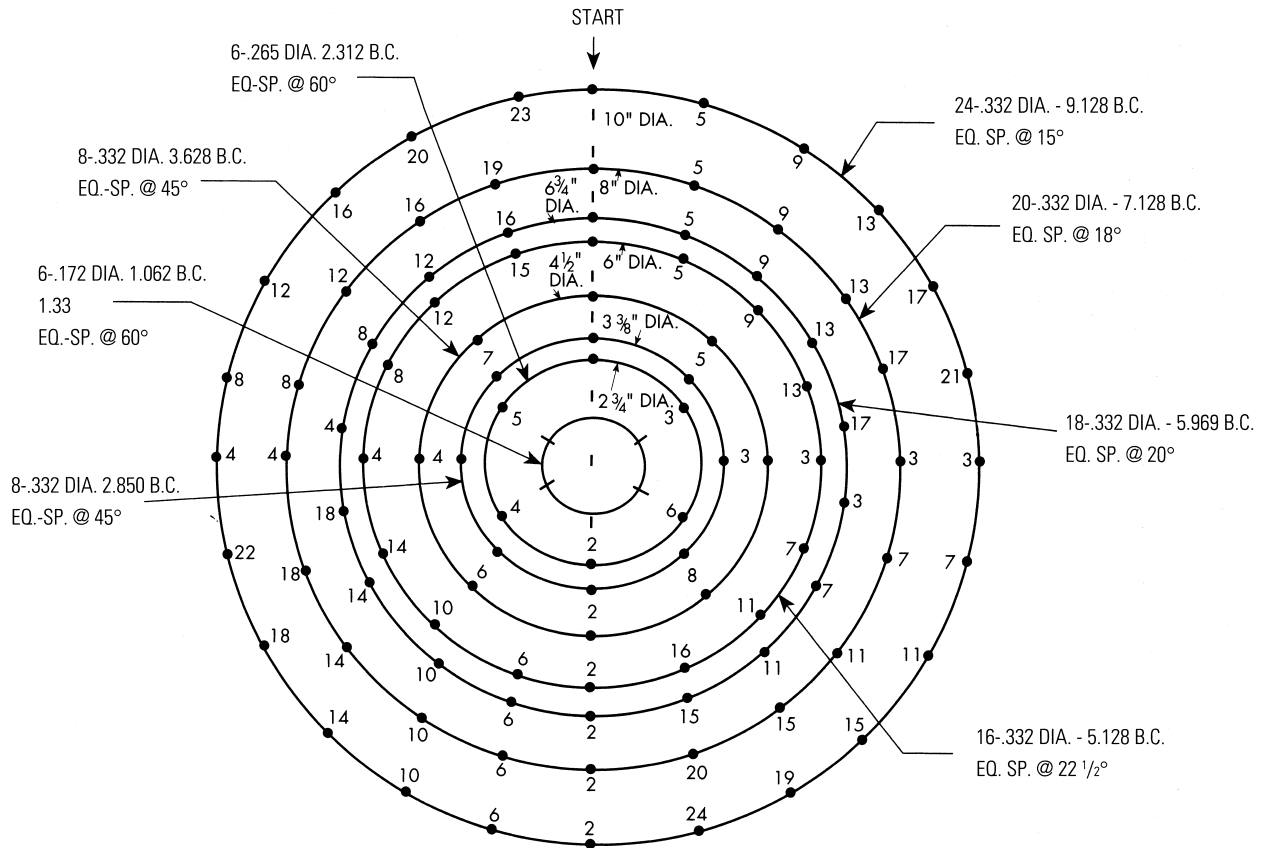

Schematic of bolt-hole locations, 1.33 in., 2-3/4 in., 3-3/8 in., 4-1/2 in., 6 in., 6-3/4 in., 8 in., 10 in. ultra-high-vacuum bakeable flanges numbered in sequence for completing seal.

Flange Bolt and Torque Data

Lubricated Bolt Torque	Bolt dia/thd	Flange Size (OD in.) and Number of Bolts						
		2 3/4	3 3/8	4 1/2	6	6 3/4	8	10
80 in.-lb (7 ft.-lb.) to 100 in.-lb max	1/4 in. -20	6	—	—	—	—	—	—
120 in.-lb (10 ft.-lb.) to 150 in.-lb max	5/16 in. -18	—	8	8	16	18	20	24

TECHNICAL REFERENCE

ISO NW FLANGE

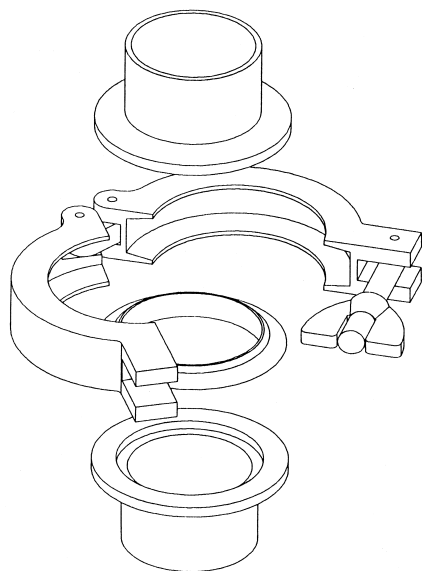

ISO-NW Flange Assembly

- Assemble the two flanges together with a clean O-ring and retainer between them. Place the mounted device in the proper orientation. Use of vacuum grease should not be required.
- Place the clamp around the flanges, positioning the clamp bolt and nut in an accessible position for tightening.
- Tighten down the nut. Hand tighten only. Do not use a wrench or pliers.

NPT THREAD

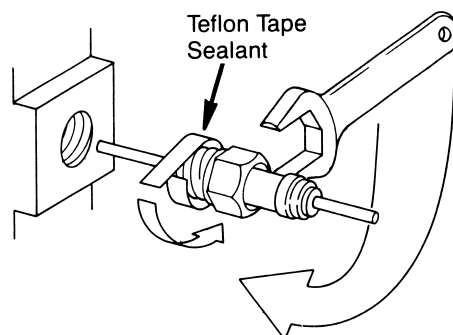

Use of threaded connections in a vacuum system should be minimized. The small spaces between the threads will cause virtual leaks. If threaded connection must be used, one of the connections should be slotted to permit rapid pumping of the threads and blind hole, if any.

BASEPLATE

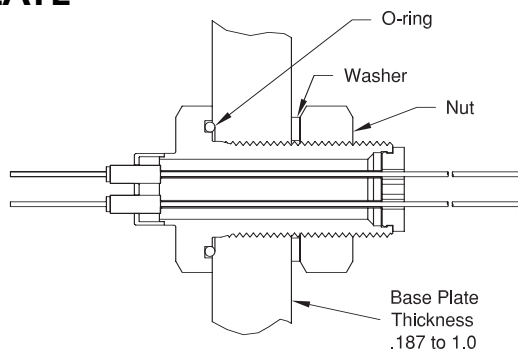

Install feedthrough with o-ring on vacuum or pressure side of the wall. Place washer and nut on air side of system. Tighten nut to compress o-ring.

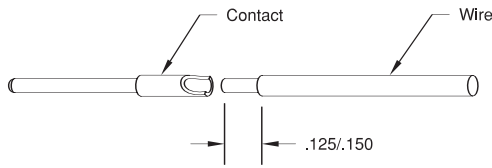

Solder Cup Contacts

Strip conductor to dimension shown. Tin the conductor. Place a small length of solder in the contact well. Insert tinned wire end into contact. Heat contact to melt solder and position the conductor.

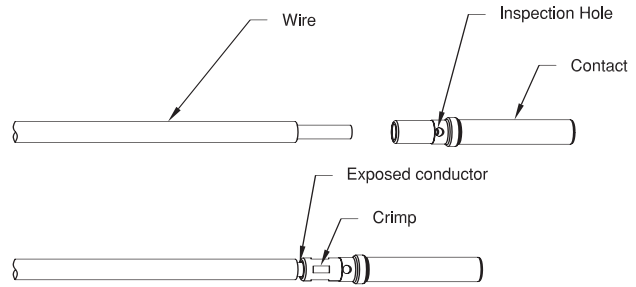

Crimp Contacts

Strip conductor to allow insertion of contact and a .010 to .030 maximum exposure between contact and wire insulation. Insert wire fully into contact, wire should be visible in inspection hole. Center crimp between end of contact and inspection hole. Refer to Chart on page K18 for crimp locator part number.

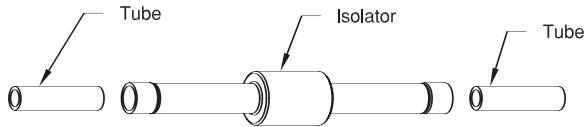

Water Isolators

Solder or Braze tube into isolator tube ends.

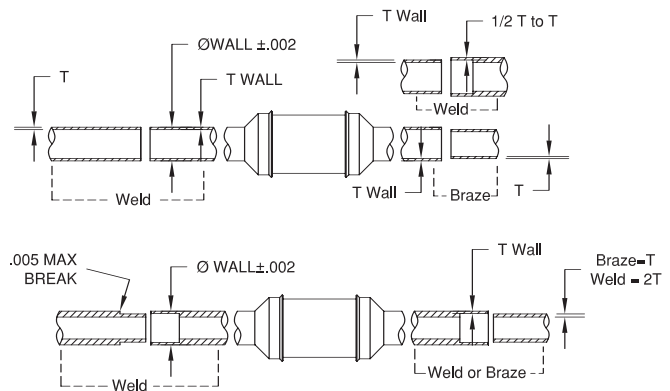

Isolators

Braze or Weld tube into isolator tube ends.

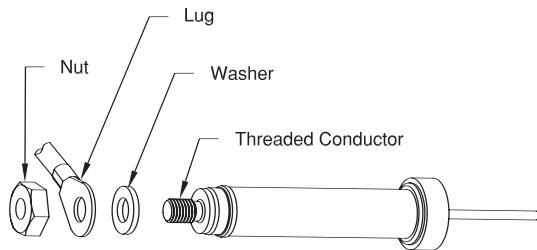

Threaded Conductor Feedthrough

Place washer on stud to limit torque on feedthrough. Put conductor termination over stud. Thread nut onto conductor to apply clamping force to termination.

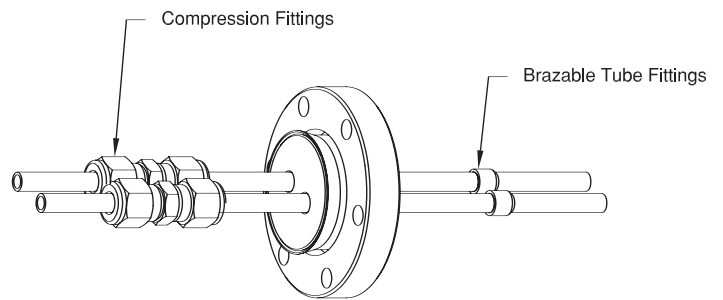

RF Feedthrough Installation

A variety of options can be used to attach to the tube/conductor depending on whether or not the joint or required components will couple with the RF field. Ceramaseal can make no general recommendation because of the large variety of systems and applications in various industries. Testing is recommended. Options include: vacuum brazing, soldering, compression fittings, and welding. Ceramaseal can offer designs with a short copper rod welded on the vacuum or air side of a tube to serve as a plug for those who do not need or want coolant fluid and want to attach with a clamp. Ceramaseal can also braze entire coils in a feedthrough and offer non-coil designs with return coolant paths.