



VEHICLES



AEROSPACE



GEARS & BEARINGS



ENGINEERING



WIND ENERGY

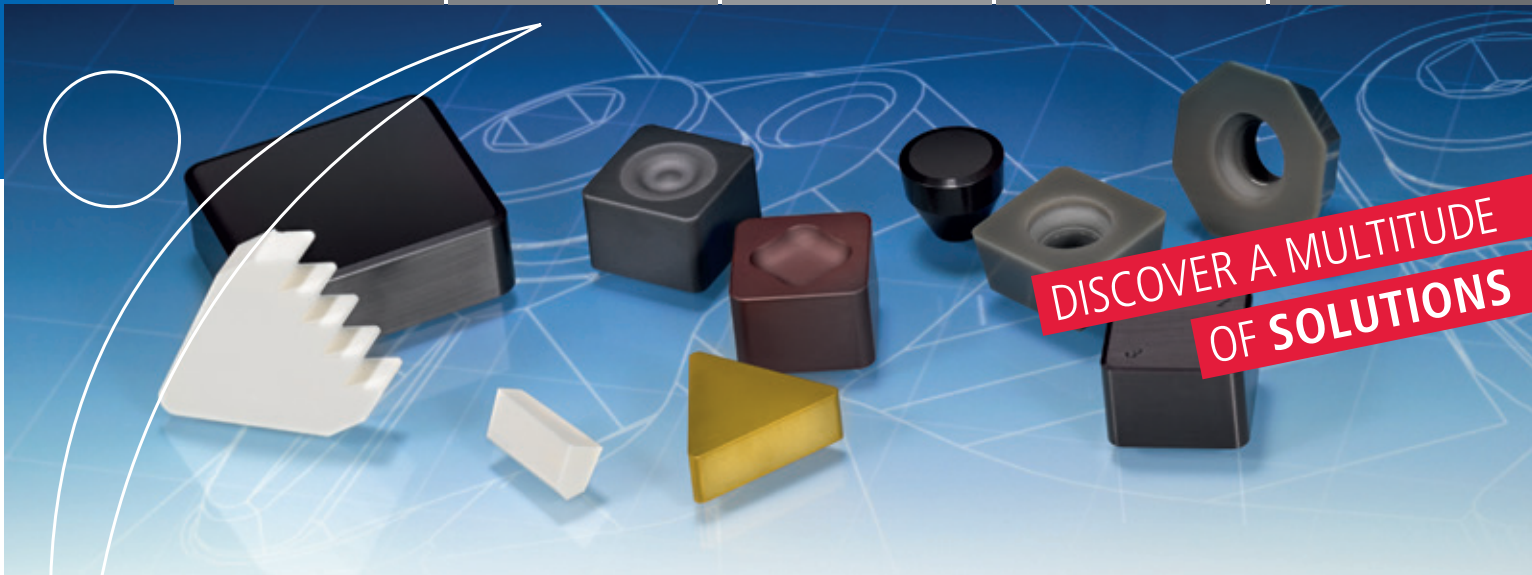

CERAMIC INSERTS

For Turning, Grooving and Milling

DISCOVER A MULTITUDE OF SOLUTIONS

AEROSPACE

The aerospace industry places extremely high demands on machining. In this field, machining capacity and process safety are the decisive parameters, and our CSA cutting materials together with our Monsoon Tool Technology tools are the optimal solution. Component examples: Jet engine components such as blisks.



AUTOMOTIVE INDUSTRY

For over 50 years, precision tools from CeramTec have been an integral part of highly productive machining solutions for components from the automotive industry. With our tool solutions, the implementation of concrete cost savings and increased productivity is always top priority. Component examples: Brake discs, gear components, fly wheels, clutch plates, brake components, drive shafts, hydraulic elements, engine/motor components.



MACHINERY AND PLANT ENGINEERING

Manufacturing complex components made of different materials with extreme precision and optimal surface quality in an economic way – that is the basic structure of requirements for which we work together with our customers to create innovative, cost-efficient machining solutions. Component examples: gearbox housings, flanges, guides, shafts, rollers.

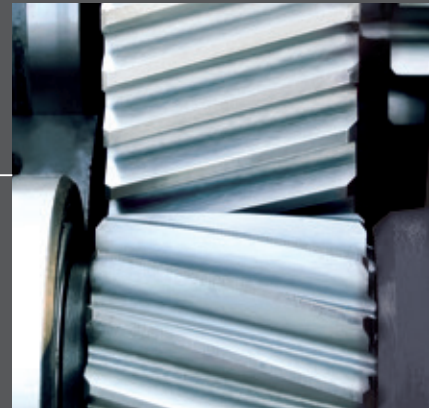

WIND ENERGY

In the field of wind energy, special machining solutions are often required because the components involved are frequently very large. Strict tolerance requirements and a high level of surface quality place exceptional demands on the cutting materials and tool holders. By observing and analysing the determining factors for machining, we are able to provide our customers with extremely efficient and cost-effective machining solutions. Component examples: Rotor flanges, rotor blade connections, planetary gear holders, gearbox housings, gear components.

GEAR TECHNOLOGY, DRIVE TECHNOLOGY AND BEARING INDUSTRY

Surface quality, tolerances and the tool life of the cutting materials are the quality standards for hard machining. Our unique range of cutting materials made of PCBN and ceramics, together with our perfectly matched tools, set the bar in this industry. In practice, this results in highly efficient and cost-effective machining. Component examples: Gear wheels, shafts, large gearbox components, bearing rings and rolling elements.

VEHICLE MANUFACTURING INDUSTRY

MOTOR INDUSTRY

The high-performance materials that are used in this industry require cutting materials that ensure an extremely high level of process reliability and a consistently high quality level. Our cutting materials and tools are the perfect solution.

Component examples: Connecting rods, pulley wheels, cylinder heads, cylinder liners

TRANSPORT

When machining components for the transport industry, special solutions are often required in order for the machining process to remain economical and efficient. Our tools and cutting materials make these kinds of solutions possible.

Component examples: Wheel rims, shafts, bearings

AGRICULTURAL AND CONSTRUCTION MACHINERY

We offer highly efficient bearing solutions for components for agricultural and construction machinery. Our range of solutions are currently used for machining of soft steel as well as processing cast iron and hardened parts.

Component examples: Brake components, drive shafts, hydraulic elements, motor components

AUTOMOTIVE

For over 50 years, precision tools from CeramTec have been an integral part of highly productive machining solutions for components from the automotive industry.

Component examples: Brake discs, brake drums, fly wheels, connecting rods, gear components, engine blocks



Motor industry



Transport



Agricultural and construction machinery



Automotive

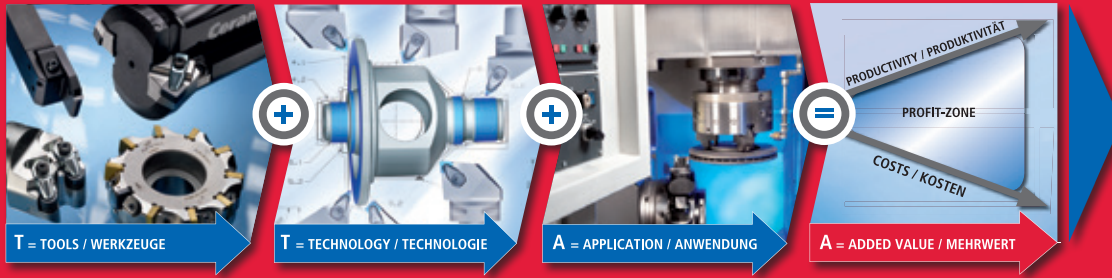



SPK Ceramic Cutting Materials	6
SPK Cutting Ceramics: Specifications and Application Table	7
SPK Ceramic Inserts for Turning	8
Cutting Data Recommendations for Turning	9 - 15
Designation System for Turning Inserts according to ISO 1832	16 - 17
Contents: Ceramic Inserts for Turning	18 - 19
SPK Ceramic Inserts for Turning	20 - 51
SPK Ceramic Inserts for Grooving	53
Cutting Data Recommendations for Grooving	54
Designation System for Grooving Inserts	56 - 57
Designation System for Grooving Inserts: Poly-V Profiles	58 - 59
Contents: Ceramic Inserts for Grooving	61
SPK Ceramic Inserts for Grooving	62 - 75
SPK Ceramic Inserts for Milling	77
Cutting Data Recommendations for Milling	78 - 79
Designation System for Milling Inserts	80 - 81
Contents: Ceramic Inserts for Milling	82
SPK Ceramic Inserts for Milling	83 - 91

OXIDE CERAMICS

The traditional ceramic cutting materials based on Al_2O_3 and ZrO_2 are used for grooving, rough turning and finishing grey cast iron and alloyed grey cast iron workpieces without coolant.

SN 60 The Al_2O_3 cutting material with the highest wear resistance and red hardness. Ideal for grooving and turning cast iron with continuous cut.

SN 80 E A standard cutting material for turning cast iron and alloyed cast iron with continuous cut, larger measurements and high standards for wear resistance.

SN 180 This cutting material offers maximum reliability for finish-turning and rough turning grey cast iron with continuous cut thanks to its improved thermal and wear resistance.

MIXED CERAMICS

Mixed ceramics are composite materials made of aluminium oxide and a titanium hardening component with excellent wear resistance and edge stability, even at high temperatures. Mixed ceramics are used in hard part turning of hardened steels, hard turning of rolls and fine machining of workpieces made of grey cast iron.

SH 2 has an extremely homogeneous submicron structure. This results in increased mechanical and thermal resistance and allows a highly precise design of the cutting edges. The mixed ceramic material for hard fine machining with continuous cut.

SH 4 This mixed ceramic material has a significantly increased wear resistance, as well as extreme toughness and high edge stability. The ideal cutting material for both roll machining and finishing grey cast iron and ductile cast iron with continuous or light interrupted cut.

SILICON NITRIDE AND SiAlON CERAMICS

Our cutting materials have to meet a wide variety of requirements, from those of basic rough turning to high-performance machining of difficult to machine cast iron materials with continuous or interrupted cut. Our broad range of cutting materials offers the optimal solution for numerous cutting applications.

SL 408 The basic cutting material for rough turning grey cast iron workpieces with continuous or interrupted cut.

SL 406 This basic type has a fine, homogeneous structure, making it ideal for semi-finishing grey cast iron components with continuous or interrupted cut.

SL 500 This standard silicon nitride ceramic grade offers advantages for a broad range of applications in roughing and finishing grey cast iron materials with continuous or interrupted cut.

SL 506 The finishing specialist for finish turning grey cast iron materials. Embedded hardening components give this material extremely high edge stability and wear resistance without sacrificing its toughness.

SL 508 This cutting material is designed especially for rough turning grey cast iron workpieces, particularly with an interrupted cut. It features maximum toughness with extreme hardness and good wear resistance.

SL 606 This cutting all-rounder can handle applications from finishing to light rough turning. It also offers high size accuracy.

SL 608 This roughing material is ideal for alloyed cast iron materials. It ensures a consistently high output, even under difficult conditions.

SL 808 The SL 808's optimised toughness and wear resistance deliver maximum cutting lengths when rough milling grey cast iron and ductile cast iron with highest feed rates per tooth.

SL 550 C The TiN- Al_2O_3 coating on this silicon nitride ceramic allows it to perform roughing and semi-finishing operations on ductile cast iron workpieces, even under difficult cutting conditions.

SL 554 C The multi-layer Ti-based coating offers increased wear resistance and reduces the friction forces between the material being machined and the cutting material. It is optimised for roughing high-strength ductile cast iron workpieces with an interrupted or smooth cut.

SL 654 C The multi-layer TiCN/TiN coating ensures optimum performance for rough turning fresh grey cast iron. It also allows the cutting data and, as a result, the machining volume to be increased considerably.

SL 658 C This high-end cutting material delivers its best performance during HPC machining of ductile cast iron workpieces. Its multi-layer Al_2O_3 coating allows maximum cutting speeds and large chip cross-section to optimise the cost-effectiveness and productivity of roughing operations.

SL 854 C The multi-layer TiN coating reduces wear and significantly decreases friction between the cutting material and the material being machined. As a result, it offers longer tool lives. This cutting material can be used for semi-finishing and finishing grey cast iron and ductile cast iron.

SL 858 C Maximum toughness and wear resistance make this TiN- Al_2O_3 -coated material ideal for milling in high-performance roughing and semi-finishing operations on grey cast iron and ductile cast iron components.

SPK Cutting Ceramics: Specifications and Application Table

	SPK type	ISO*	Material group			Machining technique			Area of application (DIN ISO 513)				
									01	10	20	30	40
Applications			P	K	H	T	M	G					
Mixed ceramic	SH 2	CM-K10	●	●	●	●	●	○					
	SH 4	CM-K10		●	●	●							
Oxide ceramic	SN 60	CA-K10		●		●		●					
	SN 80 E	CA-P20	○	●		●		●					
	SN 180	CA-K15		●		●							
Silicon nitride ceramic and SiAlON	SL 406	CN-K25		●		●							
	SL 408	CN-K30		●		●							
	SL 500	CN-K25		●		●	●	●					
	SL 506	CN-K20		●		●							
	SL 508	CN-K30		●		●							
	SL 606	CN-K25		●		●							
	SL 608	CN-K30		●		●		●					
	SL 808	CN-K30		●			●						
Coated	SL 550 C	CC-K25		●		●							
	SL 554 C	CC-K20		●		●							
	SL 654 C	CC-K25		●		●							
	SL 658 C	CC-K30		●		●							
	SL 854 C	CC-K20		●			●						
	SL 858 C	CC-K30		●			●						

*ISO: ISO application group

Material group:

P = steel

K = cast iron

H = hard materials

Machining technique:

T = turning

M = milling

G = grooving

← Main area of application
 ← Area of application

● Primary applications

○ Additional applications

SPK Ceramic Inserts for Turning

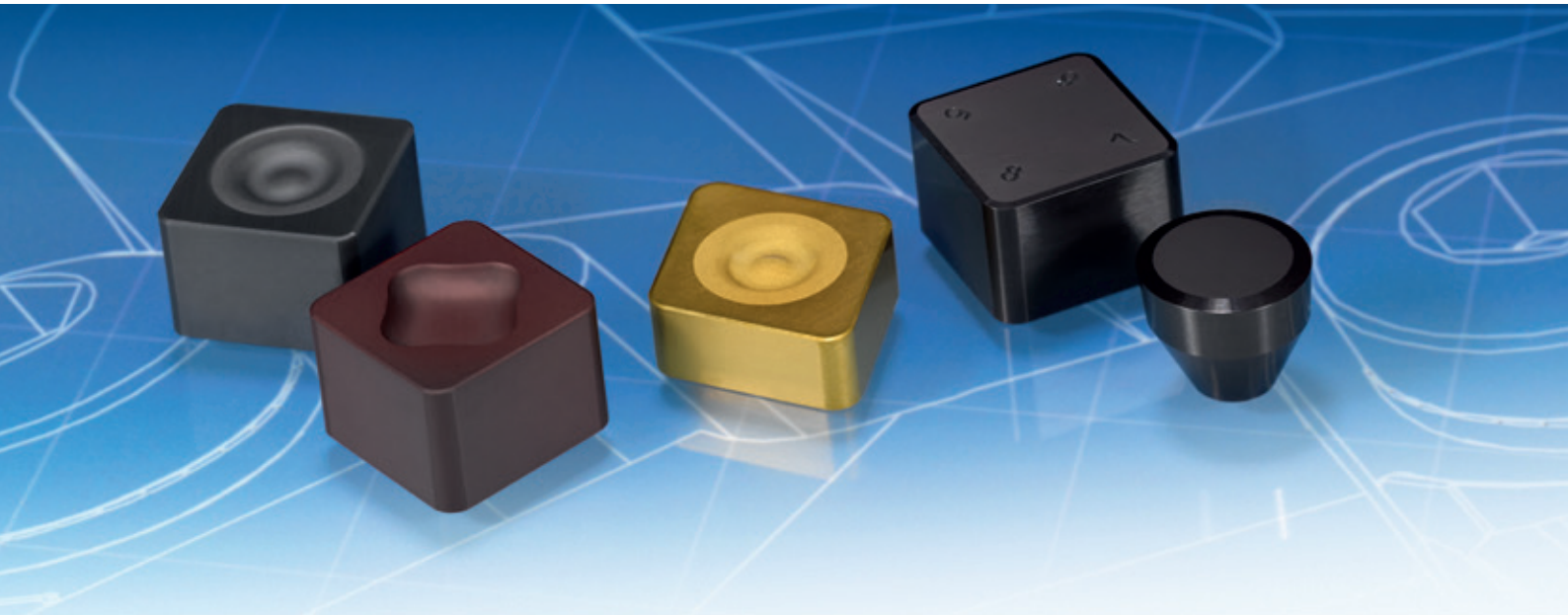

Cutting Data Recommendations for Turning Grey Cast Iron

MATERIAL NO.	HARDNESS (HB)	D	EU	F	GB	S	E	I	USA	J
		DIN	EN	AFNOR	B.S.	SS	UNE	UNI	AISI/SAE	JIS
0.6015	190	GG-15	GJL-150	Ft 15 D	Grade 150	0115-00	FG 15	G 15	No 25 B	FC 150
0.6020	210	GG-20	GJL-200	Ft 20 D	Grade 220	0120-00		G 20	No 30 B	FC 200
0.6025	240	GG-25	GJL-250	Ft 25 D	Grade 260	0125-00	FG 25	G 25	No 35 B	FC 250
0.6030	260	GG-30	GJL-300	Ft 30 D	Grade 300	0130-00	FG 30	G 30	No 45 B	FC 300
0.6035	280	GG-35	GJL-350	Ft 35 D	Grade 350	0135-00	FG 35	G 35	No 50 B	FC 350

SPK silicon nitride ceramic / SiAlON

HARDNESS (HB)	CUTTING SPEED v_c (m/min)		CUTTING DEPTH a_p (mm)	FEED RATE f (mm)		GRADE
	RECOMMENDED VALUE	OVERALL RANGE		RECOMMENDED VALUE	OVERALL RANGE	

∇^{25} Roughing with continuous cut

140 - 210	800	400 - 1200	1.0 - 4.0	0.40	0.20 - 0.60	SL 406
	800	400 - 1200	2.0 - 6.0	0.50	0.20 - 0.80	SL 408
	800	400 - 1000	1.0 - 5.0	0.40	0.15 - 0.60	SL 500
	900	500 - 1200	1.0 - 4.0	0.40	0.15 - 0.50	SL 506
	900	500 - 1200	2.0 - 6.0	0.50	0.15 - 0.90	SL 508
	1000	500 - 1200	2.0 - 4.0	0.40	0.15 - 0.60	SL 606
	900	500 - 1200	2.0 - 6.0	0.50	0.20 - 0.90	SL 608
	1000	500 - 1200	1.0 - 4.0	0.40	0.20 - 0.60	SL 654 C
	1000	500 - 1200	1.0 - 5.0	0.40	0.20 - 0.60	SL 554 C
220 - 240	800	400 - 1200	1.0 - 4.0	0.40	0.20 - 0.60	SL 406
	800	400 - 1200	2.0 - 6.0	0.50	0.20 - 0.80	SL 408
	800	400 - 1200	1.0 - 5.0	0.40	0.15 - 0.60	SL 500
	900	500 - 1200	1.0 - 4.0	0.40	0.15 - 0.50	SL 506
	900	500 - 1200	2.0 - 6.0	0.50	0.15 - 0.90	SL 508
	1000	500 - 1200	2.0 - 4.0	0.40	0.15 - 0.50	SL 606
	900	500 - 1200	2.0 - 6.0	0.50	0.20 - 0.90	SL 608
	1000	500 - 1200	1.0 - 4.0	0.40	0.20 - 0.60	SL 654 C
	900	500 - 1200	1.0 - 5.0	0.40	0.20 - 0.60	SL 554 C
250 - 280	700	400 - 1100	1.0 - 3.0	0.35	0.20 - 0.50	SL 406
	700	400 - 1100	2.0 - 4.0	0.40	0.20 - 0.70	SL 408
	700	400 - 900	1.0 - 4.0	0.30	0.15 - 0.60	SL 500
	800	500 - 1200	1.0 - 3.0	0.30	0.15 - 0.50	SL 506
	800	500 - 1200	2.0 - 5.0	0.40	0.15 - 0.80	SL 508
	900	500 - 1200	2.0 - 4.0	0.30	0.15 - 0.50	SL 606
	800	500 - 1200	2.0 - 5.0	0.50	0.20 - 0.80	SL 608
	900	500 - 1200	1.0 - 0.3	0.30	0.20 - 0.50	SL 654 C
	800	500 - 1100	2.0 - 4.0	0.30	0.20 - 0.60	SL 554 C

Cutting Data Recommendations for Turning Grey Cast Iron

HARDNESS (HB)	CUTTING SPEED v_c (m/min)		CUTTING DEPTH a_p (mm)	FEED RATE f (mm)		GRADE
	RECOMMENDED VALUE	OVERALL RANGE		RECOMMENDED VALUE	OVERALL RANGE	

$\sqrt[2.5]{}$ Roughing with an interrupted cut

140 - 210	800	400 - 1200	1.0 - 3.0	0.40	0.20 - 0.60	SL 406
	800	400 - 1200	2.0 - 4.0	0.50	0.20 - 0.90	SL 408
	800	400 - 1000	1.0 - 4.0	0.50	0.15 - 0.70	SL 500
	900	500 - 1200	2.0 - 5.0	0.50	0.15 - 1.00	SL 508
	900	500 - 1200	2.0 - 5.0	0.50	0.20 - 1.00	SL 608
	1000	500 - 1200	1.0 - 4.0	0.30	0.20 - 0.50	SL 554 C
220 - 240	800	400 - 1200	1.0 - 3.0	0.40	0.20 - 0.60	SL 406
	800	400 - 1200	2.0 - 4.0	0.50	0.20 - 0.90	SL 408
	800	400 - 1200	1.0 - 4.0	0.50	0.15 - 0.70	SL 500
	900	500 - 1200	2.0 - 5.0	0.50	0.15 - 1.00	SL 508
	900	500 - 1200	2.0 - 5.0	0.50	0.20 - 1.00	SL 608
	1000	500 - 1200	1.0 - 4.0	0.30	0.20 - 0.50	SL 554 C
250 - 280	700	400 - 1100	1.0 - 3.0	0.35	0.20 - 0.50	SL 406
	700	400 - 1100	2.0 - 3.0	0.40	0.20 - 0.70	SL 408
	800	400 - 900	1.0 - 3.0	0.40	0.15 - 0.60	SL 500
	800	500 - 1200	2.0 - 4.0	0.40	0.15 - 0.80	SL 508
	800	500 - 1200	2.0 - 4.0	0.40	0.20 - 0.80	SL 608
	800	500 - 1200	1.0 - 4.0	0.30	0.20 - 0.40	SL 554 C

$\sqrt[6.3]{}$ Finishing with continuous or interrupted cut

140 - 280	900	400 - 1200	0.5 - 1.5	0.25	0.20 - 0.50	SL 406
	800	400 - 1200	0.5 - 2.0	0.25	0.15 - 0.50	SL 500
	1000	500 - 1200	0.5 - 1.5	0.15	0.07 - 0.55	SL 506
	1000	500 - 1200	0.5 - 2.0	0.25	0.20 - 1.00	SL 606
	1000	600 - 1200	0.5 - 2.0	0.25	0.20 - 0.50	SL 554 C
	1000	600 - 1200	0.5 - 1.5	0.20	0.20 - 0.40	SL 654 C

Cutting Data Recommendations for Turning Grey Cast Iron

SPK oxide ceramic

HARDNESS (HB)	CUTTING SPEED v_c (m/min)		CUTTING DEPTH a_p (mm)	FEED RATE f (mm)		GRADE
	RECOMMENDED VALUE	OVERALL RANGE		RECOMMENDED VALUE	OVERALL RANGE	
25/ Roughing with continuous cut						
140 - 210	600	300 - 1000	1.0 - 4.0	0.30	0.20 - 0.50	SN 80 E
	800	400 - 1000	1.0 - 4.0	0.30	0.20 - 0.50	SN 180
220 - 240	500	200 - 800	1.0 - 4.0	0.30	0.20 - 0.50	SN 80 E
	600	400 - 800	1.0 - 4.0	0.30	0.20 - 0.50	SN 180
250 - 280	300	100 - 400	1.0 - 4.0	0.30	0.20 - 0.50	SN 80 E
	400	200 - 600	1.0 - 4.0	0.30	0.20 - 0.50	SN 180
6.3/ Finishing with continuous cut						
140 - 210	750	400 - 1200	0.2 - 1.0	0.20	0.15 - 0.40	SN 60
	600	400 - 1000	0.2 - 1.0	0.25	0.15 - 0.40	SN 180
220 - 240	550	300 - 800	0.2 - 1.0	0.20	0.15 - 0.40	SN 60
	400	300 - 600	0.2 - 1.0	0.25	0.15 - 0.40	SN 180
250 - 280	350	150 - 450	0.2 - 1.0	0.20	0.15 - 0.40	SN 60
	300	150 - 400	0.2 - 1.0	0.25	0.15 - 0.40	SN 180

SPK mixed ceramic

HARDNESS (HB)	CUTTING SPEED v_c (m/min)		CUTTING DEPTH a_p (mm)	FEED RATE f (mm)		GRADE
	RECOMMENDED VALUE	OVERALL RANGE		RECOMMENDED VALUE	OVERALL RANGE	
6.3/ Finishing						
140 - 210	800	400 - 1200	0.5 - 2.0	0.20	0.15 - 0.25	SH 2
	900	400 - 1200	0.5 - 2.0	0.20	0.15 - 0.25	SH 4
220 - 240	600	400 - 1200	0.5 - 2.0	0.20	0.15 - 0.25	SH 2
	800	400 - 1200	0.5 - 2.0	0.20	0.15 - 0.25	SH 4
250 - 280	400	400 - 1000	0.5 - 2.0	0.20	0.15 - 0.25	SH 2
	600	400 - 1000	0.5 - 2.0	0.20	0.15 - 0.25	SH 4
0.8/ Fine finishing						
140 - 240	550	300 - 650	0.1 - 1.0	0.1	0.10 - 0.20	SH 2
	650	300 - 650	0.1 - 1.0	0.1	0.10 - 0.20	SH 4
240 - 280	400	150 - 500	0.1 - 1.0	0.1	0.10 - 0.20	SH 2
	500	150 - 500	0.1 - 1.0	0.1	0.10 - 0.20	SH 4

Cutting Data Recommendations for Turning Ductile Cast Iron

MATERIAL NO.	UTS (N/mm ²)	(D)	(EU)	(F)	(GB)	(S)	(E)	(I)	(USA)	(J)
		DIN	EN	AFNOR	B.S.	SS	UNE	UNI	AISI/SAE	JIS
0.7040	400	GGG-40	GJL-400-15	FGS 400-12	SNG 420/12	0717-02	FGE 38-17	GS 370-17	60-40-18	FCD 400
0.7050	500	GGG-50	GJL-500-7	FGS 500-7	SNG 500/7	0727-02	FGE 50-7	GS 500-7	65-45-12	FCD 500
0.7060	600	GGG-60	GJL-600-3	FGS 600-3	SNG 600/3	0732-03	FGE 60-2	GS 600-2	80-55-06	FCD 600
0.7070	700	GGG-70	GJL-700-2	FGS 700-2	SNG 700/2	0737-01	FGE 70-2	GS 700-2	100-70-03	FCD 700

SPK silicon nitride ceramic/SiAlON

TENSILE STRENGTH UTS (N/mm ²)	CUTTING SPEED v_c (m/min)		CUTTING DEPTH a_p (mm)	FEED RATE f (mm)		GRADE
	RECOMMENDED VALUE	OVERALL RANGE		RECOMMENDED VALUE	OVERALL RANGE	
25 ∇ Roughing with continuous cut						
400 - 600	600	500 - 800	1.0 - 5.0	0.40	0.15 - 0.60	SL 550 C
	600	500 - 800	1.0 - 5.0	0.50	0.30 - 0.70	SL 658 C
700	500	400 - 700	1.0 - 5.0	0.40	0.15 - 0.60	SL 550 C
	600	400 - 700	1.0 - 5.0	0.50	0.30 - 0.70	SL 658 C
25 ∇ Roughing with an interrupted cut						
400 - 700	600	500 - 800	1.0 - 4.0	0.40	0.15 - 0.50	SL 550 C
	500	400 - 700	1.0 - 3.0	0.35	0.10 - 0.60	SL 554 C
	600	400 - 600	1.0 - 3.0	0.30	0.15 - 0.50	SL 654 C
	600	400 - 800	1.0 - 5.0	0.45	0.20 - 0.70	SL 658 C
12.5 ∇ Semi-finishing with continuous cut						
400 - 600	500	300 - 600	0.5 - 3.0	0.40	0.15 - 0.50	SL 550 C
	500	300 - 600	0.5 - 3.0	0.50	0.20 - 0.80	SL 658 C
700	500	300 - 600	0.5 - 3.0	0.35	0.15 - 0.60	SL 550 C
	500	300 - 600	0.5 - 3.0	0.40	0.20 - 0.80	SL 658 C
12.5 ∇ Semi-finishing with an interrupted cut						
400 - 700	500	400 - 600	0.5 - 3.0	0.35	0.15 - 0.50	SL 550 C
	400	400 - 600	0.5 - 3.0	0.35	0.10 - 0.50	SL 554 C
	400	400 - 600	0.5 - 3.0	0.30	0.15 - 0.50	SL 654 C
	500	400 - 700	0.5 - 3.0	0.40	0.20 - 0.80	SL 658 C

Cutting Data Recommendations for Turning Ductile Cast Iron

SPK mixed ceramic

TENSILE STRENGTH UTS (N/mm ²)	CUTTING SPEED v_c (m/min)		CUTTING DEPTH a_p (mm)	FEED RATE f (mm)		GRADE
	RECOMMENDED VALUE	OVERALL RANGE		RECOMMENDED VALUE	OVERALL RANGE	
6.3 / Finishing						
400 - 600	500	300 - 700	0.30 - 1.0	0.20	0.10 - 0.25	SH 2
	600	300 - 800	0.30 - 1.0	0.20	0.10 - 0.25	SH 4
700	500	300 - 600	0.25 - 0.5	0.15	0.08 - 0.25	SH 2
	500	300 - 600	0.25 - 0.5	0.15	0.08 - 0.25	SH 4
0.8 / Fine finishing						
400 - 600	600	400 - 700	0.25 - 0.5	0.15	0.10 - 0.20	SH 2
	600	400 - 700	0.25 - 0.5	0.15	0.10 - 0.20	SH 4
700	400	300 - 600	0.25 - 0.5	0.12	0.08 - 0.20	SH 2
	500	300 - 600	0.25 - 0.5	0.12	0.08 - 0.20	SH 4

Cutting Data Recommendations for Turning Chilled Cast Iron

SPK mixed ceramic

HARDNESS Shore C	CUTTING SPEED v_c (m/min)		CUTTING DEPTH a_p (mm)	FEED RATE f (mm)		GRADE
	RECOMMENDED VALUE	OVERALL RANGE		RECOMMENDED VALUE	OVERALL RANGE	
12.5  Semi-finishing						
53	120	90 - 200	0.5 - 5.0	0.22	0.18 - 0.30	SH 2
59	100	75 - 180	0.5 - 5.0	0.20	0.16 - 0.25	SH 2
66	90	60 - 160	0.5 - 5.0	0.18	0.14 - 0.22	SH 2
73	80	50 - 140	0.5 - 5.0	0.16	0.12 - 0.20	SH 2
	90	50 - 140	0.5 - 5.0	0.18	0.12 - 0.20	SH 4
79	70	45 - 120	0.5 - 5.0	0.16	0.10 - 0.17	SH 2
	80	45 - 120	0.5 - 5.0	0.18	0.10 - 0.20	SH 4
86	60	40 - 100	0.5 - 5.0	0.12	0.08 - 0.16	SH 2
	70	40 - 100	0.5 - 5.0	0.14	0.08 - 0.16	SH 4
93	50	30 - 80	0.5 - 5.0	0.10	0.06 - 0.15	SH 2
	60	30 - 80	0.5 - 5.0	0.12	0.06 - 0.15	SH 4

Cutting Data Recommendations for Turning Hardened Steel

SPK mixed ceramic

HARDNESS (HRC)	CUTTING SPEED v_c (m/min)		CUTTING DEPTH a_p (mm)	FEED RATE f (mm/rev)		GRADE
	RECOMMENDED VALUE	OVERALL RANGE		RECOMMENDED VALUE	OVERALL RANGE	
0.8/ ∇ Fine finishing						
58 - 62	140	120 - 200	0.10 - 0.5	0.15	0.10 - 0.30	SH 2
58 - 62	160	120 - 250	0.10 - 0.5	0.15	0.10 - 0.30	SH 4

Designation System for Turning Inserts according to ISO 1832

V	35°	
D	55°	
E	75°	
C	80°	
M	86°	
K	55°	
B	82°	
A	85°	
R		
S	90°	
T	60°	
W	80°	
L		
P	108°	
H	120°	
O	135°	

Insert shape

N	0°
A	3°
B	5°
C	7°
P	11°
D	15°
E	20°
F	25°
G	30°
O	Clearance angle which requires special data.

Normal clearance angle α_n

Inscribed circle d mm	 RC, RN S	 O 135°	 T 60°					 W 80°	Inscribed circle d mm	 RB (Type MO)
				C 80°	E 75°	D 55°	V 35°			
3.97			06					6.0	06	
5.56			09					7.0	07	
6.35			11	06		07		8.0	08	
9.52	09		16	09		11	16	06	09	
10.00						12		10.0	10	
12.70	12	05	22	12	13	15	22	08	12.0	12
15.88	15	06	27	16				16.0	16	
19.05	19		33					20.0	20	
25.40	25		44					25.0	25	

Insert size

S

N

G

N

12

07

Tolerances

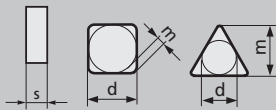

* Permissible deviations for the insert shape, depending on the insert size

	S ± mm	d ± mm	m ± mm	Inscribed circle d mm	Tolerance class			
					m ± mm		d ± mm	
					M	U	J, K, L, M	U
A	0.025	0.025	0.005	3.97 5.56 6.35 9.52 12.70 15.88 19.05 25.40	0.08	0.13	0.05	0.08
C	0.025	0.025	0.013					
E	0.025	0.025	0.025					
F	0.025	0.013	0.005		0.13	0.20	0.08	0.13
G	0.130	0.025	0.025					
H	0.025	0.013	0.013		0.15	0.27	0.10	0.18
J	0.025	0.05-0.13*	0.005					
K	0.025	0.05-0.13*	0.013		0.18	0.38	0.13	0.25
L	0.025	0.05-0.13*	0.025					
M	0.130	0.05-0.13*	0.08-0.18*					
U	0.130	0.08-0.25*	0.13-0.38*					

Insert type

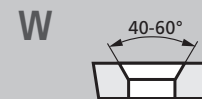

X Special design

Insert thickness

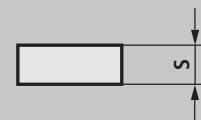

01	1.59
02	2.38
03	3.18
T3	3.97
04	4.76
06	6.35
07	7.94
09	9.52
12	12.7



F Sharp	E Rounded
T Chamfered	S Chamfered and rounded
K Double chamfered	P Double chamfered and rounded
Corner design	

Insert with IKS-PRO notch

Design variants

08 T 02020 -D0 95Z025

Corner radius							
Insert with corner radius		Insert with cutting edge					
				Approach angle of the main cutting edge κ_r		Clearance angle α_n	
00	RN, RC						
M0	RB						
02	0.2						
04	0.4						
08	0.8	A	45°	N	0°		
12	1.2	D	60°	C	7°		
16	1.6	E	75°	P	11°		
24	2.4	F	85°	D	15°		
32	3.2	P	90°	E	20°		
40	4.0	Z	other angles	F	25°		
ZZ	Special design						

















Chamfer design

Chamfer width b_γ in 1/100 mm and angle γ_s without degree symbol

e.g.
0.10 x 20° = 01020
0.05 x 20° = 00520

Designation key for ZZ geometries

<p style="text-align: center;">Approach angle</p> <p style="text-align: center;">e.g. 85 = 85° 95 = 95°</p>	<p style="text-align: center;">Width of the ZZ chamfer</p> <p style="text-align: center;">e.g. 025 = 0.25 mm 050 = 0.50 mm</p>
---	--

CCGW	CCGX, CCMX	CNGA, CNMA	CNGN
			
Page 20	Page 20	Page 20, 24	Page 21-22
CNGX, CNMX	CNGX-DO	DCMX	DNGA, DNMA
			
Page 23-25	Page 23	Page 26	Page 26, 28
DNGN	DNGX	DNGX-DO	ENGN
			
Page 26-27	Page 27, 28	Page 28	Page 29
RBGN	RCGN	RCGX	RNGN
			
Page 30-31	Page 31	Page 32	Page 33-34



SCGN, SCUN	SCMX	SNGA, SNMA	SNGN, SNMN
Page 35, 37	Page 37	Page 37, 44	Page 38-41, 44
SNGX, SNMX	SNGX-DO	SPUN	TCGN, TCUN
Page 41, 43, 45	Page 42-43	Page 46	Page 47
TCGW	TNGA, TNMA	TNGN, TNMN	TPGN, TPUN
Page 47	Page 47, 49	Page 48-49	Page 49-50
VNGA	VNGN	VNGX	VNGX-DO
Page 51	Page 51	Page 51	Page 51

Ceramic Inserts for Turning

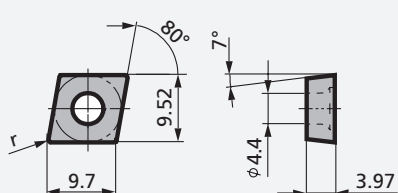
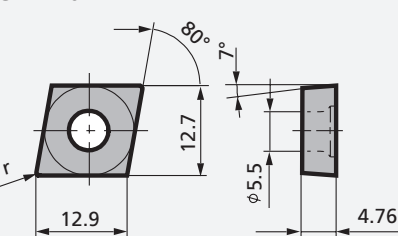
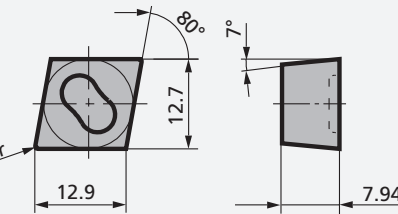
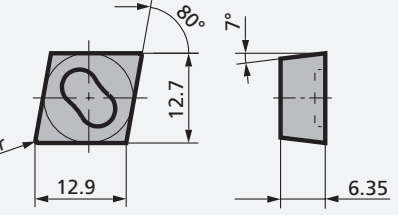
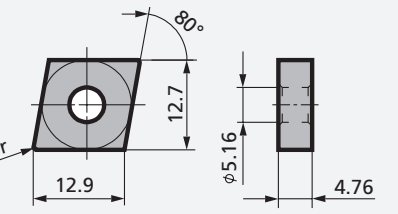
INSERT	ISO	GRADE	SPK REF. NO.
CCGW 09 T3 .. T 	CCGW 09 T3 04 T 00520	SH 2	36.56.330.03.7
	CCGW 09 T3 08 T 00520	SH 2	36.56.324.03.7
	CCGW 09 T3 12 T 00520	SH 2	36.56.327.03.7
	CCGW 09 T3 04 T 01020	SL 500	36.56.330.20.0
	CCGW 09 T3 08 T 01020	SL 500	36.56.324.20.0
		SL 550 C	17.56.324.20.3
	CCGW 09 T3 12 T 01020	SL 500	36.56.327.20.0
CCGW 12 04 .. T 	CCGW 12 04 08 T 01020	SL 500	36.56.328.20.0
		SL 550 C	17.56.328.20.3
	CCGW 12 04 12 T 01020	SL 500	36.56.329.20.0
		SL 550 C	17.56.329.20.3
CCGX 12 07 .. T 	CCGX 12 07 16 T 02020	SN 80 E	36.52.027.04.4
CCMX 12 06 .. T 	CCMX 12 06 08 T 02020	SL 500	36.52.020.04.0
	CCMX 12 06 12 T 02020	SL 500	36.52.021.04.0
	CCMX 12 06 16 T 02020	SL 500	36.52.022.04.0
CNGA 12 04 .. T 	CNGA 12 04 08 T 02020	SH 2	36.56.100.04.7
	CNGA 12 04 12 T 02020	SH 2	36.56.101.04.7

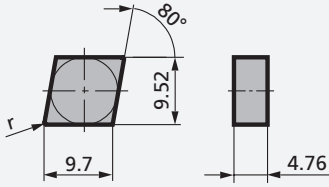
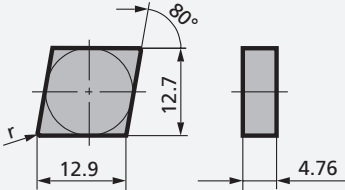
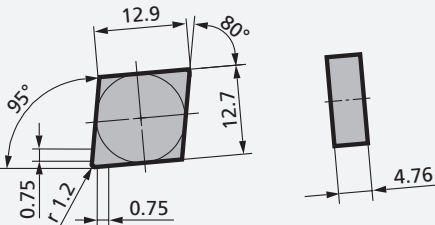
INSERT	ISO	GRADE	SPK REF. NO.
CNGN 09 04 .. T 	CNGN 09 04 08 T 00520	SL 500	36.50.273.03.0
	CNGN 09 04 12 T 00520	SL 500	36.50.274.03.0
	CNGN 09 04 16 T 00520	SL 500	36.50.275.03.0
CNGN 12 04 .. T 	CNGN 12 04 04 T 00520	SH 2	36.50.167.03.7
	CNGN 12 04 08 T 00520	SH 2	36.50.168.03.7
	CNGN 12 04 12 T 00520	SH 2	36.50.169.03.7
	CNGN 12 04 16 T 00520	SN 60	36.50.170.03.5
	CNGN 12 04 04 T 02020	SH 2	36.50.167.04.7
	CNGN 12 04 08 T 02020	SH 2	36.50.168.04.7
		SL 500	36.50.168.04.0
		SL 506	19.50.168.04.1
	CNGN 12 04 12 T 02020	SH 2	36.50.169.04.7
		SL 500	36.50.169.04.0
		SL 506	19.50.169.04.1
		SN 60	36.50.169.04.5
	CNGN 12 04 16 T 02020	SH 2	36.50.170.04.7
	SL 500	36.50.170.04.0	
	SL 506	19.50.170.04.1	
CNGN 12 04 12 T - 95Z075 	CNGN 12 04 12 T 00520 - 95Z075	SH 2	36.50.322.03.7
		SL 500	36.50.322.03.0

Ceramic Inserts for Turning

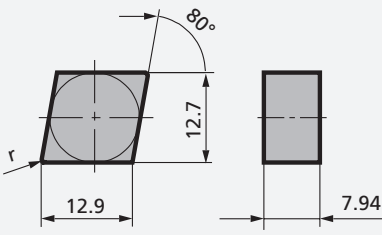
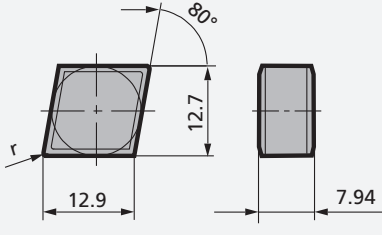
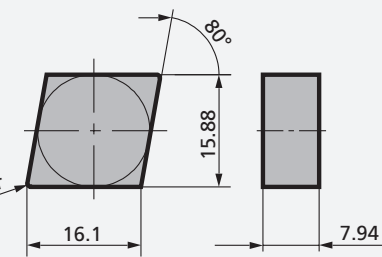
INSERT	ISO	GRADE	SPK REF. NO.
CNGN 12 07 .. T 	CNGN 12 07 08 T 02020	SH 2	36.50.022.04.7
		SH 4	19.50.022.04.7
		SL 500	36.50.022.04.0
		SN 80 E	36.50.022.04.4
	CNGN 12 07 12 T 02020	SH 2	36.50.023.04.7
		SH 4	19.50.023.04.0
		SL 500	36.50.023.04.0
		SN 80 E	36.50.023.04.4
		SN 180	13.50.023.04.7
	CNGN 12 07 16 T 02020	SH 2	36.50.024.04.7
		SH 4	19.50.024.04.7
		SL 500	36.50.024.04.0
		SL 550 C	17.50.024.04.3
		SN 80 E	36.50.024.04.4
	SN 180	13.50.024.04.7	
CNGN 12 07 30 T 02020	SH 2	36.50.027.04.7	
CNGN 12 07 .. P 	CNGN 12 07 12 P 85	SH 2	36.50.023.85.7
	CNGN 12 07 16 P 85	SH 2	36.50.024.85.7
CNGN 16 07 .. T 	CNGN 16 07 12 T 02020	SN 60	36.50.038.04.5
	CNGN 16 07 16 T 02020	SH 2	36.50.042.04.7
		SL 500	36.50.042.04.0
		SN 80 E	36.50.042.04.4
	CNGN 16 07 16 T 03030	SH 2	36.50.042.54.7

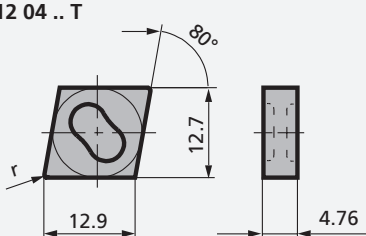
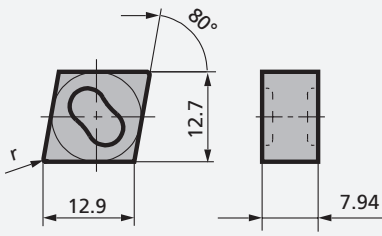
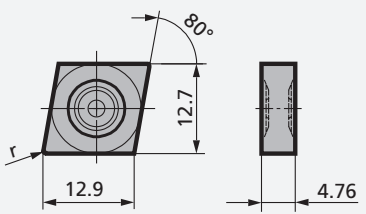
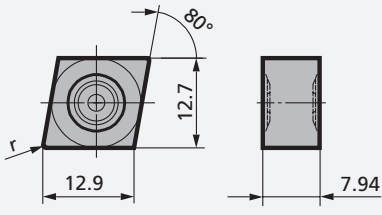
INSERT	ISO	GRADE	SPK REF. NO.
CNGX 12 04 .. T 	CNGX 12 04 12 T 02020	SL 500	36.50.226.04.0
	CNGX 12 04 16 T 02020	SL 500	36.50.227.04.0
CNGX 12 07 .. T 	CNGX 12 07 08 T 00520	SH 2	36.54.095.03.7
	CNGX 12 07 12 T 00520	SH 2	36.54.096.03.7
	CNGX 12 07 08 T 02020	SH 2	36.54.095.04.7
	CNGX 12 07 12 T 02020	SH 2	36.54.096.04.7
	CNGX 12 07 16 T 02020	SH 2	36.54.097.04.7
CNGX 12 04 .. T - DO 	CNGX 12 04 12 T 02020 - DO	SL 606	19.50.226.04.8
	CNGX 12 04 16 T 02020 - DO	SL 606	19.50.227.04.8
CNGX 12 07 .. T - DO 	CNGX 12 07 08 T 02020 - DO	SH 4	19.50.030.04.7
		SL 506	19.50.030.04.1
		SL 508	19.50.030.04.2
	CNGX 12 07 12 T 02020 - DO	SH 4	19.50.031.04.7
		SL 506	19.50.031.04.1
		SL 508	19.50.031.04.2
		SL 606	19.50.031.04.8
		SL 608	19.50.031.04.3
		SL 654 C	19.50.031.04.5
		SL 658 C	21.50.031.04.0
	SN 180	13.50.031.04.7	

Ceramic Inserts for Turning

INSERT	ISO	GRADE	SPK REF. NO.
CNGX 12 07 .. T - DO 	CNGX 12 07 16 T 02020 - DO	SH 4	19.50.032.04.7
		SL 506	19.50.032.04.1
		SL 508	19.50.032.04.2
		SL 606	19.50.032.04.8
		SL 608	19.50.032.04.3
		SL 654 C	19.50.032.04.5
		SL 658 C	21.50.032.04.0
		SN 180	13.50.032.04.7
CNGX 16 07 .. T - DO 	CNGX 16 07 12 T 02020 - DO	SL 508	19.50.081.04.2
	CNGX 16 07 16 T 02020 - DO	SL 508	19.50.082.04.2
		SL 608	19.50.082.04.3
		SL 658 C	21.50.082.04.0
CNGX 19 07 .. T - DO 	CNGX 19 07 16 T 02020 - DO	SL 658 C	21.50.375.04.0
CNMA 12 04 .. T 	CNMA 12 04 08 T 02020	SL 500	36.56.110.04.0
		SL 550 C	17.56.110.04.3
	CNMA 12 04 12 T 02020	SL 500	36.56.111.04.0
		SL 550 C	17.56.111.04.3
	CNMA 12 04 16 T 02020	SL 500	36.56.112.04.0

INSERT	ISO	GRADE	SPK REF. NO.
CNMX 12 04 .. T 	CNMX 12 04 12 T 02020	SL 408	13.54.228.04.4
	CNMX 12 04 16 T 02020	SL 406	13.54.229.04.3
		SL 408	13.54.229.04.4
CNMX 12 07 .. T 	CNMX 12 07 08 T 02020	SL 500	36.54.030.04.0
		SL 550 C	17.54.030.04.3
		SN 60	36.54.030.04.5
		SN 80 E	36.54.030.04.4
	CNMX 12 07 12 T 02020	SL 406	13.54.031.04.3
		SL 408	13.54.031.04.4
		SL 500	36.54.031.04.0
		SL 550 C	17.54.031.04.3
		SL 554 C	17.54.031.04.4
		SN 60	36.54.031.04.5
		SN 80 E	36.54.031.04.4
	CNMX 12 07 16 T 02020	SL 406	13.54.032.04.3
		SL 408	13.54.032.04.4
		SL 500	36.54.032.04.0
		SL 550 C	17.54.032.04.3
	SL 554 C	17.54.032.04.4	
	SN 60	36.54.032.04.5	
	SN 80 E	36.54.032.04.4	
CNMX 12 07 16 T 03030	SL 500	36.54.032.54.0	
CNMX 16 07 .. T 	CNMX 16 07 12 T 02020	SL 500	36.54.081.04.0
		SL 550 C	17.54.081.04.3
		SL 554 C	17.54.081.04.4
		SN 80 E	36.54.081.04.4
	CNMX 16 07 16 T 02020	SL 500	36.54.082.04.0
		SL 550 C	17.54.082.04.3
		SL 554 C	17.54.082.04.4
	SN 80 E	36.54.082.04.4	

Ceramic Inserts for Turning

INSERT	ISO	GRADE	SPK REF. NO.
DCMX 15 06 .. T 	DCMX 15 06 08 T 02020	SL 500	36.54.555.04.0
	DCMX 15 06 12 T 02020	SL 500	36.54.556.04.0
	DCMX 15 06 16 T 02020	SL 500	36.54.557.04.0
DNGA 15 04 .. T 	DNGA 15 04 08 T 02020	SH 2	36.56.210.04.7
	DNGA 15 04 12 T 02020	SH 2	36.56.211.04.7
DNGA 15 06 .. T 	DNGA 15 06 08 T 02020	SH 2	36.52.236.04.7
	DNGA 15 06 12 T 02020	SH 2	36.52.237.04.7
	DNGA 15 06 16 T 02020	SH 2	36.52.238.04.7
DNGN 12 04 .. T 	DNGN 12 04 04 T 02020	SH 2	36.50.196.04.7
	DNGN 12 04 08 T 02020	SH 2	36.50.197.04.7
	DNGN 12 04 12 T 02020	SH 2	36.50.198.04.7
DNGN 12 07 .. T 	DNGN 12 07 08 T 00520	SH 2	36.50.091.03.7
	DNGN 12 07 08 T 02020	SH 2	36.50.091.04.7
	DNGN 12 07 12 T 02020	SH 2	36.50.092.04.7
	DNGN 12 07 16 T 02020	SH 2	36.50.093.04.7

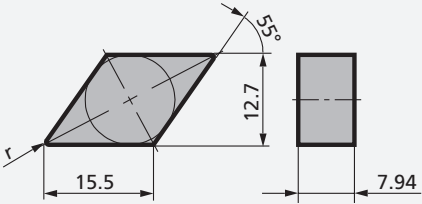
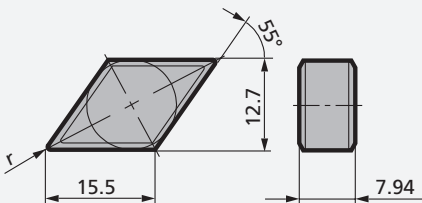
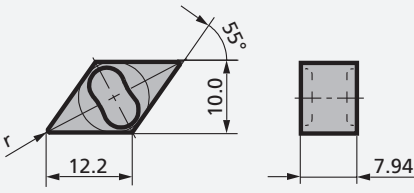
INSERT	ISO	GRADE	SPK REF. NO.
DNGN 15 07 .. T 	DNGN 15 07 04 T 00520	SH 2	36.50.076.03.7
	DNGN 15 07 12 T 00520	SH 4	19.50.078.03.7
	DNGN 15 07 16 T 00520	SH 4	19.50.079.03.7
	DNGN 15 07 04 T 02020	SH 2	36.50.076.04.7
		SN 60	36.50.076.04.5
	DNGN 15 07 08 T 02020	SH 4	19.50.077.04.7
		SN 60	36.50.077.04.5
		SN 80 E	36.50.077.04.4
	DNGN 15 07 12 T 02020	SH 2	36.50.078.04.7
		SH 4	19.50.078.04.7
		SN 180	13.50.078.04.7
		SN 60	36.50.078.04.5
		SN 80 E	36.50.078.04.4
	DNGN 15 07 16 T 02020	SH 2	36.50.079.04.7
		SH 4	19.50.079.04.7
		SN 180	13.50.079.04.7
		SN 60	36.50.079.04.5
		SN 80 E	36.50.079.04.4
DNGN 15 07 .. P 	DNGN 15 07 16 P 85	SH 2	36.50.079.85.7
DNGX 12 07 .. T 	DNGX 12 07 08 T 00520	SH 2	36.54.106.03.7
	DNGX 12 07 12 T 00520	SH 2	36.54.107.03.7
	DNGX 12 07 16 T 00520	SH 2	36.54.108.03.7
	DNGX 12 07 08 T 02020	SH 2	36.54.106.04.7
	DNGX 12 07 12 T 02020	SH 2	36.54.107.04.7
	DNGX 12 07 16 T 02020	SH 2	36.54.108.04.7

Ceramic Inserts for Turning

INSERT	ISO	GRADE	SPK REF. NO.	
DNGX 12 07 .. T - DO 	DNGX 12 07 08 T 02020 - DO	SL 506	19.50.358.04.1	
		SL 508	19.50.358.04.2	
		SL 654 C	19.50.358.04.5	
		SL 658 C	21.50.358.04.0	
	DNGX 12 07 12 T 02020 - DO	SL 506	19.50.359.04.1	
		SL 654 C	19.50.359.04.5	
		SL 658 C	21.50.359.04.0	
	DNGX 12 07 16 T 02020 - DO	SL 506	19.50.357.04.1	
		SL 654 C	19.50.357.04.5	
		SL 658 C	21.50.357.04.0	
	DNGX 15 07 .. T 	DNGX 15 07 08 T 02020	SH 2	36.54.120.04.7
		DNGX 15 07 12 T 02020	SH 2	36.54.121.04.7
DNGX 15 07 16 T 02020		SH 2	36.54.122.04.7	
DNGX 15 07 .. T - DO 	DNGX 15 07 08 T 02020 - DO	SH 4	19.50.010.04.7	
	DNGX 15 07 12 T 02020 - DO	SH 4	19.50.011.04.7	
		SL 506	19.50.011.04.1	
		SL 508	19.50.011.04.2	
		SL 654 C	19.50.011.04.5	
		SL 658 C	21.50.011.04.0	
		SN 180	13.50.011.04.7	
	DNGX 15 07 16 T 02020 - DO	SH 4	19.50.012.04.7	
		SL 506	19.50.012.04.1	
		SL 508	19.50.012.04.2	
		SL 654 C	19.50.012.04.5	
		SL 658 C	21.50.012.04.0	
		SN 180	13.50.012.04.7	
	DNMA 15 06 .. T 	DNMA 15 06 08 T 02020	SL 500	36.56.013.04.0
DNMA 15 06 12 T 02020		SL 500	36.56.014.04.0	
DNMA 15 06 16 T 02020		SL 500	36.56.015.04.0	

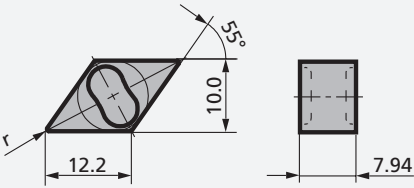
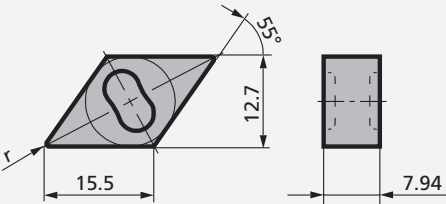
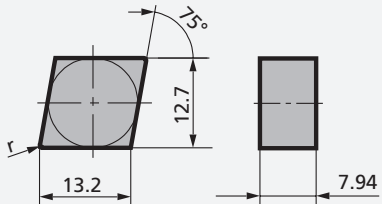
INSERT	ISO	GRADE	SPK REF. NO.
DNMX 12 07 .. T 	DNMX 12 07 08 T 02020	SL 550 C	17.54.002.04.3
		SN 60	36.54.002.04.5
		SN 80 E	36.54.002.04.4
	DNMX 12 07 12 T 02020	SL 500	36.54.003.04.0
		SL 550 C	17.54.003.04.3
		SN 60	36.54.003.04.5
		SN 80 E	36.54.003.04.4
	DNMX 12 07 16 T 02020	SL 500	36.54.004.04.0
		SL 550 C	17.54.004.04.3
		SN 60	36.54.004.04.5
		SN 80 E	36.54.004.04.4
	DNMX 15 07 .. T 	DNMX 15 07 08 T 02020	SL 500
		SL 550 C	17.54.010.04.3
DNMX 15 07 12 T 02020		SL 406	13.54.011.04.3
		SL 408	13.54.011.04.4
		SL 500	36.54.011.04.0
		SL 550 C	17.54.011.04.3
		SN 60	36.54.011.04.5
		SN 80 E	36.54.011.04.4
DNMX 15 07 16 T 02020		SL 406	13.54.012.04.3
		SL 408	13.54.012.04.4
		SL 500	36.54.012.04.0
		SL 550 C	17.54.012.04.3
	SN 60	36.54.012.04.5	
	SN 80 E	36.54.012.04.4	
ENGN 13 07 .. T 	ENGN 13 07 04 T 02020	SH 2	36.50.017.04.7
	ENGN 13 07 08 T 02020	SH 2	36.50.018.04.7
		SL 500	36.50.018.04.0
		SN 60	36.50.018.04.5
		SN 80 E	36.50.018.04.4
	ENGN 13 07 12 T 02020	SH 2	36.50.019.04.7
		SL 500	36.50.019.04.0
		SN 60	36.50.019.04.5
		SN 80 E	36.50.019.04.4
	ENGN 13 07 16 T 02020	SH 2	36.50.020.04.7
		SL 500	36.50.020.04.0
		SN 60	36.50.020.04.5
	SN 80 E	36.50.020.04.4	

Ceramic Inserts for Turning

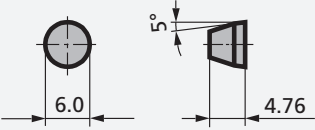
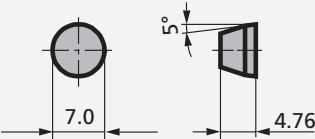
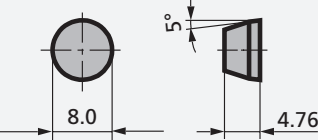
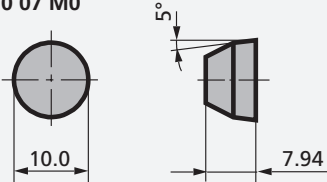
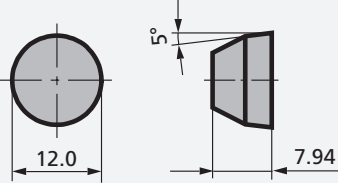
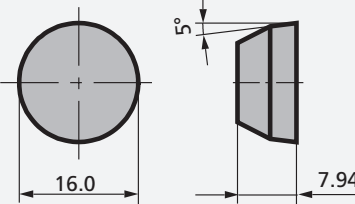
INSERT	ISO	GRADE	SPK REF. NO.
RBGN 06 04 M0 	RBGN 06 04 M0 S 05015	SH 2	36.42.192.31.7
RBGN 07 04 M0 	RBGN 07 04 M0 S 05015	SH 2	36.42.193.31.7
RBGN 08 04 M0 	RBGN 08 04 M0 P 86	SH 2	36.42.194.86.7
	RBGN 08 04 M0 S 05015	SH 2	36.42.194.31.7
RBGN 10 07 M0 	RBGN 10 07 M0 P 86	SH 2	36.42.195.86.7
	RBGN 10 07 M0 S 05015	SH 2	36.42.195.31.7
	RBGN 10 07 M0 T 02020	SH 2	36.42.195.04.7
		SL 500	36.42.195.04.0
RBGN 12 07 M0 	RBGN 12 07 M0 P 86	SH 2	36.42.196.86.7
	RBGN 12 07 M0 S 20015	SH 2	36.42.196.26.7
	RBGN 12 07 M0 T 02020	SH 2	36.42.196.04.7
		SL 500	36.42.196.04.0
RBGN 16 07 M0 	RBGN 16 07 M0 P 86	SH 2	36.42.197.86.7
	RBGN 16 07 M0 S 20015	SH 2	36.42.197.26.7
	RBGN 16 07 M0 T 02020	SH 2	36.42.197.04.7

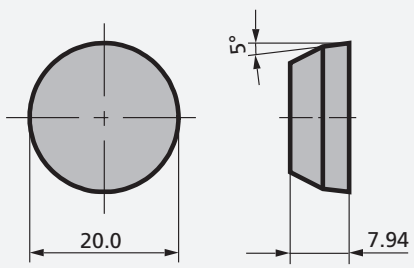
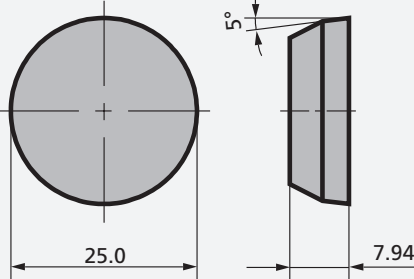
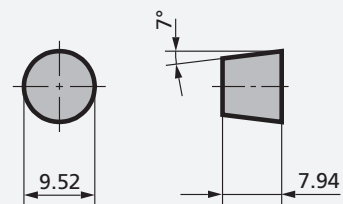
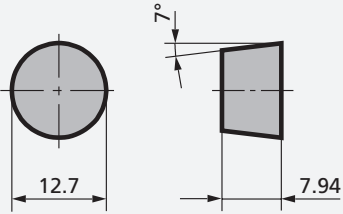
INSERT	ISO	GRADE	SPK REF. NO.
RBGN 20 07 M0 	RBGN 20 07 M0 P 86	SH 2	36.42.198.86.7
	RBGN 20 07 M0 S 20015	SH 2	36.42.198.26.7
RBGN 25 07 M0 	RBGN 25 07 M0 P 86	SH 2	36.42.168.86.7
	RBGN 25 07 M0 S 20015	SH 2	36.42.168.26.7
RCGN 09 07 00 	RCGN 09 07 00 S 20015	SH 2	36.42.028.26.7
	RCGN 09 07 00 T 02020	SH 2	36.42.028.04.7
		SN 80 E	36.42.028.04.4
RCGN 12 07 00 	RCGN 12 07 00 S 20015	SH 2	36.42.029.26.7
	RCGN 12 07 00 T 02020	SH 2	36.42.029.04.7

Ceramic Inserts for Turning

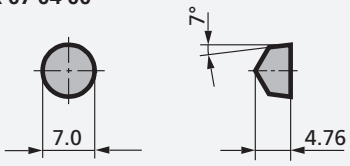
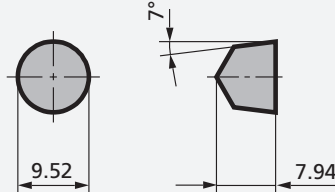
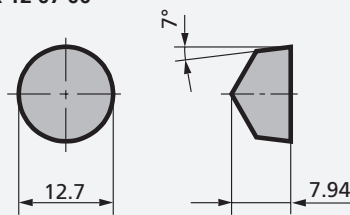
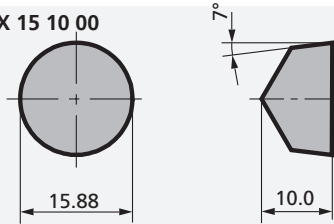
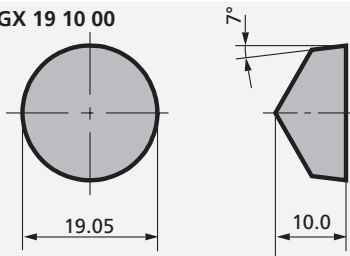
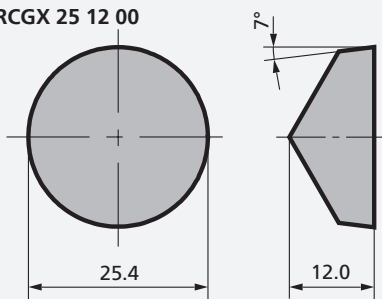
INSERT	ISO	GRADE	SPK REF. NO.
RCGX 07 04 00 	RCGX 07 04 00 S 05015	SH 2	36.42.173.31.7
RCGX 09 07 00 	RCGX 09 07 00 P 86	SH 2	36.42.103.86.7
	RCGX 09 07 00 S 20015	SH 2	36.42.103.26.7
	RCGX 09 07 00 T 02020	SH 2	36.42.103.04.7
		SL 500	36.42.103.04.0
		SN 80 E	36.42.103.04.4
RCGX 12 07 00 	RCGX 12 07 00 P 86	SH 2	36.42.104.86.7
	RCGX 12 07 00 S 20015	SH 2	36.42.104.26.7
	RCGX 12 07 00 T 02020	SH 2	36.42.104.04.7
		SL 500	36.42.104.04.0
		SN 80 E	36.42.104.04.4
RCGX 15 10 00 	RCGX 15 10 00 P 86	SH 2	36.42.105.86.7
	RCGX 15 10 00 S 20015	SH 2	36.42.105.26.7
	RCGX 15 10 00 T 02020	SN 80 E	36.42.105.04.4
RCGX 19 10 00 	RCGX 19 10 00 P 86	SH 2	36.42.106.86.7
	RCGX 19 10 00 S 20015	SH 2	36.42.106.26.7
	RCGX 19 10 00 T 02020	SN 60	36.42.106.04.5
		SN 80 E	36.42.106.04.4
RCGX 25 12 00 	RCGX 25 12 00 P 86	SH 2	36.42.111.86.7
	RCGX 25 12 00 S 20015	SH 2	36.42.111.26.7

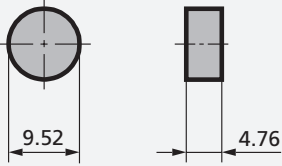
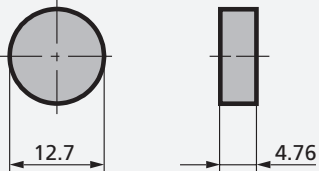
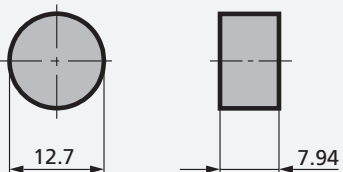
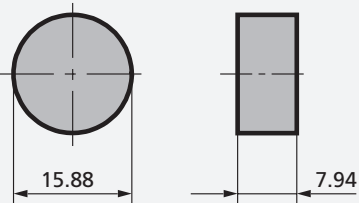
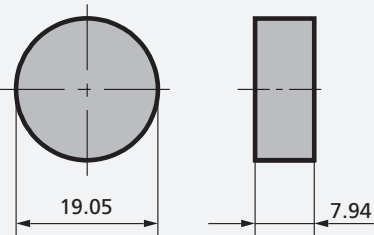
INSERT	ISO	GRADE	SPK REF. NO.
RNGN 09 04 00 	RNGN 09 04 00 T 02020	SH 2	36.40.018.04.7
		SL 500	36.40.018.04.0
		SN 60	36.40.018.04.5
RNGN 12 04 00 	RNGN 12 04 00 T 02020	SH 2	36.40.027.04.7
		SL 500	36.40.027.04.0
		SN 60	36.40.027.04.5
RNGN 12 07 00 	RNGN 12 07 00 P 85	SH 2	36.40.002.85.7
	RNGN 12 07 00 S 20015	SH 2	36.40.002.27.7
	RNGN 12 07 00 T 00520	SH 2	36.40.002.03.7
	RNGN 12 07 00 T 02020	SH 2	36.40.002.04.7
		SL 500	36.40.002.04.0
		SN 60	36.40.002.04.5
		SN 80 E	36.40.002.04.4
RNGN 15 07 00 	RNGN 15 07 00 P 85	SH 2	36.40.023.85.7
	RNGN 15 07 00 S 20015	SH 2	36.40.023.27.7
RNGN 19 07 00 	RNGN 19 07 00 P 85	SH 2	36.40.005.85.7
	RNGN 19 07 00 S 20015	SH 2	36.40.005.26.7

Ceramic Inserts for Turning

INSERT	ISO	GRADE	SPK REF. NO.
RNGN 25 07 00	RNGN 25 07 00 P 85	SH 2	36.40.038.85.7

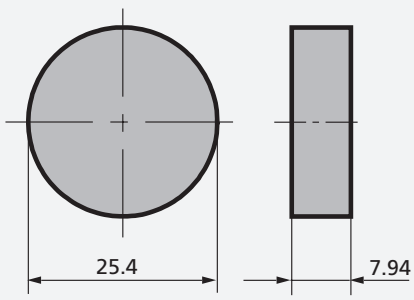

The technical drawing shows two views of the ceramic insert. The left view is a circular top view with a diameter dimensioned as 25.4. The right view is a side view showing a rectangular profile with a width dimensioned as 7.94. Both views include centerlines to indicate the axis of symmetry.

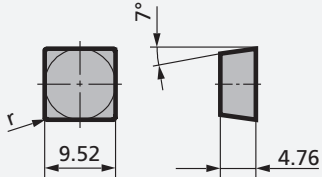
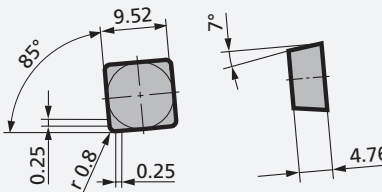
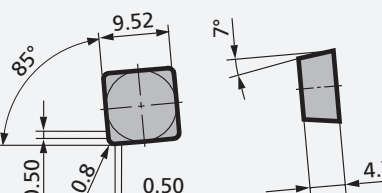
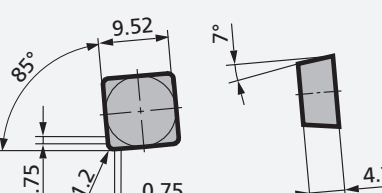
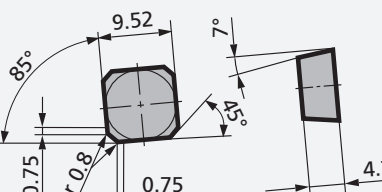
INSERT	ISO	GRADE	SPK REF. NO.
SCGN 09 04 .. T 	SCGN 09 04 12 T 00520	SL 500	36.12.093.03.0
		SL 506	19.12.093.03.1
		SN 60	36.12.093.03.5
SCGN 09 04 08 . - 85Z025 	SCGN 09 04 08 E - 85Z025	SL 500	36.12.299.70.0
		SL 506	19.12.299.70.1
	SCGN 09 04 08 F - 85Z025	SL 500	36.12.299.06.0
		SL 506	19.12.299.06.1
	SCGN 09 04 08 S 00520 - 85Z025	SL 500	36.12.299.73.0
		SL 506	19.12.299.73.1
SCGN 09 04 08 F - 85Z050 	SCGN 09 04 08 F - 85Z050	SL 500	36.12.312.06.0
		SL 506	19.12.312.06.1
SCGN 09 04 12 T - 85Z075 	SCGN 09 04 12 T 00520 - 85Z075	SL 500	36.12.368.03.0
		SL 506	19.12.368.03.1
SCGN 09 04 AC T - 85Z075 R08 	SCGN 09 04 AC T 00520 - 85Z075 R08	SL 500	36.12.366.03.0
		SL 506	19.12.366.03.1

Ceramic Inserts for Turning

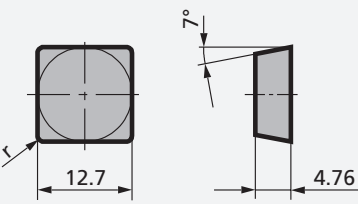
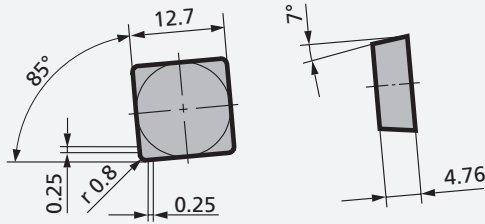
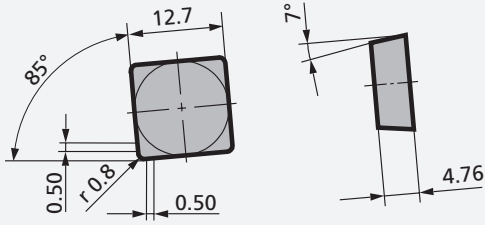
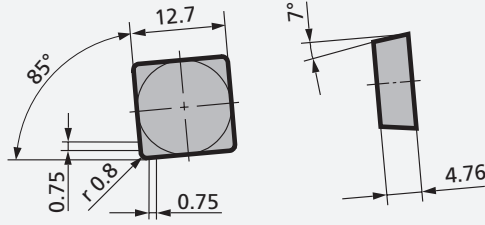
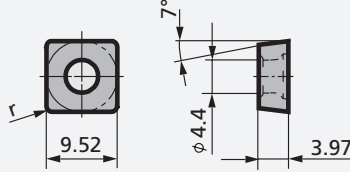
INSERT	ISO	GRADE	SPK REF. NO.
SCGN 12 04 .. T 	SCGN 12 04 08 T 00520	SH 2	36.12.098.03.7
		SL 506	19.12.098.03.1
		SN 60	36.12.098.03.5
	SCGN 12 04 12 T 00520	SH 2	36.12.099.03.7
		SL 506	19.12.099.03.1
		SN 60	36.12.099.03.5
SCGN 12 04 08 . - 85Z025 	SCGN 12 04 08 F - 85Z025	SL 500	36.12.301.06.0
		SL 506	19.12.301.06.1
	SCGN 12 04 08 T 00520 - 85Z025	SL 500	36.12.301.03.0
		SL 506	19.12.301.03.1
SCGN 12 04 08 F - 85Z050 	SCGN 12 04 08 F - 85Z050	SL 500	36.12.306.06.0
		SL 506	19.12.306.06.1
SCGN 12 04 08 T - 85Z075 	SCGN 12 04 08 T 00520 - 85Z075	SL 500	36.12.370.03.0
		SL 506	19.12.370.03.1
SCGW 09 T3 .. T 	SCGW 09 T3 04 T 00520	SH 2	36.16.518.03.7
	SCGW 09 T3 08 T 00520	SH 2	36.16.511.03.7
	SCGW 09 T3 04 T 01020	SL 500	36.16.518.20.0
	SCGW 09 T3 08 T 01020	SL 500	36.16.511.20.0
		SL 550 C	17.16.511.20.3
	SCGW 09 T3 12 T 01020	SL 500	36.16.515.20.0
		SL 550 C	17.16.515.20.3

INSERT	ISO	GRADE	SPK REF. NO.
	SCGW 12 04 08 T 01020	SL 500	36.16.512.20.0
		SL 550 C	17.16.512.20.3
	SCGW 12 04 12 T 01020	SL 500	36.16.516.20.0
		SL 550 C	17.16.516.20.3
	SCMX 12 06 08 T 00520	SL 500	36.14.656.03.0
	SCMX 12 06 12 T 02020	SL 500	36.14.657.04.0
	SCUN 09 04 12 T 00520	SL 500	36.12.593.03.0
		SN 60	36.12.593.03.5
	SCUN 09 04 16 T 00520	SL 500	36.12.594.03.0
		SN 60	36.12.594.03.5
	SCUN 12 04 08 T 00520	SH 2	36.12.598.03.7
		SN 60	36.12.598.03.5
	SCUN 12 04 12 T 00520	SH 2	36.12.599.03.7
		SL 500	36.12.599.03.0
		SN 60	36.12.599.03.5
	SCUN 12 04 16 T 00520	SH 2	36.12.600.03.7
		SN 60	36.12.600.03.5
	SCUN 12 04 16 T 02020	SL 500	36.12.600.04.0
	SNGA 12 04 08 T 02020	SH 2	36.16.101.04.7
	SNGA 12 04 12 T 02020	SH 2	36.16.102.04.7

Ceramic Inserts for Turning

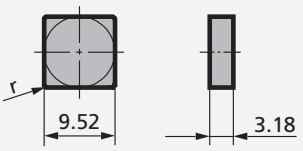
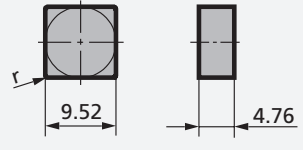
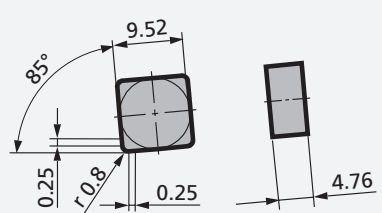
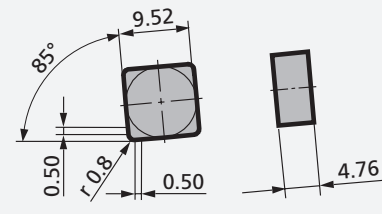
INSERT	ISO	GRADE	SPK REF. NO.
SNGN 09 03 .. T 	SNGN 09 03 04 T 00520	SN 60	36.10.053.03.5
	SNGN 09 03 08 T 00520	SH 2	36.10.054.03.7
		SN 60	36.10.054.03.5
	SNGN 09 03 04 T 02020	SN 60	36.10.053.04.5
	SNGN 09 03 08 T 02020	SL 500	36.10.054.04.0
		SN 80 E	36.10.054.04.4
SNGN 09 04 .. T 	SNGN 09 04 12 T 00520	SH 2	36.10.050.03.7
		SH 4	19.10.050.03.7
		SL 500	36.10.050.03.0
		SL 506	19.10.050.03.1
	SNGN 09 04 08 T 02020	SH 2	36.10.049.04.7
		SN 60	36.10.049.04.5
	SNGN 09 04 12 T 02020	SH 4	19.10.050.04.7
		SL 500	36.10.050.04.0
		SL 506	19.10.050.04.1
		SN 60	36.10.050.04.5
		SN 80 E	36.10.050.04.4
	SNGN 09 04 16 T 02020	SL 500	36.10.052.04.0
		SL 506	19.10.052.04.1
	SN 60	36.10.052.04.5	
SNGN 09 04 08 . - 85Z025 	SNGN 09 04 08 F - 85Z025	SL 500	36.10.335.06.0
		SL 506	19.10.335.06.1
	SNGN 09 04 08 T 05010 - 85Z025	SN 60	36.10.335.16.5
SNGN 09 04 08 . - 85Z050 	SNGN 09 04 08 F - 85Z050	SL 500	36.10.346.06.0
		SL 506	19.10.346.06.1
	SNGN 09 04 08 T 05010 - 85Z050	SN 60	36.10.346.16.5

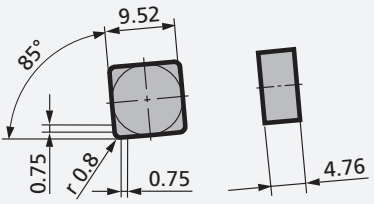
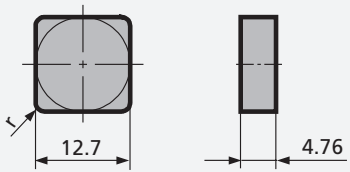
INSERT	ISO	GRADE	SPK REF. NO.
SNGN 09 04 08 T - 85Z075 	SNGN 09 04 08 T 05010 - 85Z075	SN 60	36.10.419.16.5
SNGN 12 04 .. T 	SNGN 12 04 08 T 00520	SH 2	36.10.009.03.7
		SN 60	36.10.009.03.5
	SNGN 12 04 12 T 00520	SH 2	36.10.058.03.7
		SN 60	36.10.058.03.5
	SNGN 12 04 16 T 00520	SH 2	36.10.059.03.7
		SN 60	36.10.059.03.5
	SNGN 12 04 04 T 02020	SN 60	36.10.057.04.5
	SNGN 12 04 08 T 02020	SH 2	36.10.009.04.7
		SH 4	19.10.009.04.7
		SL 500	36.10.009.04.0
		SL 506	19.10.009.04.1
		SN 60	36.10.009.04.5
	SNGN 12 04 12 T 02020	SH 2	36.10.058.04.7
		SH 4	19.10.058.04.7
		SL 500	36.10.058.04.0
		SL 506	19.10.058.04.1
		SL 550 C	17.10.058.04.3
		SN 60	36.10.058.04.5
	SNGN 12 04 16 T 02020	SN 60	36.10.059.03.5
		SH 2	36.10.059.04.7
	SL 500	36.10.059.04.0	
	SL 506	19.10.059.04.1	
	SN 60	36.10.059.04.5	

Ceramic Inserts for Turning

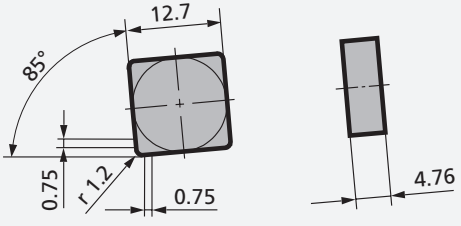
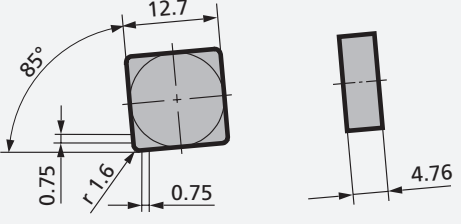
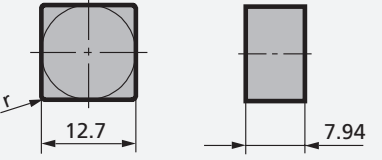
INSERT	ISO	GRADE	SPK REF. NO.
SNGN 12 04 12 T - 85Z075 	SNGN 12 04 12 T 00520 - 85Z075	SL 500	36.10.417.03.0
		SL 506	19.10.417.03.1
	SNGN 12 04 12 T 05010 - 85Z075	SN 60	36.10.417.16.5
SNGN 12 04 16 T - 85Z075 	SNGN 12 04 16 T 00520 - 85Z075	SL 500	36.10.418.03.0
		SL 506	19.10.418.03.1
SNGN 12 07 .. T 	SNGN 12 07 08 T 00520	SH 2	36.10.021.03.7
	SNGN 12 07 12 T 00520	SH 2	36.10.022.03.7
		SN 60	36.10.022.03.5
	SNGN 12 07 25 T 00520	SN 60	36.10.069.03.5
	SNGN 12 07 04 T 02020	SH 2	36.10.017.04.7
		SN 60	36.10.017.04.5
	SNGN 12 07 08 T 02020	SH 2	36.10.021.04.7
		SH 4	19.10.021.04.7
		SL 500	36.10.021.04.0
		SL 506	19.10.021.04.1
		SN 180	13.10.021.04.7
		SN 60	36.10.021.04.5
		SN 80 E	36.10.021.04.4
	SNGN 12 07 12 T 02020	SH 2	36.10.022.04.7
		SH 4	19.10.022.04.7
		SL 500	36.10.022.04.0
		SL 506	19.10.022.04.1
		SL 550 C	17.10.022.04.3
		SN 180	13.10.022.04.7
		SN 60	36.10.022.04.5
	SN 80 E	36.10.022.04.4	

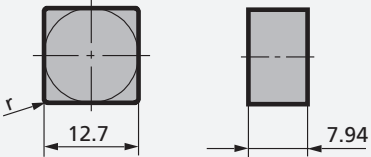
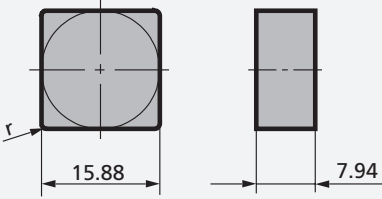
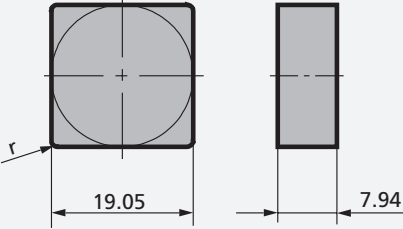
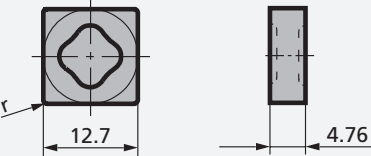
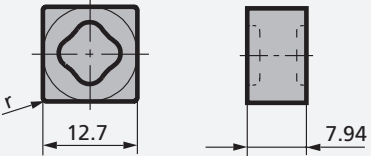
INSERT	ISO	GRADE	SPK REF. NO.
SNGN 12 07 .. T 	SNGN 12 07 16 T 02020	SH 2	36.10.023.04.7
		SH 4	19.10.023.04.7
		SL 500	36.10.023.04.0
		SL 506	19.10.023.04.1
		SL 550 C	17.10.023.04.3
		SN 180	13.10.023.04.7
		SN 60	36.10.023.04.5
		SN 80 E	36.10.023.04.4
SNGN 15 07 .. T 	SNGN 15 07 12 T 02020	SN 180	13.10.041.04.7
		SN 60	36.10.041.04.5
		SN 80 E	36.10.041.04.4
	SNGN 15 07 16 T 02020	SH 2	36.10.042.04.7
		SN 60	36.10.042.04.5
		SN 80 E	36.10.042.04.4
	SNGN 15 07 20 T 02020	SH 2	36.10.111.04.7
		SN 60	36.10.111.04.5
		SN 80 E	36.10.111.04.4
SNGN 19 07 .. 	SNGN 19 07 20 P 85	SH 2	36.10.101.85.7
	SNGN 19 07 20 S 20015	SH 2	36.10.101.27.7
	SNGN 19 07 20 T 02020	SH 2	36.10.101.04.7
SNGX 12 04 .. T 	SNGX 12 04 08 T 02020	SL 500	36.10.304.04.0
	SNGX 12 04 12 T 02020	SL 500	36.10.305.04.0
	SNGX 12 04 16 T 02020	SL 500	36.10.306.04.0
SNGX 12 07 .. T 	SNGX 12 07 08 T 02020	SH 2	36.14.168.04.7
	SNGX 12 07 12 T 02020	SH 2	36.14.169.04.7
	SNGX 12 07 16 T 02020	SH 2	36.14.170.04.7

Ceramic Inserts for Turning

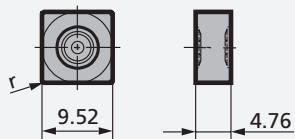
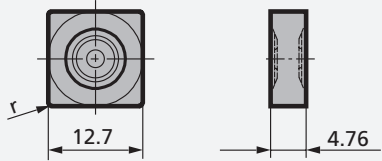
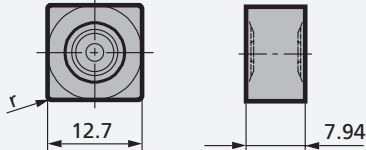
INSERT	ISO	GRADE	SPK REF. NO.
SNGX 09 04 .. T - DO 	SNGX 09 04 12 T 02020 - DO	SH 4	19.10.471.04.7
SNGX 12 04 .. T - DO 	SNGX 12 04 08 T 02020 - DO	SH 4	19.10.304.04.7
	SNGX 12 04 12 T 02020 - DO	SH 4	19.10.305.04.7
		SL 606	19.10.305.04.8
SNGX 12 07 .. T - DO 	SNGX 12 07 08 T 02020 - DO	SH 4	19.10.161.04.7
		SL 506	19.10.161.04.1
		SL 508	19.10.161.04.2
	SNGX 12 07 12 T 02020 - DO	SH 4	19.10.162.04.7
		SL 506	19.10.162.04.1
		SL 508	19.10.162.04.2
		SL 606	19.10.162.04.8
		SL 608	19.10.162.04.3
		SL 654 C	19.10.162.04.5
		SL 658 C	21.10.162.04.0
		SN 180	13.10.162.04.7
	SNGX 12 07 16 T 02020 - DO	SH 4	19.10.163.04.7
		SL 506	19.10.163.04.1
		SL 508	19.10.163.04.2
		SL 606	19.10.163.04.8
		SL 608	19.10.163.04.3
	SL 654 C	19.10.163.04.5	
	SL 658 C	21.10.163.04.0	
	SN 180	13.10.163.04.7	

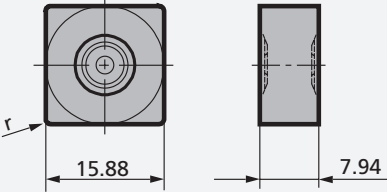
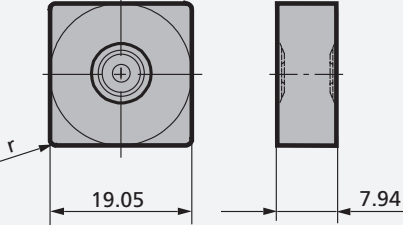
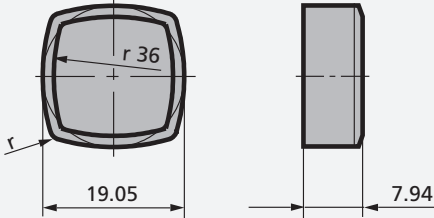
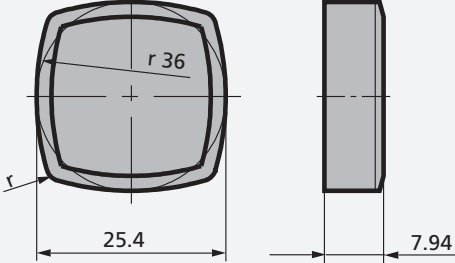
INSERT	ISO	GRADE	SPK REF. NO.
SNGX 15 07 .. T - DO 	SNGX 15 07 12 T 02020 - DO	SL 508	19.10.131.04.2
	SNGX 15 07 16 T 02020 - DO	SL 508	19.10.132.04.2
		SL 606	19.10.132.04.8
		SL 608	19.10.132.04.3
		SL 658 C	21.10.132.04.0
SNGX 19 07 .. T - DO 	SNGX 19 07 16 T 02020 - DO	SL 658 C	21.10.462.04.0
SNGX 19 07 .. S 	SNGX 19 07 20 S 20015	SH 2	36.10.132.26.7
SNGX 25 07 .. S 	SNGX 25 07 20 S 20015	SH 2	36.71.127.26.7

Ceramic Inserts for Turning

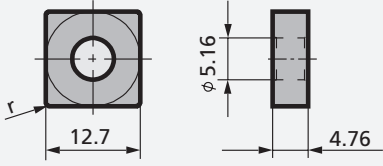
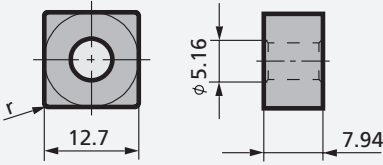
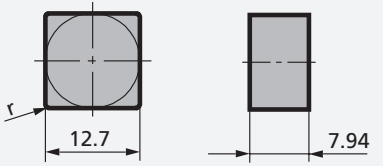
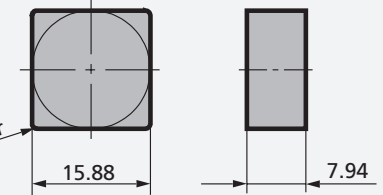
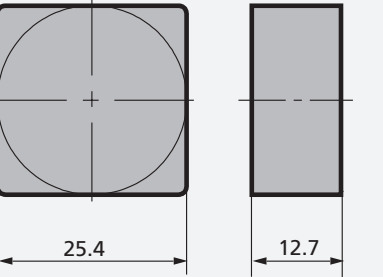
INSERT	ISO	GRADE	SPK REF. NO.
SNMA 12 04 .. T 	SNMA 12 04 08 T 02020	SL 500	36.16.046.04.0
	SNMA 12 04 12 T 02020	SL 500	36.16.047.04.0
	SNMA 12 04 16 T 02020	SL 500	36.16.048.04.0
SNMA 12 07 .. T 	SNMA 12 07 16 T 02020	SN 80 E	36.16.033.04.4
SNMN 12 07 .. T 	SNMN 12 07 08 T 02020	SN 60	36.14.002.04.5
	SNMN 12 07 12 T 02020	SN 60	36.14.003.04.5
		SN 80 E	36.14.003.04.4
	SNMN 12 07 16 T 02020	SN 60	36.14.004.04.5
		SN 80 E	36.14.004.04.4
SNMN 15 07 .. T 	SNMN 15 07 12 T 02020	SN 60	36.14.041.04.5
		SN 80 E	36.14.041.04.4
	SNMN 15 07 16 T 02020	SN 60	36.14.042.04.5
		SN 80 E	36.14.042.04.4
SNMN 25 12 .. T 	SNMN 25 12 25 T 02020	SN 80 E	36.14.032.04.4
	SNMN 25 12 25 T 03030	SN 80 E	36.14.032.54.4

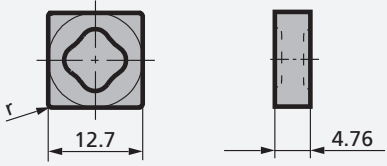
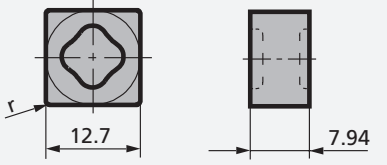
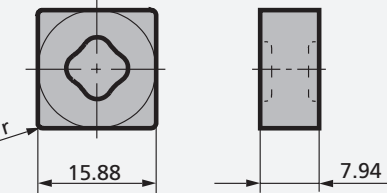
INSERT	ISO	GRADE	SPK REF. NO.
SNMX 12 04 .. T 	SNMX 12 04 12 T 02020	SL 406	13.14.270.04.3
		SL 408	13.14.270.04.3
	SNMX 12 04 16 T 02020	SL 406	13.14.271.04.3
		SL 408	13.14.271.04.3
SNMX 12 07 .. T 	SNMX 12 07 08 T 02020	SL 500	36.14.161.04.0
	SNMX 12 07 12 T 02020	SL 500	36.14.162.04.0
		SL 550 C	17.14.162.04.3
		SL 554 C	17.14.162.04.4
		SN 60	36.14.162.04.5
		SN 80 E	36.14.162.04.4
		SL 406	13.14.452.04.3
		SL 408	13.14.452.04.4
	SNMX 12 07 16 T 02020	SL 500	36.14.163.04.0
		SL 550 C	17.14.163.04.3
		SL 554 C	17.14.163.04.4
		SN 80 E	36.14.163.04.4
		SL 406	13.14.453.04.3
		SL 408	13.14.453.04.4
SNMX 15 07 .. T 	SNMX 15 07 12 T 02020	SL 500	36.14.131.04.0
		SL 550 C	17.14.131.04.3
		SL 554 C	17.14.131.04.4
		SN 80 E	36.14.131.04.4
	SNMX 15 07 16 T 02020	SL 500	36.14.132.04.0
		SL 550 C	17.14.132.04.3
		SL 554 C	17.14.132.04.4
		SN 80 E	36.14.132.04.4

Ceramic Inserts for Turning

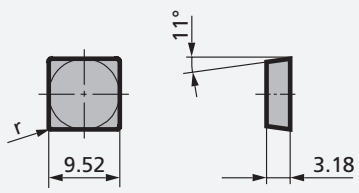
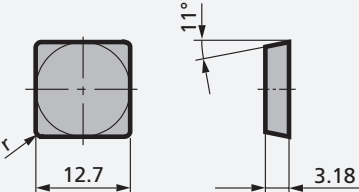
INSERT	ISO	GRADE	SPK REF. NO.	
SPUN 09 03 .. T 	SPUN 09 03 04 T 00520	SH 2	36.12.639.03.7	
		SN 60	36.12.639.03.5	
	SPUN 09 03 08 T 00520	SH 2	36.12.640.03.7	
		SN 60	36.12.640.03.5	
SPUN 12 03 .. T 	SPUN 12 03 04 T 00520	SH 2	36.12.653.03.7	
		SN 60	36.12.653.03.5	
	SPUN 12 03 08 T 00520	SH 2	36.12.654.03.7	
		SN 60	36.12.654.03.5	
	SPUN 12 03 12 T 00520	SH 2	36.12.655.03.7	
		SN 60	36.12.655.03.5	

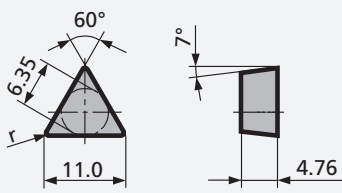
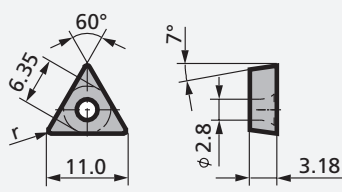
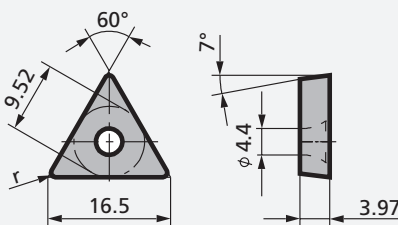
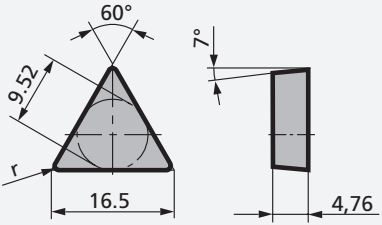
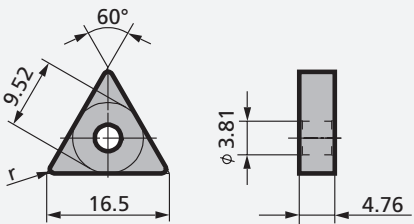
INSERT	ISO	GRADE	SPK REF. NO.
TCGN 11 04 .. T 	TCGN 11 04 16 T 00520	SL 500	36.32.226.03.0
		SL 506	19.32.226.03.1
TCGW 11 03 .. T 	TCGW 11 03 04 T 01020	SL 500	36.36.115.20.0
	TCGW 11 03 08 T 01020	SL 500	36.36.116.20.0
TCGW 16 T3 .. T 	TCGW 16 T3 04 T 01020	SL 500	36.36.117.20.0
	TCGW 16 T3 08 T 01020	SL 500	36.36.118.20.0
TCUN 16 04 .. T 	TCUN 16 04 08 T 00520	SH 2	36.32.570.03.7
		SN 60	36.32.570.03.5
	TCUN 16 04 12 T 00520	SH 2	36.32.571.03.7
		SN 60	36.32.571.03.5
	TCUN 16 04 16 T 00520	SH 2	36.32.572.03.7
		SN 60	36.32.572.03.5
TNGA 16 04 .. T 	TNGA 16 04 08 T 02020	SH 2	36.36.071.04.7
	TNGA 16 04 12 T 02020	SH 2	36.36.072.04.7

Ceramic Inserts for Turning

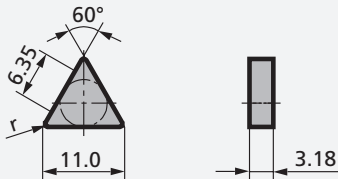
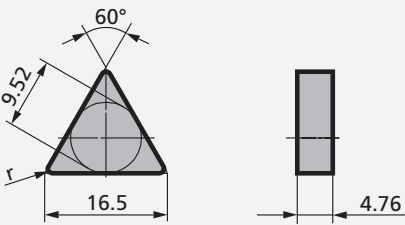
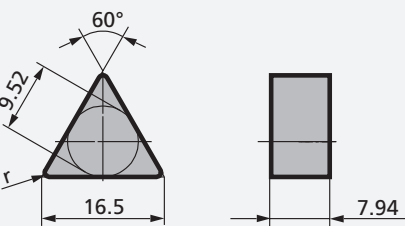
INSERT	ISO	GRADE	SPK REF. NO.
TNGN 11 03 .. T 	TNGN 11 03 08 T 00520	SH 2	36.30.013.03.7
	TNGN 11 03 12 T 00520	SH 2	36.30.033.03.7
		SN 60	36.30.033.03.5
	TNGN 11 03 08 T 02020	SH 2	36.30.013.04.7
	TNGN 11 03 12 T 02020	SH 2	36.30.033.04.7
TNGN 16 04 .. T 	TNGN 16 04 04 T 00520	SH 2	36.30.014.03.7
	TNGN 16 04 08 T 00520	SH 2	36.30.010.03.7
	TNGN 16 04 12 T 00520	SH 2	36.30.004.03.7
	TNGN 16 04 16 T 00520	SH 2	36.30.016.03.7
	TNGN 16 04 04 T 02020	SH 2	36.30.014.04.7
		SN 60	36.30.014.04.5
	TNGN 16 04 08 T 02020	SH 2	36.30.010.04.7
		SN 60	36.30.010.04.5
	TNGN 16 04 12 T 02020	SH 2	36.30.004.04.7
		SL 500	36.30.004.04.0
		SL 506	19.30.004.04.1
		SN 60	36.30.004.04.5
	TNGN 16 04 16 T 02020	SH 2	36.30.016.04.7
		SL 500	36.30.016.04.0
		SL 506	19.30.016.04.1
	SN 60	36.30.016.04.5	
TNGN 16 07 .. T 	TNGN 16 07 04 T 02020	SH 2	36.30.015.04.7
		SN 180	13.30.015.04.7
		SN 60	36.30.015.04.5
		SN 80 E	36.30.015.04.4
	TNGN 16 07 08 T 02020	SH 2	36.30.011.04.7
		SN 180	13.30.011.04.7
		SN 60	36.30.011.04.5
		SN 80 E	36.30.011.04.4
	TNGN 16 07 12 T 02020	SH 2	36.30.006.04.7
		SN 180	13.30.006.04.7
	SN 60	36.30.006.04.5	
	SN 80 E	36.30.006.04.4	

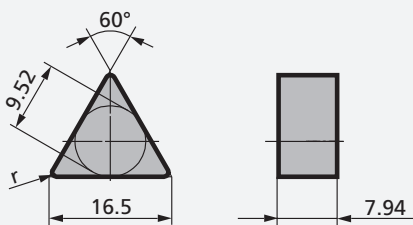
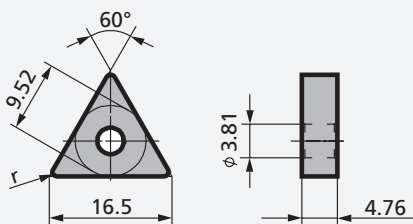
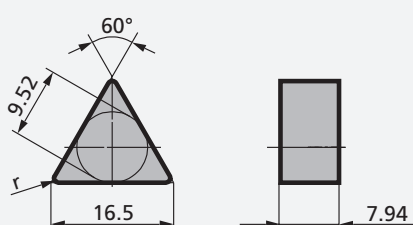
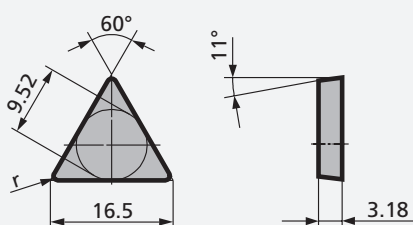
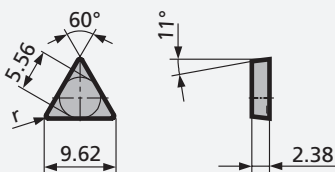
INSERT	ISO	GRADE	SPK REF. NO.
TNGN 16 07 .. T 	TNGN 16 07 16 T 02020	SH 2	36.30.017.04.7
		SN 180	13.30.017.04.7
		SN 60	36.30.017.04.5
		SN 80 E	36.30.017.04.4
TNMA 16 04 .. T 	TNMA 16 04 08 T 02020	SL 500	36.36.030.04.0
	TNMA 16 04 12 T 02020	SL 500	36.36.031.04.0
TNMN 16 07 .. T 	TNMN 16 07 08 T 02020	SN 60	36.34.051.04.5
	TNMN 16 07 12 T 02020	SN 60	36.34.052.04.5
	TNMN 16 07 16 T 02020	SN 60	36.34.053.04.5
TPGN 16 03 .. T 	TPGN 16 03 12 T 01020	SL 500	36.32.117.20.0
		SL 506	19.32.117.20.1
TPUN 09 02 .. T 	TPUN 09 02 04 T 00520	SH 2	36.32.601.03.7
	TPUN 09 02 08 T 00520	SH 2	36.32.602.03.7

Ceramic Inserts for Turning

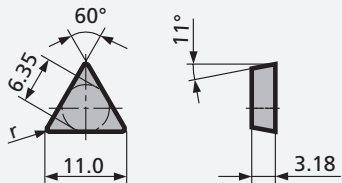
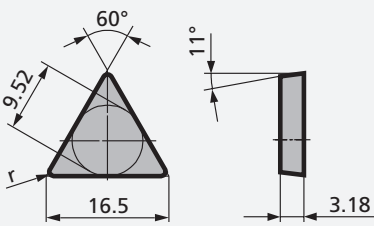
INSERT	ISO	GRADE	SPK REF. NO.	
TPUN 11 03 .. T 	TPUN 11 03 04 T 00520	SH 2	36.32.607.03.7	
		SN 60	36.32.607.03.5	
	TPUN 11 03 08 T 00520	SH 2	36.32.608.03.7	
		SL 500	36.32.608.03.0	
		SN 60	36.32.608.03.5	
	TPUN 11 03 12 T 00520	SH 2	36.32.609.03.7	
		SL 500	36.32.609.03.0	
		SL 506	19.32.609.03.1	
		SN 60	36.32.609.03.5	
	TPUN 16 03 .. T 	TPUN 16 03 04 T 00520	SH 2	36.32.615.03.7
			SN 60	36.32.615.03.5
		TPUN 16 03 08 T 00520	SH 2	36.32.616.03.7
		SL 500	36.32.616.03.0	
		SL 506	19.32.616.03.1	
		SN 60	36.32.616.03.5	
TPUN 16 03 12 T 00520		SH 2	36.32.617.03.7	
		SL 500	36.32.617.03.0	
		SL 506	19.32.617.03.1	
		SN 60	36.32.617.03.5	
TPUN 16 03 16 T 00520		SH 2	36.32.618.03.7	
		SL 500	36.32.618.03.0	
	SL 506	19.32.618.03.1		
	SN 60	36.32.618.03.5		

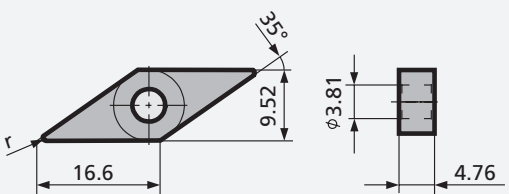
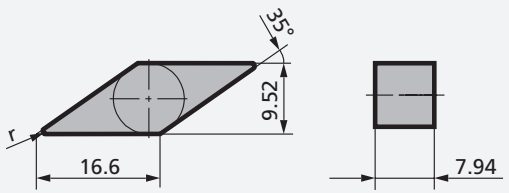
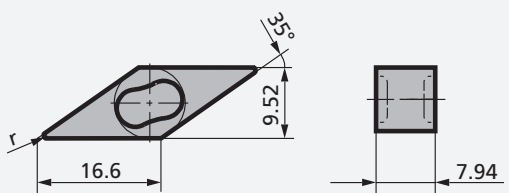
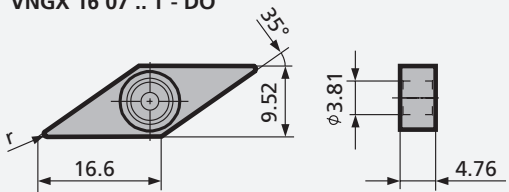
INSERT	ISO	GRADE	SPK REF. NO.
VNGA 16 04 .. T 	VNGA 16 04 04 T 02020	SH 2	36.56.246.04.7
	VNGA 16 04 08 T 02020	SH 2	36.56.247.04.7
	VNGA 16 04 12 T 02020	SH 2	36.56.248.04.7
	VNGA 16 04 16 T 02020	SH 2	36.56.249.04.7
VNGN 16 07 .. T 	VNGN 16 07 04 T 02020	SH 2	36.50.176.04.7
	VNGN 16 07 08 T 02020	SH 2	36.50.177.04.7
	VNGN 16 07 12 T 02020	SH 2	36.50.178.04.7
	VNGN 16 07 16 T 02020	SH 2	36.50.179.04.7
VNGX 16 07 .. T 	VNGX 16 07 08 T 00520	SN 80 E	36.50.235.03.4
	VNGX 16 07 12 T 00520	SL 500	36.50.236.03.0
		SN 80 E	36.50.236.03.4
		SL 500	36.50.236.04.0
		SL 550 C	17.50.236.04.3
		SN 80 E	36.50.236.04.4
	VNGX 16 07 16 T 02020	SL 500	36.50.237.04.0
	SL 550 C	17.50.237.04.3	
VNGX 16 07 .. T - DO 	VNGX 16 07 12 T 02020 - DO	SL 506	19.50.236.04.1
		SL 508	19.50.236.04.2
	VNGX 16 07 16 T 02020 - DO	SL 506	19.50.237.04.1



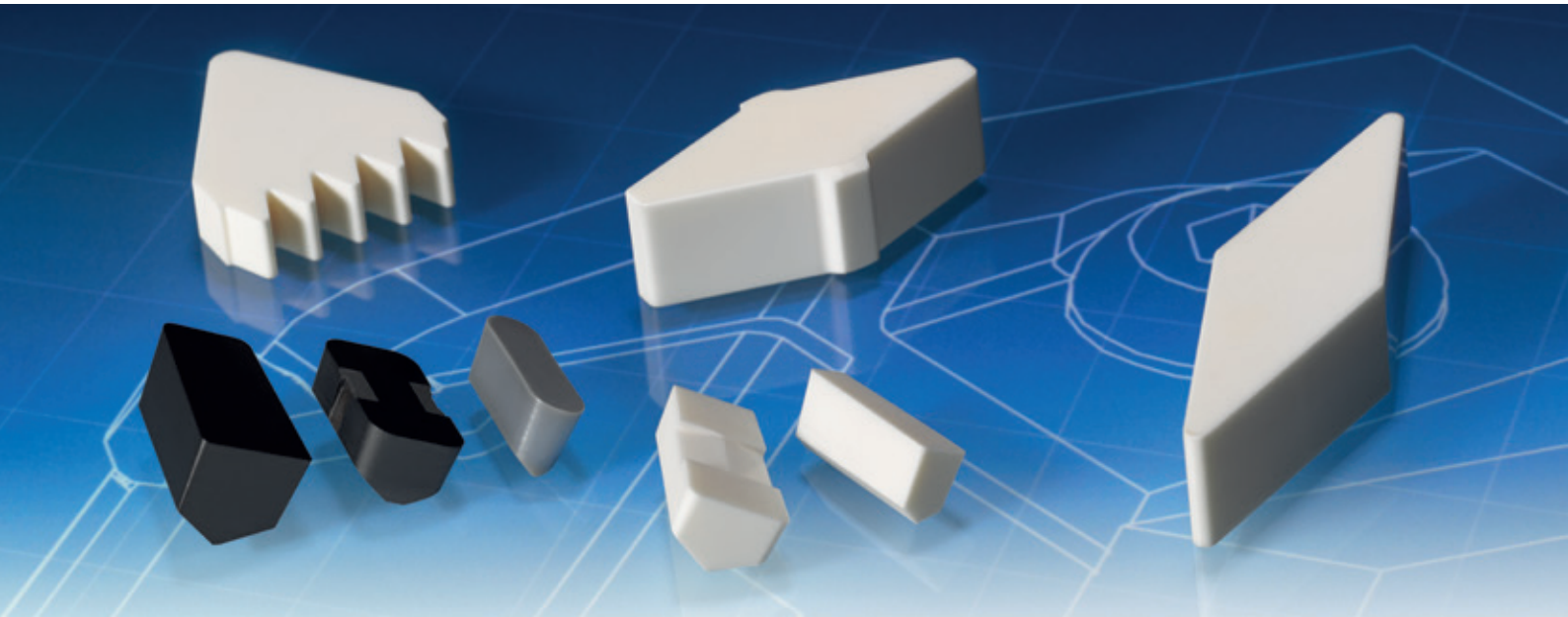







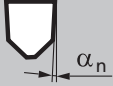

Cutting Data Recommendations for Grooving

MATERIAL	HARDNESS (HB)	CUTTING SPEED v_c (m/min)		FEED RATE f (mm)		GRADE
		RECOMMENDED VALUE	OVERALL RANGE	RECOMMENDED VALUE	OVERALL RANGE	
GREY CAST IRON	140 - 220	400	200 - 800	0.12	0.08 - 0.20	SN 60
		400	200 - 800	0.15	0.08 - 0.20	SN 80 E
		500	300 - 1000	0.15	0.08 - 0.20	SL 500
		600	300 - 1200	0.15	0.08 - 0.25	SL 608
		600	400 - 1000	0.12	0.08 - 0.20	SH 2
	230 - 280	300	150 - 600	0.10	0.08 - 0.15	SN 60
		300	150 - 600	0.10	0.08 - 0.15	SN 80 E
		400	300 - 800	0.10	0.08 - 0.15	SL 500
		600	300 - 900	0.12	0.08 - 0.20	SL 608
		500	300 - 900	0.10	0.08 - 0.16	SH 2

MATERIAL	HARDNESS (HRC)	CUTTING SPEED v_c (m/min)		FEED RATE f (mm)		GRADE
		RECOMMENDED VALUE	OVERALL RANGE	RECOMMENDED VALUE	OVERALL RANGE	
HARDENED STEEL	45 - 55	120	50 - 180	0.08	0.06 - 0.12	SH 2
	50 - 60	150	80 - 200	0.08	0.06 - 0.15	SH 4



Designation System for Grooving Inserts

G  Single-edge	 <table border="1"> <tr><td>N</td><td>0°</td></tr> <tr><td>A</td><td>3°</td></tr> <tr><td>B</td><td>5°</td></tr> <tr><td>C</td><td>7°</td></tr> <tr><td>P</td><td>11°</td></tr> <tr><td>O</td><td>Clearance angle which requires special data.</td></tr> </table>	N	0°	A	3°	B	5°	C	7°	P	11°	O	Clearance angle which requires special data.	<table border="1"> <tr><td>N</td><td></td></tr> <tr><td>P</td><td></td></tr> <tr><td>X</td><td>Special design</td></tr> </table>	N		P		X	Special design	 <table border="1"> <tr><td>A</td><td>≤ 5 mm</td></tr> <tr><td>B</td><td>≤ 5.5 mm</td></tr> <tr><td>C</td><td>≤ 6 mm</td></tr> <tr><td>D</td><td>≤ 6.5 mm</td></tr> <tr><td>E</td><td>≤ 7.5 mm</td></tr> <tr><td>F</td><td>≤ 8 mm</td></tr> <tr><td>G</td><td>≤ 10 mm</td></tr> </table>	A	≤ 5 mm	B	≤ 5.5 mm	C	≤ 6 mm	D	≤ 6.5 mm	E	≤ 7.5 mm	F	≤ 8 mm	G	≤ 10 mm
N		0°																																	
A		3°																																	
B		5°																																	
C		7°																																	
P		11°																																	
O	Clearance angle which requires special data.																																		
N																																			
P																																			
X	Special design																																		
A	≤ 5 mm																																		
B	≤ 5.5 mm																																		
C	≤ 6 mm																																		
D	≤ 6.5 mm																																		
E	≤ 7.5 mm																																		
F	≤ 8 mm																																		
G	≤ 10 mm																																		
L  Double-edge																																			
Insert shape	Normal clearance angle α_n	Insert type	Insert thickness																																
G	B	M	P	12	A																														

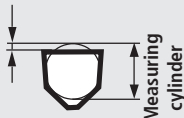
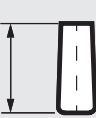
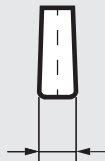
Tolerance			Insert size	
	Height	Length	Groove width	
				
M	± 0.13 mm	± 0.1 mm	12	12.0 mm
			15	15.0 mm

F 
Sharp

S 
Chamfered and rounded

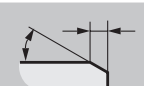
T 
Chamfered

Corner design

Left radius		Right radius	
L0.8	r=0.8mm	R0.8	r=0.8mm
L1.5	r=1.5mm	R1.5	r=1.5mm
L2	r=2.0mm	R2	r=2.0mm
..

Edge radii

0400

T

- N

L2R2

- RAG

Groove width

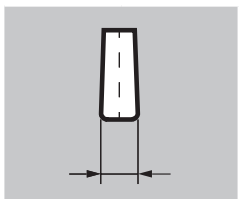

0400	4 mm
0500	5 mm
0600	6 mm
0700	7 mm
0800	8 mm
0900	9 mm
..	..

Cutting direction

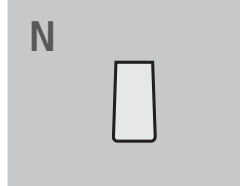
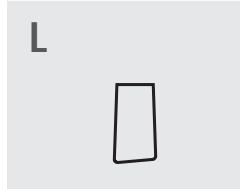
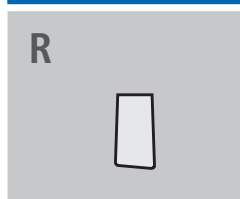

Type Grooving system

Designation System for Poly-V Grooving Inserts

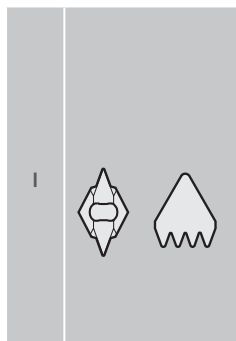

Insert shape

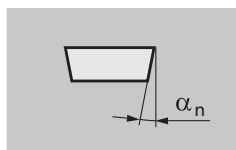

N	0°
A	3°
B	5°
C	7°
P	11°

Normal clearance angle α_n

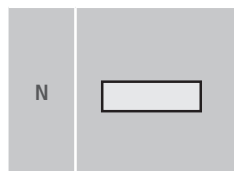

Insert type

I

N

M

N

12

Tolerances

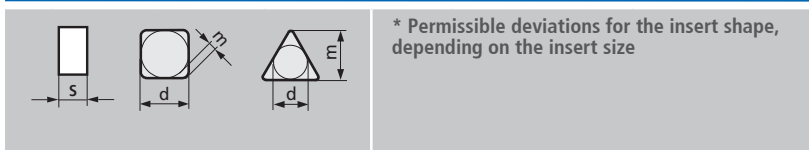

	S = ± mm	d = ± mm	m = ± mm	Inscribed circle d mm	Tolerance class			
					d mm	U	M, N	U
A	0,025	0,025	0,005	3,97	0,05	0,08	0,08	0,13
C	0,025	0,025	0,013					
E	0,025	0,025	0,025	5,56	0,08	0,13	0,13	0,2
F	0,025	0,013	0,005					
G	0,130	0,025	0,025	6,35	0,1	0,18	0,15	0,27
H	0,025	0,013	0,013					
J	0,025	0,05-0,13*	0,005	9,52	0,13	0,18	0,15	0,27
K	0,025	0,05-0,13*	0,013					
L	0,025	0,05-0,13*	0,025	15,88	0,13	0,25	0,18	0,38
M	0,130	0,05-0,13*	0,08-0,18*					
U	0,130	0,08-0,25*	0,13-0,38*	25,40				

Insert size



09	9.52 mm
12	12.70 mm
15	15.88 mm

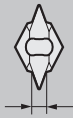

023	2.3 mm
036	3.6 mm
047	4.7 mm
094	9.4 mm



111	11.1 mm
147	14.7 mm
182	18.2 mm
218	21.8 mm

Insert width

J
K
L
M

Profile type
Poly-V profile DIN 7867

6	6 cutting edges
5	5 cutting edges
4	4 cutting edges
3	3 cutting edges
1	1 cutting edge

Number of cutting edges
Poly-V profile DIN 7867

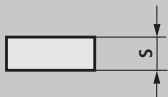

A 147 T - K 4 - 04

Insert thickness



A	≤ 5 mm
B	≤ 5.5 mm
C	≤ 6 mm
D	≤ 6.5 mm
E	≤ 7.5 mm
F	≤ 8 mm
G	≤ 10 mm

Corner design

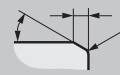
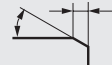
E	
F	
S	
T	













Radius Tooth interior



04	0.4 mm
----	--------



Contents: Ceramic Inserts for Grooving

GBMP - RAG	LBMP - RAG	GBMP	GBMP TL, GBMP TR
			
Page 62	Page 63	Page 64-65	Page 65
LBMP	NBMN	Poly-V profile INMX	Poly-V profile INMN
			
Page 66-67	Page 68	Page 69	Page 70-71
Profile KP1	Profile KP2	Profile P1	Profile P2
			
Page 72	Page 73	Page 74	Page 75

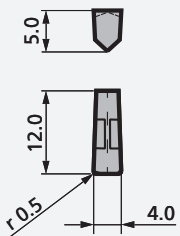
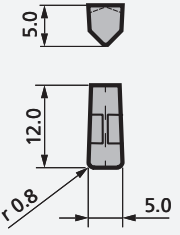
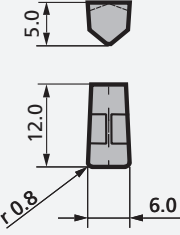
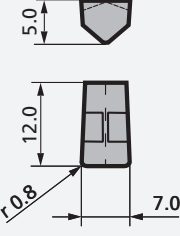
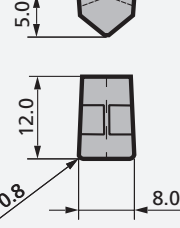
INSERT	DESIGNATION	GRADE	SPK REF. NO.
GBMP 12 A 0400 - RAG 	GBMP 12 A 0400 T00520 - N L0.5R0.5 - RAG	SH 2	36.23.505.03.7
		SL 500	36.23.505.03.0
		SL 608	19.23.505.03.3
		SN 60	36.23.505.03.5
GBMP 12 A 0500 - RAG 	GBMP 12 A 0500 T00520 - N L0.8R0.8 - RAG	SH 2	36.23.506.03.7
		SL 500	36.23.506.03.0
		SL 608	19.23.506.03.3
		SN 60	36.23.506.03.5
GBMP 12 A 0600 - RAG 	GBMP 12 A 0600 T00520 - N L0.8R0.8 - RAG	SH 2	36.23.507.03.7
		SL 500	36.23.507.03.0
		SL 608	19.23.507.03.3
		SN 60	36.23.507.03.5
GBMP 12 A 0700 - RAG 	GBMP 12 A 0700 T00520 - N L0.8R0.8 - RAG	SH 2	36.23.508.03.7
		SL 500	36.23.508.03.0
		SL 608	19.23.508.03.3
		SN 60	36.23.508.03.5
GBMP 12 A 0800 - RAG 	GBMP 12 A 0800 T00520 - N L0.8R0.8 - RAG	SH 2	36.23.509.03.7
		SL 500	36.23.509.03.0
		SL 608	19.23.509.03.3
		SN 60	36.23.509.03.5

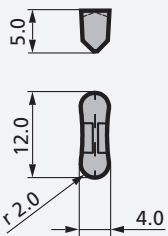
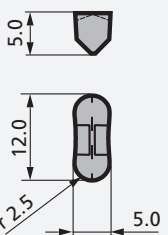
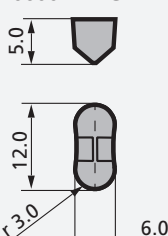
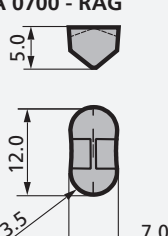
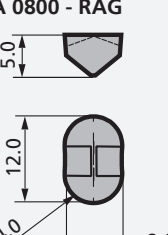
INSERT	DESIGNATION	GRADE	SPK REF. NO.
LBMP 12 A 0400 - RAG 	LBMP 12 A 0400 T00520 - N L2R2 - RAG	SH 2	36.23.500.03.7
		SL 500	36.23.500.03.0
		SL 608	19.23.500.03.3
		SN 60	36.23.500.03.5
LBMP 12 A 0500 - RAG 	LBMP 12 A 0500 T00520 - N L2.5R2.5 - RAG	SH 2	36.23.501.03.7
		SL 500	36.23.501.03.0
		SL 608	19.23.501.03.3
		SN 60	36.23.501.03.5
LBMP 12 A 0600 - RAG 	LBMP 12 A 0600 T00520 - N L3R3 - RAG	SH 2	36.23.502.03.7
		SL 500	36.23.502.03.0
		SL 608	19.23.502.03.3
		SN 60	36.23.502.03.5
LBMP 12 A 0700 - RAG 	LBMP 12 A 0700 T00520 - N L3.5R3.5 - RAG	SH 2	36.23.503.03.7
		SL 500	36.23.503.03.0
		SL 608	19.23.503.03.3
		SN 60	36.23.503.03.5
LBMP 12 A 0800 - RAG 	LBMP 12 A 0800 T00520 - N L4R4 - RAG	SH 2	36.23.504.03.7
		SL 500	36.23.504.03.0
		SL 608	19.23.504.03.3
		SN 60	36.23.504.03.5

Ceramic Inserts for Grooving

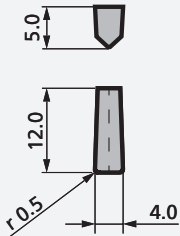
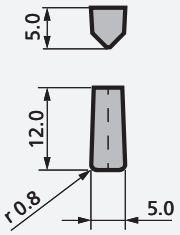
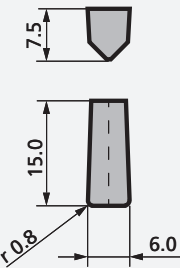
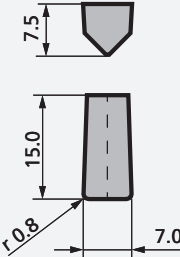
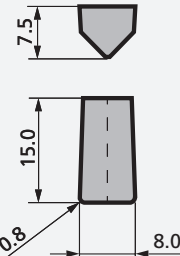
INSERT	DESIGNATION	GRADE	SPK REF. NO.
GBMP 12 A 040 	GBMP 12 A 040 S 05015	SH 2	36.22.100.31.7
	GBMP 12 A 040 T 00520	SH 2	36.22.100.03.7
		SL 500	36.22.100.03.0
		SN 60	36.22.100.03.5
GBMP 12 A 050 	GBMP 12 A 050 S 05015	SH 2	36.22.101.31.7
	GBMP 12 A 050 T 00520	SH 2	36.22.101.03.7
		SL 500	36.22.101.03.0
		SN 60	36.22.101.03.5
GBMP 15 E 060 	GBMP 15 E 060 S 05015	SH 2	36.70.768.31.7
	GBMP 15 E 060 T 00520	SH 2	36.70.768.03.7
		SL 500	36.70.768.03.0
		SN 60	36.70.768.03.5
		SN 80 E	36.70.768.03.4
GBMP 15 E 070 	GBMP 15 E 070 T 00520	SH 2	36.70.769.03.7
		SL 500	36.70.769.03.0
		SN 60	36.70.769.03.5
		SN 80 E	36.70.769.03.4
GBMP 15 E 080 	GBMP 15 E 080 T 00520	SH 2	36.70.770.03.7
		SL 500	36.70.770.03.0
		SN 60	36.70.770.03.5
		SN 80 E	36.70.770.03.4

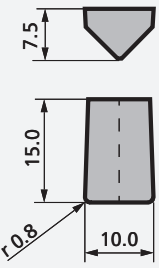
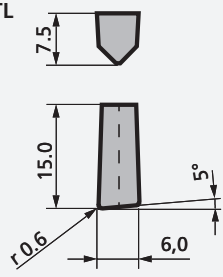
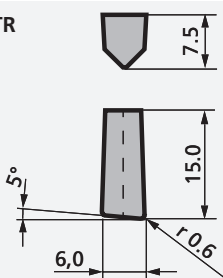
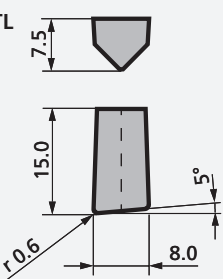
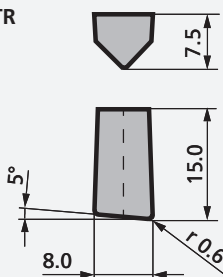
INSERT	DESIGNATION	GRADE	SPK REF. NO.
GBMP 15 E 100 	GBMP 15 E 100 T 00520	SH 2	36.70.900.03.7
		SL 500	36.70.900.03.0
		SN 60	36.70.900.03.5
		SN 80 E	36.70.900.03.4
GBMP 15 E 060 TL 	GBMP 15 E 060 TL 00520	SN 60	36.70.786.03.5
GBMP 15 E 060 TR 	GBMP 15 E 060 TR 00520	SN 60	36.70.787.03.5
GBMP 15 E 080 TL 	GBMP 15 E 080 TL 00520	SN 60	36.70.651.03.5
GBMP 15 E 080 TR 	GBMP 15 E 080 TR 00520	SN 60	36.70.661.03.5

Ceramic Inserts for Grooving

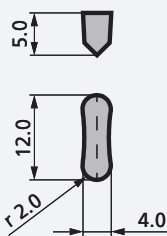
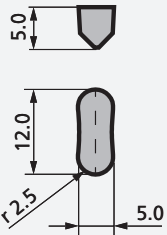
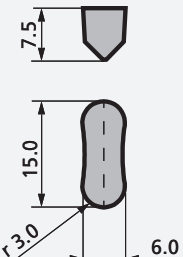
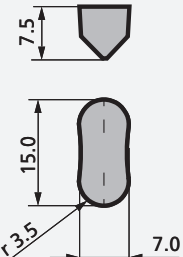
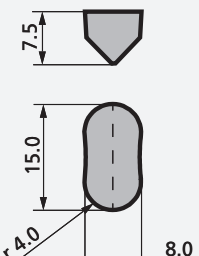
INSERT	DESIGNATION	GRADE	SPK REF. NO.
LBMP 12 A 040 	LBMP 12 A 040 S 05015	SH 2	36.22.107.31.7
	LBMP 12 A 040 T 00520	SH 2	36.22.107.03.7
		SL 500	36.22.107.03.0
		SN 60	36.22.107.03.5
LBMP 12 A 050 	LBMP 12 A 050 S 05015	SH 2	36.22.108.31.7
	LBMP 12 A 050 T 00520	SH 2	36.22.108.03.7
		SL 500	36.22.108.03.0
		SN 60	36.22.108.03.5
LBMP 15 E 060 	LBMP 15 E 060 S 05015	SH 2	36.70.903.31.7
	LBMP 15 E 060 T 00520	SH 2	36.70.903.03.7
		SL 500	36.70.903.03.0
		SN 60	36.70.903.03.5
LBMP 15 E 070 	LBMP 15 E 070 T 00520	SL 500	36.70.872.03.0
		SN 60	36.70.872.03.5
LBMP 15 E 080 	LBMP 15 E 080 T 00520	SL 500	36.70.825.03.0
		SN 60	36.70.825.03.5

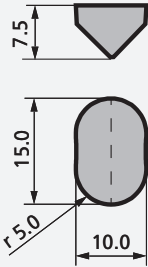
INSERT	DESIGNATION	GRADE	SPK REF. NO.
LBMP 15 E 100 	LBMP 15 E 100 T 00520	SN 60	36.70.904.03.5
		SL 500	36.70.904.03.0
	LBMP 15 E 100 T 02020	SL 500	36.70.904.04.0

Ceramic Inserts for Grooving

INSERT	DESIGNATION	GRADE	SPK REF. NO.
NBMN 12 F 100 	NBMN 12 F 100 T 02020	SH 2	36.22.267.04.7
		SN 80 E	36.22.267.04.4
NBMN 12 F 120 	NBMN 12 F 120 T 02020	SH 2	36.22.268.04.7
		SN 80 E	36.22.268.04.4
NBMN 15 F 150 	NBMN 15 F 150 T 02020	SH 2	36.22.269.04.7
		SN 80 E	36.22.269.04.4
NBMN 19 F 190 	NBMN 19 F 190 T 02020	SH 2	36.22.270.04.7
		SN 80 E	36.22.270.04.4
NBMN 24 F 250 	NBMN 24 F 250 T 02020	SH 2	36.22.271.04.7
		SN 80 E	36.22.271.04.4

INSERT	DESIGNATION	GRADE	SPK REF. NO.
INMX 25 F 023 - J1 	INMX 25 F 023 T 00520 - J1	SN 60	36.71.419.03.5
INMX 25 F 036 - K1 	INMX 25 F 036 T 00520 - K1	SN 60	36.71.412.03.5
INMX 25 F 047 - L1 	INMX 25 F 047 T 00520 - L1	SN 60	36.71.340.03.5
INMX 25 F 094 - M1 	INMX 25 F 094 T 00520 - M1	SN 60	36.71.418.03.5

Ceramic Inserts for Grooving

INSERT	DESIGNATION	GRADE	SPK REF. NO.
INMN 09 A 111 - K3 	INMN 09 A 111 F - K3	SN 60	36.71.454.06.5
INMN 09 A 111 - K3-04 	INMN 09 A 111 E - K3-04	SN 60	36.71.501.69.5
INMN 12 A 147 - K4 	INMN 12 A 147 F - K4	SN 60	36.71.455.06.5
INMN 12 A 147 - K4-04 	INMN 12 A 147 E - K4-04	SN 60	36.71.502.69.5
INMN 15 A 182 - K5 	INMN 15 A 182 E - K5	SN 60	36.71.507.69.5

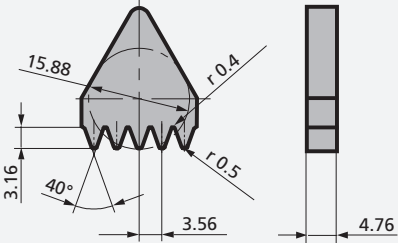
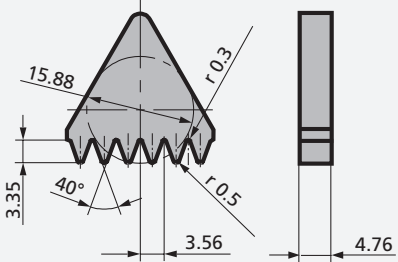
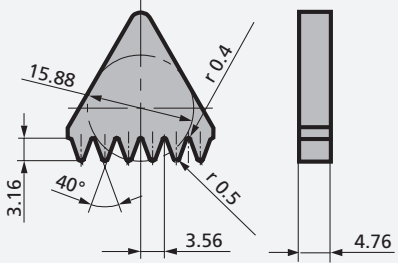
INSERT	DESIGNATION	GRADE	SPK REF. NO.
<p>INMN 15 A 182 - K5-04</p> 	INMN 15 A 182 E - K5-04	SN 60	36.71.519.69.5
<p>INMN 15 A 218 - K6</p> 	INMN 15 A 218 E - K6	SN 60	36.71.508.69.5
<p>INMN 15 A 218 - K6-04</p> 	INMN 15 A 218 E - K6-04	SN 60	36.71.520.69.5

Ceramic Inserts for Grooving

Profile KP 1

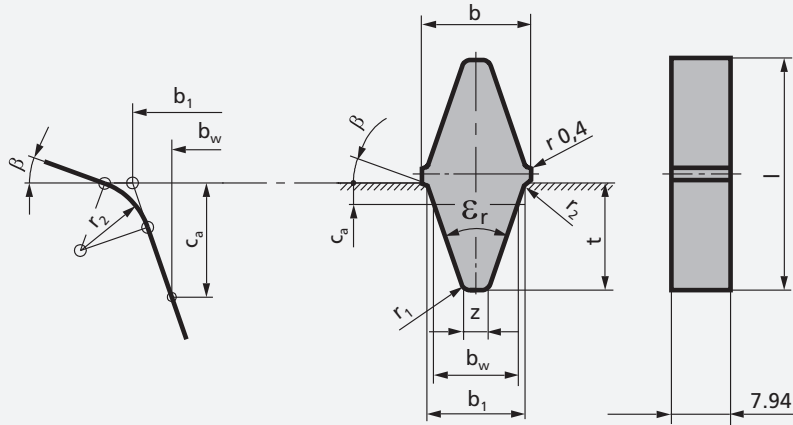

INSERT	GRADE	SPK REF. NO.	Dimensions (mm)										
			b _w	b ₁	t	c _a	b	l	t	β	r ₁	r ₂	
KP1 - 34° SPA	DIN 2211	SN 60	36.71.258.04.5	11.0	12.7	14.0	2.8	14.5	32.0	4.14	20°	1.0	1.0
KP1 - 34° SPB	DIN 2211	SN 60	36.71.259.04.5	14.0	16.3	18.0	3.5	18.5	40.0	5.29	20°	1.5	1.0
KP1 - 34° SPC	DIN 2211	SN 60	36.71.260.04.5	19.0	22.0	24.0	4.8	24.5	52.0	7.32	20°	2.0	1.0
KP1 - 34° SPZ	DIN 2211	SN 60	36.71.257.04.5	8.5	9.7	11.0	2.0	11.5	26.0	2.97	20°	1.0	1.0
KP1 - 36°		SN 60	36.71.169.04.5	9.75	10.20	11.9	0.75	12.50	27.3	2.40	20°	0.8	0.8
KP1 - 36°		SN 60	36.71.190.04.5	9.70	10.34	12.0	1.0	13.35	28.0	2.55	20°	1.0	1.6
KP1 - 36°		SN 60	36.71.195.04.5	12.70	13.60	15.5	1.50	17.00	35.0	3.60	20°	1.0	1.5
KP1 - 36°		SN 60	36.71.275.04.5	-	10.80	13.2	-	14.00	31.0	2.20	20°	0.5	1.5
KP1 - 38° SPA	DIN 2211	SN 60	36.71.262.04.5	11.0	12.9	14.3	2.8	14.5	32.0	3.06	20°	1.0	1.0
KP1 - 38° SPB	DIN 2211	SN 60	36.71.263.04.5	14.0	16.3	18.0	3.5	18.5	40.0	3.90	20°	1.5	1.0
KP1 - 38° SPC	DIN 2211	SN 60	36.71.264.04.5	19.0	22.0	24.0	4.8	24.5	52.0	5.47	20°	2.0	1.0
KP1 - 38° SPZ	DIN 2211	SN 60	36.71.214.04.5	8.5	9.7	11.0	2.0	11.5	25.5	2.17	20°	1.0	1.0
KP1 - 38°		SN 60	36.71.215.04.5	11.0	12.7	13.0	2.50	16.0	29.5	3.72	20°	1.0	1.0
KP1 - 38°		SN 60	36.71.246.04.5	12.86	12.9	14.8	-	16.5	34.0	2.69	20°	1.5	1.0

Profile KP 2

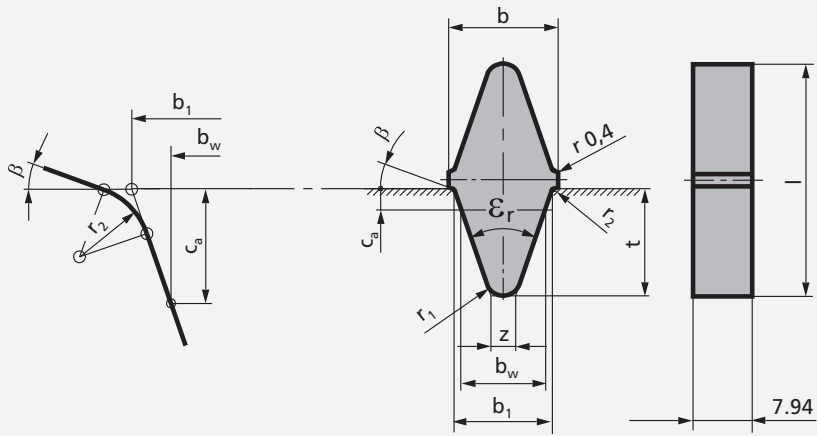

INSERT	GRADE	SPK REF. NO.	Dimensions (mm)									
			b_w	b_1	t	c_a	b	l	t	β	r_1	r_2
KP2 - 36°	SN 60	36.71.192.04.5	12.7	13.3	15.5	1.0	16.3	35.0	3.24	30°	2.2	1.6

Ceramic Inserts for Grooving

Profile P 1

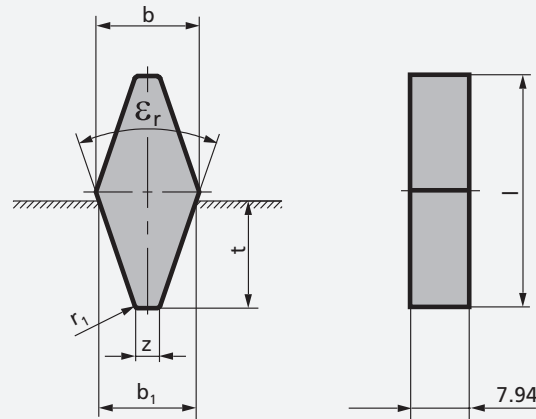

INSERT	GRADE	SPK REF. NO.	Dimensions (mm)					
			b _w	t	b	l	z	r ₁
P1 - 30°	Sn 60	36.70.750.04.5	16,0	21,0	17,07	46,0	4,75	1,0
P1 - 34° SPA DIN 2211	SN 60	36.70.697.04.5	12,7	14,0	13,82	32,0	4,04	1,0
P1 - 34° SPB DIN 2211	SN 60	36.70.714.04.5	16,3	18,0	17,52	40,0	5,29	1,5
P1 - 34° SPC DIN 2211	SN 60	36.70.716.04.5	22,0	24,0	23,22	52,0	7,32	2,0
P1 - 34° SPZ DIN 2211	SN 60	36.70.699.04.5	9,7	11,0	10,92	26,0	2,97	1,0
P1 - 34°	SN 60	36.70.620.04.5	17,0	16,0	18,22	36,0	7,22	1,5
P1 - 34°	SN 60	36.70.669.04.5	13,0	15,0	14,22	34,0	3,83	1,0
P1 - 34°	SN 60	36.70.718.04.5	18,6	20,0	19,82	44,0	6,37	2,0
P1 - 34°	SN 60	36.70.735.04.5	10,0	12,0	11,22	28,0	2,66	1,0
P1 - 34°	SN 60	36.70.739.04.5	17,0	18,0	18,22	40,0	5,99	1,5
P1 - 36°	SN 60	36.70.418.04.5	12,7	14,0	16,6	40	3,60	1,0
P1 - 36°	SN 60	36.70.710.04.5	9,7	11,5	11,0	27	2,22	0,5
P1 - 36°	SN 60	36.70.726.04.5	22,0	20,5	23,3	45	8,68	1,5
P1 - 36°	SN 60	36.70.738.04.5	13,0	15,0	14,3	34	3,25	1,0
P1 - 38° SPA DIN 2211	SN 60	36.70.698.04.5	12,7	14,0	14,08	32,0	3,06	1,0
P1 - 38° SPB DIN 2211	SN 60	36.70.715.04.5	16,3	18,0	17,68	40,0	3,91	1,5
P1 - 38° SPC DIN 2211	SN 60	36.70.717.04.5	22,0	24,0	23,38	52,0	5,47	2,0
P1 - 38° SPZ DIN 2211	SN 60	36.70.700.04.5	9,7	11,0	11,07	26,0	2,12	1,0
P1 - 38°	SN 60	36.70.492.04.5	13,3	13,00	14,68	30,0	4,35	1,0
P1 - 38°	SN 60	36.70.610.04.5	14,5	16,50	15,86	37,0	3,12	1,0
P1 - 38°	SN 60	36.70.621.04.5	17,0	16,00	18,38	36,0	5,98	1,0
P1 - 38°	SN 60	36.70.709.04.5	12,6	14,75	14,04	33,5	2,51	0,5
P1 - 38°	SN 60	36.70.719.04.5	18,6	20,00	19,98	44,0	4,83	2,0
P1 - 38°	SN 60	36.70.833.04.5	15,7	17,50	17,10	39,0	3,66	0,8
P1 - 40°	SN 60	36.70.795.04.5	15,2	15,2	16,69	34,5	4,14	0,5

Profile P 2

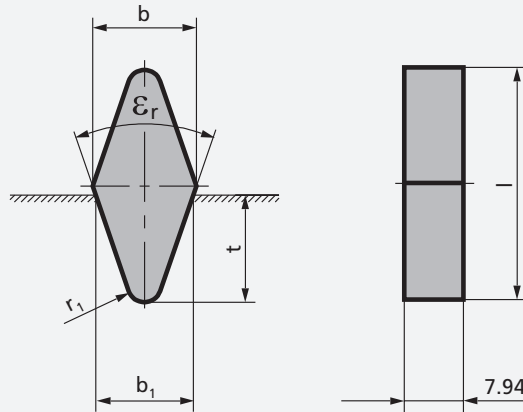

INSERT	GRADE	SPK REF. NO.	Dimensions (mm)				
			b ₁	t	b	l	r ₁
P2 - 30°	SN 60	36.70.638.04.5	10.5	15.0	11.56	34.0	1.6
P2 - 30°	SN 60	36.70.729.04.5	10.5	17.5	11.56	38.5	0.8
P2 - 36°	SN 60	36.70.493.04.5	9.8	11.5	11.1	27.0	1.8
P2 - 36°	SN 60	36.70.630.04.5	13.8	18.0	15.2	40.0	1.5
P2 - 36°	SN 60	36.70.832.04.5	13.0	15.5	14.3	35.0	2.0













Cutting Data Recommendations for Milling Grey Cast Iron

MATERIAL NO.	HARDNESS (HB)	D	EU	F	GB	S	E	I	USA	J
		DIN	EN	AFNOR	B.S.	SS	UNE	UNI	AISI/SAE	JIS
0.6015	190	GG-15	GJL-150	Ft 15 D	Grade 150	0115-00	FG 15	G 15	No 25 B	FC 150
0.6020	210	GG-20	GJL-200	Ft 20 D	Grade 220	0120-00		G 20	No 30 B	FC 200
0.6025	240	GG-25	GJL-250	Ft 25 D	Grade 260	0125-00	FG 25	G 25	No 35 B	FC 250
0.6030	260	GG-30	GJL-300	Ft 30 D	Grade 300	0130-00	FG 30	G 30	No 45 B	FC 300
0.6035	280	GG-35	GJL-350	Ft 35 D	Grade 350	0135-00	FG 35	G 35	No 50 B	FC 350

Cutting speed and feed rate

HARDNESS (HB)	CUTTING SPEED V_c (m/min)		FEED RATE f_z (mm/t)			GRADE	
	RECOMMENDED VALUE	OVERALL RANGE	RECOMMENDED VALUE	OVERALL RANGE			
				$K_r = 45^\circ$	$K_r = 75^\circ$		$K_r = 88^\circ/90^\circ$
12.5/√ Rough milling · $a_p < 5$ mm							
190 - 210	1500	800 - 2000	0.16	0.12 - 0.30	0.10 - 0.20	0.08 - 0.20	SL 808
	1600	800 - 2000	0.16	0.12 - 0.30	0.10 - 0.20	0.08 - 0.20	SL 858 C
220 - 240	1200	500 - 1500	0.16	0.12 - 0.30	0.10 - 0.20	0.08 - 0.20	SL 808
	1200	500 - 1500	0.16	0.12 - 0.30	0.10 - 0.20	0.08 - 0.20	SL 858 C
250 - 280	800	300 - 1200	0.16	0.12 - 0.30	0.10 - 0.20	0.08 - 0.20	SL 808
	800	300 - 1200	0.16	0.12 - 0.30	0.10 - 0.20	0.08 - 0.20	SL 858 C
6.3/√ Rough milling · $a_p < 2$ mm							
190 - 210	1500	800 - 2000	0.16	0.12 - 0.30	0.10 - 0.20	0.08 - 0.20	SL 500
	1500	800 - 2000	0.16	0.12 - 0.30	0.10 - 0.20	0.08 - 0.20	SL 854 C
	1500	800 - 2000	0.16	0.12 - 0.30	0.10 - 0.20	0.08 - 0.20	SL 858 C
220 - 240	1200	500 - 1500	0.16	0.12 - 0.30	0.10 - 0.20	0.08 - 0.20	SL 500
	1200	500 - 1500	0.16	0.12 - 0.30	0.10 - 0.20	0.08 - 0.20	SL 854 C
	1200	500 - 1500	0.16	0.12 - 0.30	0.10 - 0.20	0.08 - 0.20	SL 858 C
250 - 280	800	300 - 1200	0.16	0.12 - 0.30	0.10 - 0.20	0.08 - 0.20	SL 500
	800	300 - 1200	0.16	0.12 - 0.30	0.10 - 0.20	0.08 - 0.20	SL 854 C
	800	300 - 1200	0.16	0.12 - 0.30	0.10 - 0.20	0.08 - 0.20	SL 858 C
3.2/√ Finishing · $a_p = 0.5 - 1.0$ mm							
190 - 210	1500	800 - 2000	0.12	0.10 - 0.20	0.10 - 0.15	0.08 - 0.15	SL 854 C
220 - 240	1200	500 - 1500	0.12	0.10 - 0.20	0.10 - 0.15	0.08 - 0.15	SL 854 C
250 - 280	800	300 - 1200	0.12	0.10 - 0.20	0.10 - 0.15	0.08 - 0.15	SL 854 C
0.8/√ Finish milling · $a_p = 0.1 - 0.5$ mm							
190 - 210	700	200 - 900	0.10	0.08 - 0.20	0.08 - 0.25	0.05 - 0.12	SH 2
220 - 240	500	200 - 700	0.10	0.08 - 0.20	0.08 - 0.25	0.05 - 0.12	SH 2
250 - 280	400	200 - 500	0.10	0.08 - 0.20	0.08 - 0.25	0.05 - 0.12	SH 2

Cutting Data Recommendations for Milling Ductile Cast Iron

MATERIAL NO.	UTS (N/mm ²)									
		DIN	EN	AFNOR	B.S.	SS	UNE	UNI	AISI/SAE	JIS
0.7040	400	GGG-40	GJS-400-15	FGS 400-12	SNG 420/12	0717-02	FGE 38-17	GS 370-17	60-40-18	FCD 400
0.7050	500	GGG-50	GJS-500-7	FGS 500-7	SNG 500/7	0727-02	FGE 50-7	GS 500-7	65-45-12	FCD 500
0.7060	600	GGG-60	GJS-600-3	FGS 600-3	SNG 600/3	0732-03	FGE 60-2	GS 600-2	80-55-06	FCD 600
0.7070	700	GGG-70	GJS-700-2	FGS 700-2	SNG 700/2	0737-01	FGE 70-2	GS 700-2	100-70-03	FCD 700

Cutting speed and feed rate

TENSILE STRENGTH UTS (N/mm ²)	CUTTING SPEED v_c (m/min)		FEED RATE f_z (mm/t)			GRADE	
	RECOMMENDED VALUE	OVERALL RANGE	RECOMMENDED VALUE	OVERALL RANGE $K_r = 45^\circ$	OVERALL RANGE $K_r = 75^\circ$		OVERALL RANGE $K_r = 88^\circ$
$\sqrt[12.5]{}$ Rough milling · $ap < 5$ mm							
400 - 500	800	600 - 1000	0.16	0.15 - 0.30	0.12 - 0.25	0.08 - 0.20	SL 808
	800	600 - 1000	0.16	0.15 - 0.30	0.12 - 0.25	0.08 - 0.20	SL 858 C
500 - 700	700	500 - 800	0.16	0.15 - 0.30	0.12 - 0.25	0.08 - 0.20	SL 808
	700	500 - 800	0.16	0.15 - 0.30	0.12 - 0.25	0.08 - 0.20	SL 858 C
$\sqrt[6.3]{}$ Rough milling · $ap < 2$ mm							
400 - 500	800	600 - 1000	0.16	0.15 - 0.30	0.12 - 0.25	0.08 - 0.20	SL 854 C
	800	600 - 1000	0.16	0.15 - 0.30	0.12 - 0.25	0.08 - 0.20	SL 858 C
400 - 700	700	500 - 800	0.16	0.15 - 0.30	0.12 - 0.25	0.08 - 0.20	SL 854 C
	700	500 - 800	0.16	0.15 - 0.30	0.12 - 0.25	0.08 - 0.20	SL 858 C
$\sqrt[3.2]{}$ Finishing · $ap < 0.5 - 1.0$ mm							
400 - 500	800	600 - 1000	0.16	0.10 - 0.20	0.10 - 0.15	0.08 - 0.15	SL 854 C
500 - 700	700	600 - 1000	0.16	0.10 - 0.20	0.10 - 0.15	0.08 - 0.15	SL 854 C

Designation System for Milling Inserts according to ISO 1832

R		
S	90°	
T	60°	
H	120°	
O	135°	

Insert shape

N	0°
A	3°
B	5°
C	7°
P	11°
D	15°
E	20°
F	25°
G	30°
O	Clearance angle which requires special data.

Normal clearance angle α_n

Inscribed circle					
d mm	H 120°	O 135°	RC, RN	S 90°	T 60°
3.97					06
5.56					09
6.35					11
9.52			09	09	16
12.70			12	12	22
13.50		05		13	
15.88	09		15	15	27
16.20	10				
16.50		06			
19.05			19	19	33
25.40			25	25	44

Insert size

S

N

C

N

12

04

Tolerances

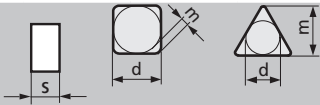

* Permissible deviations for the insert shape, depending on the insert size

	S = ± mm	d = ± mm	m = ± mm	Inscribed circle	Tolerance class				
					J, K, L, M	U	M, N	U	
				d mm	d = ± mm		m = ± mm		
A	0,025	0,025	0,005	3,97	0,05	0,08	0,08	0,13	
C	0,025	0,025	0,013						
E	0,025	0,025	0,025						
F	0,025	0,013	0,005						
G	0,130	0,025	0,025						
H	0,025	0,013	0,013						
J	0,025	0,05-0,13*	0,005						9,52
K	0,025	0,05-0,13*	0,013						12,70
L	0,025	0,05-0,13*	0,025						15,88
M	0,130	0,05-0,13*	0,08-0,18*						19,05
U	0,130	0,08-0,25*	0,13-0,38*	25,40	0,13	0,25	0,18	0,38	

Insert type

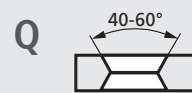

X Special design

Insert thickness

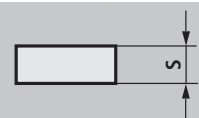

01	1,59
02	2,38
03	3,18
T3	3,97
04	4,76
05	5,56
06	6,35
07	7,94
09	9,52
12	12,70

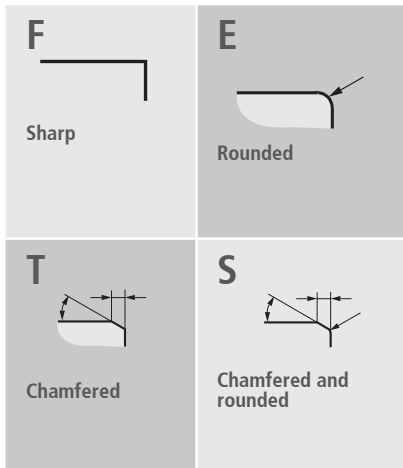

Corner design

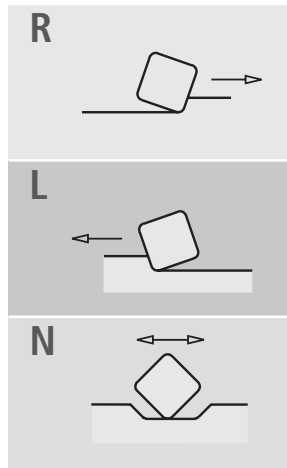

Cutting direction

Approach angle κ_r	Length of ZZ chamfer
43 = 43°	125 = 1.25 mm
47 = 47°	150 = 1.50 mm
75 = 75°	240 = 2.40 mm
88 = 88°	

Designation key for ZZ geometries

AN

T

N

01020

- 88Z240

Corner radius











Insert with corner radius		Insert with cutting edge			
00	RN, RC	Approach angle of the main cutting edge κ_r		Clearance angle α_n	
M0	RB				
02	0.2				
04	0.4				
08	0.8	A	45°	N	0°
12	1.2	D	60°	C	7°
16	1.6	E	75°	P	11°
24	2.4	F	85°	D	15°
32	3.2	P	90°	E	20°
40	4.0	Z	other angles	F	25°

Chamfer design

Chamfer width w_γ in 1/100 mm and angle γ_s without degree symbol

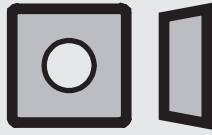
e.g.
 $0.10 \times 20^\circ = 01020$
 $0.05 \times 20^\circ = 00520$

Contents: Ceramic Inserts for Milling

HNGX	ODHW, OEHX, OPHX	ONHQ	OPHN
			
Page 83	Page 83-84	Page 84	Page 84
RNGN	SNCN, SNFN, SNGN, SNHX	SDCN, SECN, SOCN, SPCN, SPGN, SPHN, SPKN	SDHW, SEHW
			
Page 85	Page 86-88	Page 85-90	Page 85
SPHX	TNCN	TPCN	
			
Page 89	Page 91	Page 91	

INSERT	ISO	GRADE	SPK REF. NO.
HNGX 10 05 .. T 	HNGX 10 05 12 T01020	SL 500	36.60.123.20.0
		SL 808	17.60.123.20.1
	HNGX 10 05 16 T01020	SL 500	36.60.124.20.0
		SL 808	17.60.124.20.1
HNGX 10 05 16 T - 47Z125 	HNGX 10 05 16 T01020 - 47Z125	SL 500	36.60.120.20.0
	HNGX 10 05 16 T03020 - 47Z125	SL 808	17.60.120.23.1
ODHW 05 04 .. T 	ODHW 05 04 08 T 01020	SL 500	36.76.001.20.0
	ODHW 05 04 12 T 01020	SL 500	36.76.002.20.0
ODHW 06 05 .. T 	ODHW 06 05 16 T 01020	SL 500	36.76.003.20.0
OEHX 06 06 .. T 	OEHX 06 06 16 T 01020	SL 808	17.76.016.20.1

Ceramic Inserts for Milling

INSERT	ISO	GRADE	SPK REF. NO.
<p>ONHQ 06 06 .. T</p>	ONHQ 06 06 16 T 01020	SL 808	17.76.017.20.1
<p>OPHN 05 04 .. T</p>	OPHN 05 04 12 T 01020	SL 500	36.72.001.20.0
<p>OPHX 06 06 .. T</p>	OPHX 06 06 16 T 01020	SL 808	17.76.014.20.1
<p>OPHX 06 06 08 T - 43Z150</p>	OPHX 06 06 08 T 01020 - 43Z150	SL 808	17.76.015.20.1

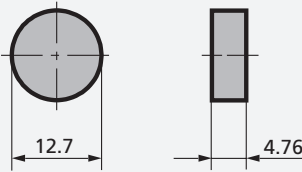
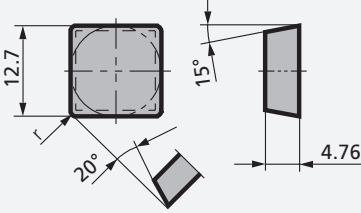
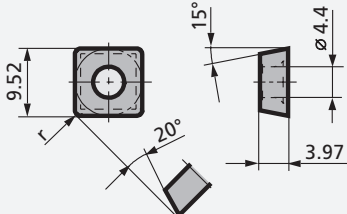
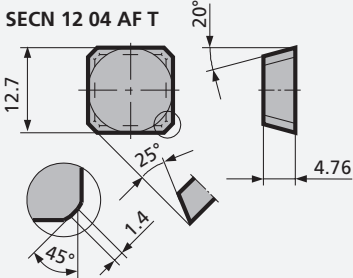
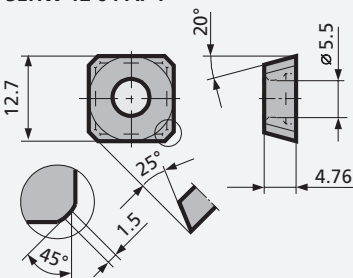
INSERT	ISO	GRADE	SPK REF. NO.
RNGN 12 04 00 T 03015 	RNGN 12 04 00 T 03015	SH 2	36.40.027.35.7
SDCN 12 04 .. T - 20 	SDCN 12 04 08 T - 20	SL 500	36.12.340.20.0
		SL 808	17.12.340.20.1
	SDCN 12 04 12 T - 20	SL 500	36.12.341.20.0
		SL 808	17.12.341.20.1
SDHW 09 T3 .. T 	SDHW 09 T3 12 T 01020	SL 500	36.16.505.20.0
SECN 12 04 AF T 	SECN 12 04 AF T 01020	SL 500	36.12.357.20.0
SEHW 12 04 AF T 	SEHW 12 04 AF T 01020	SL 500	36.16.519.20.0

Ceramic Inserts for Milling

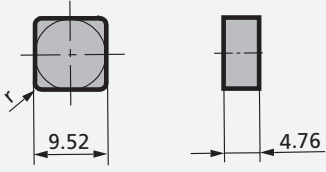
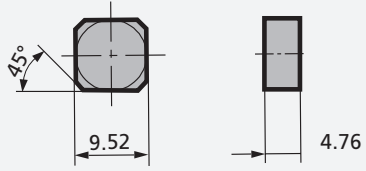
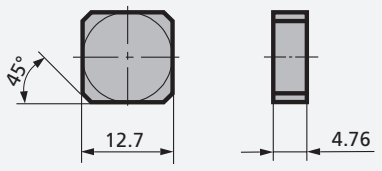
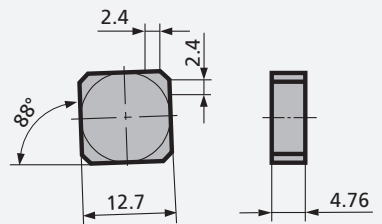
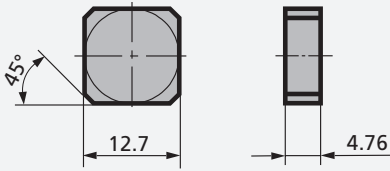
INSERT	ISO	GRADE	SPK REF. NO.
SNCN 09 04 .. T 	SNCN 09 04 04 T 00520	SL 808	17.10.454.03.1
SNCN 09 04 ZN T 	SNCN 09 04 ZN T 00520	SL 500	36.10.445.03.0
		SL 808	17.10.445.03.1
		SL 854 C	17.10.445.03.9
SNCN 12 04 ZN T 	SNCN 12 04 ZN T 00520	SL 500	36.10.409.03.0
		SL 808	17.10.409.03.1
		SL 854 C	17.10.409.03.9
SNCN 12 04 ZN T - 88Z240 	SNCN 12 04 ZN T 01020 - 88Z240	SL 500	36.10.493.20.0
		SL 808	17.10.493.20.1
SNFN 12 04 AN T 	SNFN 12 04 AN T 03015	SH 2	36.10.223.35.7

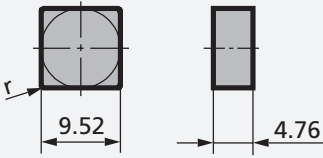
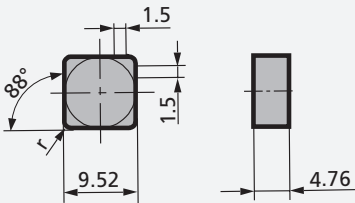
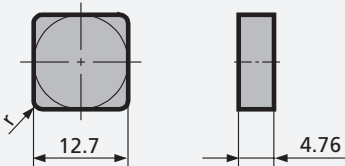
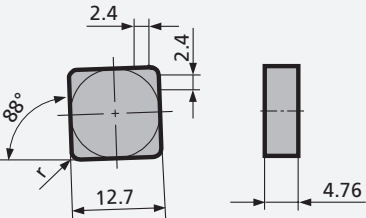
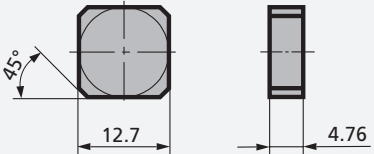
INSERT	ISO	GRADE	SPK REF. NO.
SNGN 09 04 .. T 	SNGN 09 04 12 T 01020	SL 500	36.10.050.20.0
	SNGN 09 04 12 T 03015	SH 2	36.10.050.35.7
SNGN 09 04 04 T - 88Z150 	SNGN 09 04 04 T 01020 - 88Z150	SL 808	17.10.490.20.1
SNGN 12 04 .. T 	SNGN 12 04 08 T 01020	SL 500	36.10.009.20.0
		SL 808	17.10.009.20.1
		SL 854 C	17.10.009.20.9
	SNGN 12 04 12 T 01020	SL 500	36.10.058.20.0
		SL 808	17.10.058.20.1
		SL 854 C	17.10.058.20.9
		SL 858 C	21.10.058.20.1
	SNGN 12 04 12 T 03015	SH 2	36.10.058.35.7
SNGN 12 04 08 T - 88Z240 	SNGN 12 04 08 T 01020 - 88Z240	SL 500	36.10.503.20.0
		SL 808	17.10.503.20.1
SNGN 12 04 AN T 	SNGN 12 04 AN T 01020	SL 500	36.10.232.20.0
		SL 808	17.10.232.20.1

Ceramic Inserts for Milling

INSERT	ISO	GRADE	SPK REF. NO.
SNGN 12 04 EN T 	SNGN 12 04 EN T 01020	SL 500	36.10.261.20.0
SNHX 12 04 .. T 125 	SNHX 12 04 12 T 125	SH 2	36.10.266.99.7
SOCN 12 04 .. T - 25 	SOCN 12 04 16 T - 25	SL 500	36.12.314.20.0
		SL 808	17.12.314.20.1
SPCN 12 04 .. T - 15 	SPCN 12 04 16 T - 15	SL 500	36.12.325.20.0
		SL 808	17.12.325.20.1
SPGN 12 03 .. T 	SPGN 12 03 12 T 02020	SL 500	36.12.155.20.0

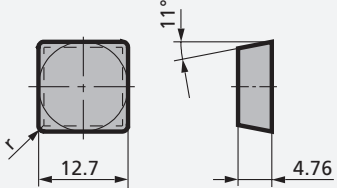
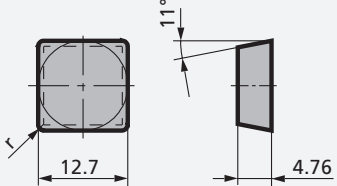
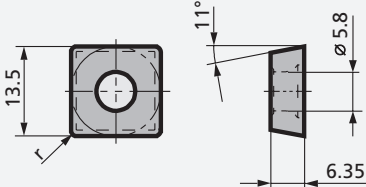
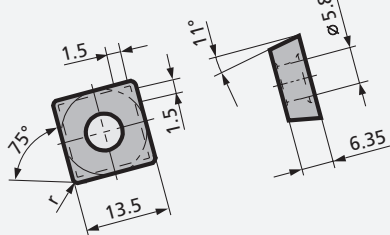
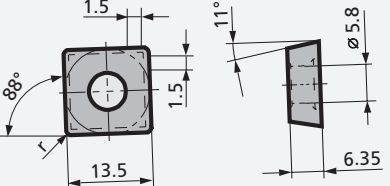
INSERT	ISO	GRADE	SPK REF. NO.
SPGN 12 04 .. T 	SPGN 12 04 12 T 02020	SL 500	36.12.163.20.0
		SL 808	17.12.163.20.1
SPHN 12 04 .. T 	SPHN 12 04 16 T 01020	SL 500	36.12.869.20.0
SPHX 13 06 .. T 	SPHX 13 06 12 T 01020	SL 808	17.16.535.20.1
SPHX 13 06 12 T - 75Z150 	SPHX 13 06 12 T 01020 - 75Z150	SL 808	17.16.537.20.1
SPHX 13 06 12 T - 88Z150 	SPHX 13 06 12 T 01020 - 88Z150	SL 808	17.16.536.20.1

Ceramic Inserts for Milling

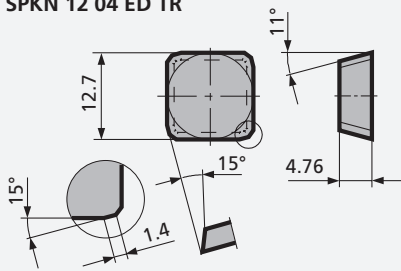
INSERT	ISO	GRADE	SPK REF. NO.
SPKN 12 04 ED TR 	SPKN 12 04 ED TR 01020	SL 500	36.12.246.20.0

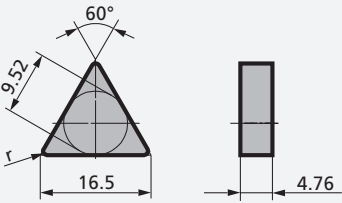
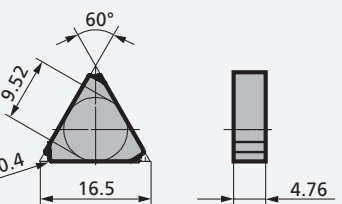
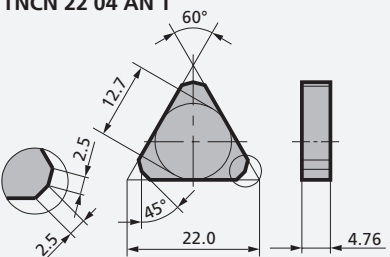
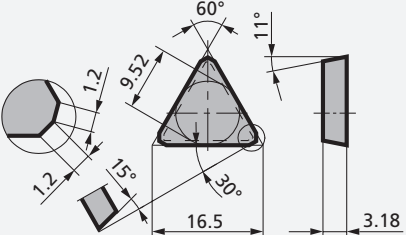
INSERT	ISO	GRADE	SPK REF. NO.
TNCN 16 04 .. T 	TNCN 16 04 04 T 01020	SL 808	17.30.190.20.1
		SL 854 C	17.30.190.20.9
	TNCN 16 04 08 T 01020	SL 808	17.30.191.20.1
		SL 854 C	17.30.191.20.9
	TNCN 16 04 12 T 01020	SL 808	17.30.192.20.1
		SL 854 C	17.30.192.20.9
TNCN 16 04 PC T 	TNCN 16 04 PC T 01020	SL 808	17.30.209.20.1
TNCN 22 04 AN T 	TNCN 22 04 AN T 01020	SL 500	36.30.100.20.0
		SL 854 C	17.30.100.20.9
TPCN 16 03 PD TN 	TPCN 16 03 PD TN 01020	SL 500	36.32.182.20.0



A series of horizontal dotted lines for taking notes.



A series of horizontal dotted lines for taking notes.



www.tools-for-productivity.com

CeramTec GmbH

SPK Cutting Tools Division
Hauptstrasse 56
73061 Ebersbach/Fils
Germany

Phone: +49 7163 166-239
Fax: +49 7163 166-388
info@spk-tools.com
www.spk-tools.com / www.ceramtec.com