

Fowler

HIGH PRECISION



Save 25%
54-520-250-0
pg. 26



Save 30%
On Sets
pg. 2



Save \$25.00
54-870-001-0
pg. 4



NEW!
pg. 44

Save \$35.00
54-100-330-1
pg. 14



TOOL-A-THON

Volume 15.3

Visit our NEW Website www.fowlerprecision.com

Fowler-Bowers XT-Series Holemikes



The Fowler-Bowers range of mechanical two and three point bore micrometers are now available as XT extended travel holemikes, allowing a wide measurement range without the need to interchange anvils.

SPECIAL DEAL!

Save 30%



Special Features:

- Graduations 0.00025"
- 3-pt contact with tungsten carbide measuring anvils above .5"
- Blind bore measuring above .5"
- Ratchet stop for consistent measuring
- Non-removable anvils
- Extensions available for deep measuring
- Setting rings included in all sets
- Includes UKAS certificates for all Holemikes and setting rings
- Every gage is individually serialized
- Special anvils available, contact the Fowler Technical Department

Order No.	Range	Grads.	Accuracy	Meas. Depth	Ring Included	List Price	Sale Price
52-255-310-0	.250"-.312"	.00025"	.00015"	2.28"	.312"	\$695.30	\$486.71
52-255-311-0	.312"-.375"	.00025"	.00015"	2.28"	.312"	643.80	450.66
52-255-312-0	.375"-.500"	.00025"	.00015"	2.28"	.5"	643.80	450.66
52-255-313-0	.500"-.625"	.00025"	.00015"	2.44"	.5"	643.80	450.66
52-255-314-0	.625"-.750"	.00025"	.00015"	2.44"	.75"	660.20	462.14
52-255-315-0	.750"-1"	.00025"	.00015"	2.60"	.75"	725.10	507.57
52-255-316-0	1"-1.375"	.00025"	.00015"	2.60"	1.375"	1033.10	723.17
52-255-317-0	1.375"-2"	.00025"	.00015"	3.15"	1.375"	1057.80	740.46
52-255-318-0	2"-2.625"	.00025"	.0002"	3.15"	2.625"	1261.80	883.26
52-255-319-0	2.625"-3.250"	.00025"	.0002"	3.15"	2.625"	1273.10	891.17
52-255-320-0	3.250"-4"	.00025"	.0002"	3.94"	3.25"	1588.30	1111.81

Fowler-Bowers XT-Series Holemike Sets

Order No.	Range	Includes	List Price	Sale Price
52-255-565-0	.250"-.375"	2 heads, 2 handles, 1 ring	\$1544.00	\$1080.80
52-255-665-0	.375"-.750"	3 heads, 3 handles, 2 rings	1758.20	1230.74
52-255-775-0	.750"-2"	3 heads, 3 handles, 2 rings	2762.50	1933.75
52-255-885-0	2"-4"	3 heads, 3 handles, 2 rings	3745.10	2621.57

LIFETIME WARRANTY



Fowler

TOOL-A-THON

Ultra-Cal V Electronic Calipers

NEW!

**Top-of-the-line Caliper!
Fowler's BEST Caliper!**

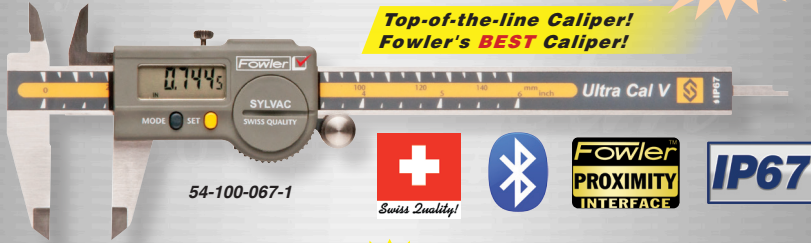

54-100-067-1



- 4-way measurement, inside, outside, depth and step. (6" & 8" models)
- Resolution: .0005"/.01mm
- Repeatability: .0005"/.01mm
- Direct inch/metric conversion
- Temperature range 5 to 40C° working; -20 to 60C° in storage

Save 25%
54-100-067-1 Model Only

- Hardened stainless steel construction
- Direct RS-232 output
- Features Absolute/Relative Measuring Modes
- Hold function
- Thumbroll (6" model only)
- Includes case

Order No.	Description	Accuracy	Resolution	List Price	Sale Price
54-100-067-1	6"/150mm	0.0008"/20µm	0.0005"/.01mm	\$194.70	\$144.00
54-100-068-1	8"/200mm	0.0012"/30µm	0.0005"/.01mm	463.50	401.70
54-100-069-1	12"/300mm	0.0012"/30µm	0.0005"/.01mm	556.20	504.70
BLUETOOTH MODELS					
54-100-167-0	NEW 6"/150mm	0.0008"/20µm	0.0005"/.01mm	324.50	288.40
54-100-168-0	NEW 8"/200mm	0.0012"/30µm	0.0005"/.01mm	602.60	540.80
54-100-169-0	NEW 12"/300mm	0.0012"/30µm	0.0005"/.01mm	803.40	638.60

Rapid-Mic Electronic Micrometers



54-815-030-0

NEW!

**Rapid Spindle Movement!
Extended Range!**

- Auto On/Off
- Position recall
- IP67 with or without data cable.
- Delrin quick displacement thimble
- Adjustable measuring force, 5N/10N
- Menu customizable with free software
- Non-rotating spindle
- USB output
- Carbide anvils
- Extended Range 0-30mm, 30-66mm and 66-102mm
- Blade anvils and specialty micrometers are available, contact Fowler Technical Department.

Save 20%
54-815-030-0 Model Only

54-815-111-0



Order No.	Description	Max Error	List Price	Sale Price
54-815-030-0	0-1.18"/0-30mm	0.00012"/.003mm	\$504.70	\$399.00
54-815-060-0	1.18"-2.6"/30-66mm	0.00016"/.004mm	746.80	700.40
54-815-100-0	2.6"-4.0"/66-102mm	0.00020"/.005mm	1044.40	942.50
BLUETOOTH MODEL				
54-815-130-0	NEW 0-1.18"/0-30mm	0.00012"/.003mm	746.80	669.50
Set				
54-815-111-0	0-4"/0-102mm		2307.20	2034.00

Prices & Specifications are subject to change without notice.

Volume 15.3

ABSOLUTE MICS

Electronic Coolant Resistant Micrometers



54-860-001-1

Save over 20%

FREE!

 Ball Attachment

Protected to:
IP54
 COOLANT & FLUID
 RESISTANT

- Protected to IP54 specifications
- Large LCD Display
- Automatic switch off
- Resolution: .00005"/.001mm
- SPC/USB data output
- Carbide measuring faces
- Absolute & incremental modes
- Sizes over 1"/25mm include standard

Order No.	Description	Range	List Price	Sale Price
54-860-001-1	IP54 Electronic Micrometer	0—1"/0—25mm	\$109.60	\$85.00
54-860-002-1	IP54 Electronic Micrometer	1—2"/25mm—50mm	126.90	95.00
54-860-003-1	IP54 Electronic Micrometer	2—3"/50mm—75mm	138.40	108.00
54-860-004-1	IP54 Electronic Micrometer	3—4"/75mm—100mm	161.50	125.00
54-860-005-1	IP54 Electronic Micrometer	4—5"/100mm—125mm	179.90	139.00
54-860-006-1	IP54 Electronic Micrometer	5—6"/125mm—150mm	201.90	155.00
54-860-103-1	IP54 Electronic Micrometer Set	0—3"/0—75mm	381.80	275.00
54-860-106-1	IP54 Electronic Micrometer Set	0—6"/0—150mm	918.20	675.00
54-100-350-0	CR2032 Battery		5.70	

XTRA-VALUE II Electronic Micrometers



54-870-001-0

Save over 25%
 54-870-103-0 Set
 Only

FREE!

 Ball Attachment

Protected to:
IP40
 DUST RESISTANT

- Jet black, grey enamel finish
- Large LCD display.
- Resolution: .00005"/.001mm
- Accuracy: ±.00016"/.004mm (up to 2")
- SPC/USB data output
- Carbide measuring faces.
- Absolute and incremental modes
- Ratchet thimble
- Includes shop hardened case



Order No.	Description	Range	List Price	Sale Price
54-870-001-0	Xtra-Value II Electronic Micrometer	0—1"/0—25mm	\$86.50	\$61.50
54-870-002-0	Xtra-Value II Electronic Micrometer	1—2"/25—50mm	87.60	77.70
54-870-003-0	Xtra-Value II Electronic Micrometer	2—3"/50—75mm	102.90	92.50
54-870-004-0	Xtra-Value II Electronic Micrometer	3—4"/75—100mm	109.20	99.00
54-870-103-0	Xtra-Value II Electronic Micrometer Set	0—3"/0—75mm	267.80	198.00
54-100-350-0	CR2032 Battery		5.70	

Swiss-Style Micrometers



52-229-201-0

**Save
over 25%**

- .0001" reading
- Carbide measuring faces
- Insulated frame
- Ratchet thimble and locking nut
- Microfine graduations
- Sizes over 1" include standard
- Meets or exceeds Federal specifications
- Includes case

Order No.	Range	List Price	Sale Price
52-229-201-0	0—1"	\$40.30	\$28.30
52-229-202-0	1—2"	47.20	34.50
52-229-203-0	2—3"	58.20	39.50
52-229-204-0	3—4"	66.80	44.50
52-229-205-0	4—5"	82.50	52.50
52-229-206-0	5—6"	96.90	63.50

Swiss Style Micrometer Sets

52-229-213-0



**Save
over 25%**

Complete in a
"Shop Hardened"
molded case!

- .0001" reading (.01mm on metric set)
- Carbide measuring faces
- Ratchet thimble and locking nut
- Microfine graduations
- Sizes over 1" include standard
- Meets or exceeds Federal specifications

Order No.	Range	List Price	Sale Price
52-229-213-0	0—3" set	\$145.30	\$100.00
52-229-214-0	0—4" set	223.80	150.00
52-229-220-0	0—100mm set	223.80	150.00

Digit Counter Micrometers



52-224-001-0

**Save
over 40%**

- Digital counter reads to .001"
- Resolution: .0001" (using vernier)
- Microfine graduations on satin chrome
- Carbide tipped measuring faces
- Positive locking nut on spindle
- Sizes over 1" include standard
- Includes case

Order No.	Range	List Price	Sale Price
52-224-001-0	0—1"	\$91.10	\$54.00
52-224-002-0	1—2"	95.70	56.90
52-224-003-0	2—3"	109.00	65.00
52-224-004-0	3—4"	119.90	69.00

Digit Counter Micrometer Sets

52-224-103-0



**Save
over 40%**

Complete in a
"Shop Hardened"
molded case!

- Digital counter reads to .001"
- Resolution: .0001" (.01mm on metric set)
- Microfine graduations on satin chrome.
- Carbide tipped measuring faces
- Ratchet thimble
- Positive locking nut on spindle
- Sizes over 1" supplied with standards

Order No.	Range	List Price	Sale Price
52-224-103-0	0—3" set	\$302.80	\$165.00
52-224-104-0	0—4" set	407.80	230.00
52-224-220-0	0—75mm set	302.80	165.00

Outside Inch Micrometers



52-240-101-1

NEW!

Fowler micrometers are of the finest quality available, at prices that defy competition. Special care in design and workmanship create a long lasting precision tool.

- Hammertone blue baked enamel finish.
- Microfine graduations on satin chrome finish and carbide tipped measuring faces.
- Diameter of measuring faces: .256"
- Graduation: .0001"
- Flatness: .00003"
- Quick, easy zero adjustment on sleeve.
- Positive lever locking clamp
- Spindle thread hardened, ground and lapped for ultimate accuracy.
- Anvil & spindle hardened and precision ground with microlap finish on tips.
- Includes a wrench and case.

**Save
over 20%
on SETS!**

Order No.	Range	Graduation	Accuracy	Thimble	List Price	Sale Price
52-240-101-1	NEW 0-1"	0.0001"	±.00015"	Ratchet	\$35.70	\$30.40
52-240-102-1	NEW 1-2" w/standard	0.0001"	±.00015"	Ratchet	41.50	35.30
52-240-003-1	NEW 2-3" w/standard	0.0001"	±.0002"	Ratchet	48.50	41.20
52-240-004-1	NEW 3-4" w/standard	0.0001"	±.0002"	Ratchet	54.20	46.10
52-240-005-1	NEW 4-5" w/standard	0.0001"	±.00025"	Ratchet	60.00	51.00
52-240-006-1	NEW 5-6" w/standard	0.0001"	±.00025"	Ratchet	65.80	55.90
52-240-007-1	NEW 6-7" w/standard	0.0001"	±.0003"	Ratchet	71.50	60.80
52-240-008-1	NEW 7-8" w/standard	0.0001"	±.0003"	Ratchet	84.20	71.60
52-240-009-1	NEW 8-9" w/standard	0.0001"	±.0003"	Ratchet	95.70	81.40
52-240-010-1	NEW 9-10" w/standard	0.0001"	±.0003"	Ratchet	108.50	92.20
52-240-011-1	NEW 10-11" w/standard	0.0001"	±.00035"	Ratchet	120.00	102.00
52-240-012-1	NEW 11-12" w/standard	0.0001"	±.00035"	Ratchet	131.50	111.80
SETS						
52-215-003-1	NEW 0-3" w/standards	0.0001"			144.20	114.00
52-215-004-1	NEW 0-4" w/standards	0.0001"			198.40	157.60
52-215-006-1	NEW 0-6" w/standards	0.0001"			305.70	243.10
52-215-012-1	NEW 0-12" w/standards	0.0001"			918.20	595.30
52-215-612-1	NEW 6-12" w/standards	0.0001"			629.80	450.00

Large Capacity Inch Micrometers

Fowler's Large Capacity Inch Micrometers are used for larger applications and is available in sizes up to a 20". Each micrometer offers superior design and workmanship to ensure high precision and long life — and at economical prices.



NEW!

**Save
20%**

- Hammertone blue baked finish
- Microfine graduations on satin chrome finish and carbide tipped measuring faces.
- Diameter of measuring faces: 0.295"
- Ratchet stop thimble for exact and repetitive readings
- Flatness: 0.00003"
- Quick, easy zero adjustment on sleeve
- Positive lever locking clamp ensures reliable measurement setting at all times
- Anvil & spindle hardened and precision ground with microlap finish on tips
- Includes standard
- Includes a wrench and case

Order No.	Range	Graduation	Accuracy	List Price	Sale Price
52-240-013-0	NEW 12-13" w/standards & case	0.001"	0.00044"/0.011mm	\$301.00	\$240.00
52-240-014-0	NEW 13-14" w/standards & case	0.001"	0.00044"/0.011mm	336.30	268.00
52-240-015-0	NEW 14-15" w/standards & case	0.001"	0.00044"/0.011mm	346.10	276.00
52-240-016-0	NEW 15-16" w/standards & case	0.001"	0.00044"/0.011mm	378.40	302.00
52-240-017-0	NEW 16-17" w/standards & case	0.001"	0.0005"/0.013mm	388.80	310.00
52-240-018-0	NEW 17-18" w/standards & case	0.001"	0.0005"/0.013mm	422.20	337.00
52-240-019-0	NEW 18-19" w/standards & case	0.001"	0.0005"/0.013mm	446.50	356.00
52-240-020-0	NEW 19-20" w/standards & case	0.001"	0.0005"/0.013mm	534.10	427.00

Micrometer Stands

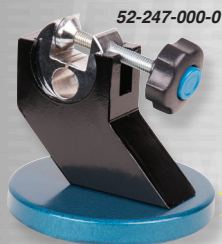

52-247-000-0

- Adjust micrometer stand to any position.
- Hammertone blue baked enamel base.
- Provides a measuring position and angle for outside micrometers and other instruments.

52-247-005-0



**Save
up to 35%**

XTRA MAG[®]



52-247-010-0

Micrometer shown
not included.

- Unique locking nut adjusts micrometer stand to any position for perfect use and viewing.
- Stand folds for storage.
- Hammertone silver baked enamel base.
- Provides a measuring position and angle for outside micrometers and other instruments.

- Holds standard 0-12" micrometers firmly to metal surfaces
- Use at machine centers, work, assembly and inspection stations, steel tables and shelves
- V-bottom for mounting on cylindrical surfaces
- On/Off magnet switch
- Blue enamel finish
- Base is 2.30" L x 1.20" W x 3.50" H



Order No.	Description	List Price	Sale Price
52-247-000-0	Adjustable Micrometer Stand	\$50.80	\$33.00
52-247-005-0	Folding Micrometer Stand	34.00	24.20
52-247-010-0	Magnetic Micrometer Stand	50.00	41.20

Prices & Specifications are subject to change without notice.

Digit Counter Ball Anvil Micrometers



52-244-201-1

NEW!

Save 15%

- Digital counter reads to .001"; sleeve reads to .0001"
- No. 52-244-201-1 spindle hardened and precision ground with a carbide tipped measuring face
- No. 52-244-301-1 anvil is hardened and precision ground
- The spherical anvil or spindle contacts the inside curved surface at a single point for accurate gaging
- Spindle thread hardened, ground & lapped
- Ratchet stop thimble on all models
- Positive locking nut on spindle

Order No.	Description	Range	Graduation	Accuracy	List Price	Sale Price
52-244-201-1	NEW Ball Anvil	0-1"	0.0001"	0.00016"	\$95.70	\$81.25
52-244-301-1	NEW Ball Anvil & Spindle	0-1"	0.0001"	0.00016"	101.50	86.10

Inch Blade Micrometers



52-246-001-1

Save over 15%

NEW!

- Use blade micrometers to measure the outside diameter of workpieces which have narrow grooves, "T" slots and other dimensions
- Anvil & spindle hardened & precision ground with microlap finish on ends.
- Non-rotating spindle
- Ratchet thimble
- Blade thickness = .030"; blade width = .256"; blade penetration = .315"
- Accuracy = .0001" for 0-1"
- Sizes over 1" include a standard.

Order No.	Range	Graduation	Accuracy	List Price	Sale Price
52-246-001-1	NEW 0-1"	0.0001"	0.00016"	\$171.70	\$143.20
52-246-002-1	NEW 1-2"	0.0001"	0.00016"	186.90	152.90

Disc Micrometers



52-250-111-1

NEW!

Save 15%

- Simplifies measuring thickness of difficult, closely spaced sections, ribs, keys, fins and more
- Anvil and spindle are hardened and precision ground with microlap finish on measuring faces
- Positive lever locking clamp
- Ratchet thimble
- Flatness: .00004"
- Accuracy and parallelism: 1" & 2": .00016"
- Sizes over 1" include standards

Order No.	Range	Graduation	Accuracy	List Price	Sale Price
52-250-111-1	NEW 0-1"	0.0001"	0.00016"	\$90.00	\$76.50
52-250-112-1	NEW 1-2"	0.0001"	0.00016"	101.50	86.10

Cylindrical and Spherical Tube Micrometers



52-510-601-1

NEW!

The anvils of tube micrometers are positioned at a 90° angle in respect to the axis of the spindle, making it practical and convenient for measuring wall thickness of tubings and other workpieces with cylindrical walls.

- Anvil is hardened and precision ground.
- Carbide tipped spindle
- Spindle thread is hardened, ground and lapped.
- Positive lever-locking clamp.
- Ratchet thimble

Order No.	Range	Graduation	Accuracy	Type	List Price	Sale Price
52-510-601-1	NEW 0-1"	0.0001"	0.00024"	Cylindrical	\$57.70	\$43.30
52-510-602-1	NEW 0-1"	0.0001"	0.00024"	Spherical	117.70	102.00

Extended Range Point Micrometers



52-234-522-0

**Save
over 60%**

Twin Conical Anvils!

Inch/Metric

- Fast, easy-to-read digit counter.
- Range: 0.3"-1.7"/7-45mm
- Digital counter reads .001"/0.01mm sleeve reads .0001"/0.01mm
- Ratchet thimble.
- Carbide tipped measuring faces.
- Includes case and measuring standard.

OVERSTOCK SPECIAL

Order No.	Description	List Price	Sale Price
52-234-522-0	NEW Extended Range Point Micrometer	\$114.20	\$45.00
52-234-523-0	NEW Extended Range Point Micrometer — Metric	114.20	45.00

Deep Throat Micrometers

Fowler's "U"-frame Deep Throat Micrometers are available with depths of 6" and 12". Use Deep Throat Micrometers for taking accurate measurements of steel and plastic sheets and plates whenever a depth measurement of 2" to 12" is needed.

Features:

- Hammertone blue baked enamel frame.
- Graduations are microfine on satin chrome finish for easy reading.
- All models feature a ratchet stop thimble for exact and repetitive readings.
- The spindle thread is hardened, ground and lapped. The anvil and spindle are hardened and precision ground with microlap finish on carbide tipped measuring faces.
- Diameter of measuring faces = .256".
- Positive lever locking clamp ensures reliable measurement at all times.
- Wrench furnished with each micrometer for fast, easy zero adjustment on the sleeve.
- Flatness: .00003"
- Parallelism: .00005"
- **52-517-612-1 supplied with a ball anvil.**
- Includes case.



52-517-611-1

NEW!

**Save
over 30%**

Order No.	Range	Graduation	Accuracy	Anvil	Throat Depth	List Price	Sale Price
52-517-611-1	NEW 0-1"	0.0001"	0.00016"	Flat	6"	\$116.50	\$81.00
52-517-612-1	NEW 0-1"	0.0001"	0.0002"	Ball	11.875"	155.70	108.00

Prices & Specifications are subject to change without notice.

Vernier Calipers

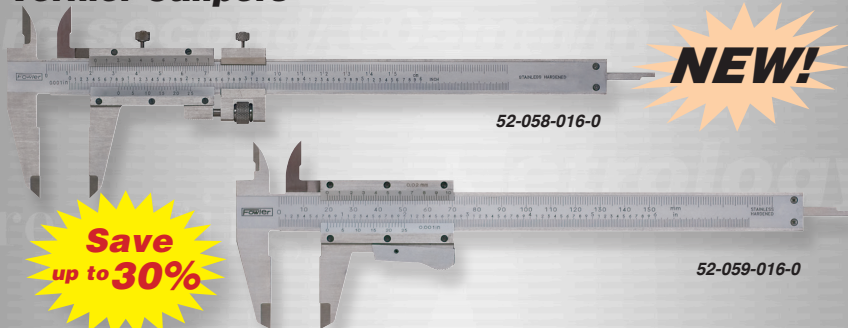

Fowler's line of fine quality vernier calipers measure accurately in inch or metric with vernier scales of .001" and .02mm.

- Made of fully hardened stainless steel; microfine black graduations on a satin chrome finish for easy, precise reading.
- All models offer a depth rod which can be read directly from verniers.
- Measuring faces are ground and lapped for extreme accuracy.
- 4-way jaws for outside, inside, depth and step measurements.
- Extra-long vernier ensures accuracy.
- All sliding surfaces are raised to prevent defacement and wear of graduations.
- All models meet or exceed U.S. Federal specifications for accuracy.
- Includes case.

Order No.	Range	Graduation	Depth of Jaws	List Price	Sale Price
Vernier Caliper with Fine Adjustment					
52-058-016-0	NEW 0-6"/0-150mm	0.001"/0.02mm	1.6"	\$47.30	\$33.10
52-058-008-0	NEW 0-8"/0-200mm	0.001"/0.02mm	1.9"	69.20	48.00
52-058-012-0	NEW 0-12"/0-300mm	0.001"/0.02mm	2.5"	107.30	75.00
Vernier Caliper with Thumb Lock					
52-059-016-0	NEW 0-6"/0-150mm	0.001"/0.02mm	1.6"	42.70	29.90

Master Vernier Caliper

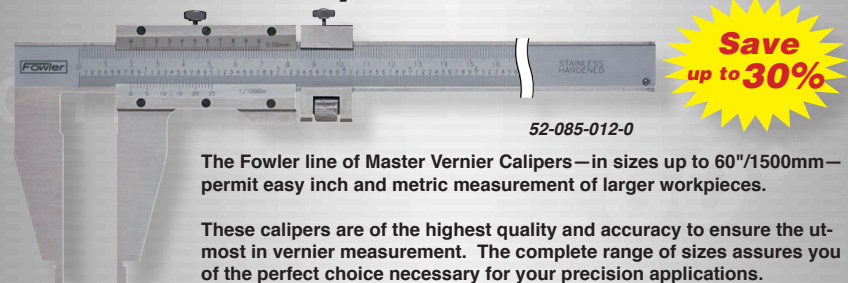

- Satin chrome finish on all models.
- Hardened stainless steel throughout; ground and lapped for accuracy.
- Extra long vernier scales have wide spaced microfine graduations on satin chrome finish to ensure easy reading.
- Machine divided and engraved from master for exceptional accuracy.
- A raised sliding surface prevents wear and defacement of microfine graduations.
- Verniers are adjustable for wear.
- Open face design permits both vernier scales to be located on one side of the gage for both inside and outside measurements.
- All sizes permit inside and outside measurements.
- For larger workpieces, the long jaws permit greater accessibility and easier measurements.
- All sizes meet or exceed U.S. Federal specifications for accuracy.
- Includes case.

Order No.	Range	Graduation	Jaw Depth	List Price	Sale Price
52-085-012-0	NEW 12"/300mm	0.001"/0.02mm	3"	\$169.60	\$118.70
52-085-024-0	NEW 24"/600mm	0.001"/0.02mm	4"	359.90	249.00
52-085-040-0	NEW 40"/1000mm	0.001"/0.02mm	5-1/2"	842.10	589.45
52-085-060-0	NEW 60"/1500mm	0.001"/0.02mm	7-1/2"	2362.00	1250.00

Premium Dial Caliper

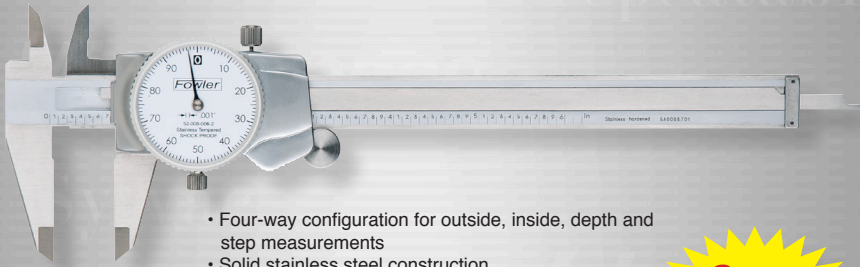

- Four-way configuration for outside, inside, depth and step measurements
- Solid stainless steel construction
- Silky smooth movement throughout
- Dial hand completes one revolution per each .100"
- Thumbroll for rapid setting
- Knurled lock assures precise settings
- Includes fitted case

**Save
over 35%**

Order No.	Range	Graduation	List Price	Sale Price
52-008-006-2	0-6"	0.001"	\$134.60	\$80.90

Machinist Grade Dial Calipers



**TOOL-A-THON
BEST SELLER!
FOWLER HIGH PRECISION**

- 4-way measuring
- Solid stainless steel construction
- Silky smooth movement throughout
- .100"/2mm range per revolution
- .001"/.02mm reading dial face
- Tough shockproof gearing
- Supplied in shop-hardened case

**Save
over 20%**

Order No.	Range	Dial Face Color	List Price	Sale Price
52-008-704-0	0-4"	White	\$53.00	\$41.00
52-008-714-0	0-4"	Black	53.00	41.00
52-008-706-0	0-6"	White	72.60	57.00
52-008-707-0	0-6"	Black	72.60	57.00
52-008-709-0	0-150mm (Metric Model)	Yellow	72.60	57.00
52-008-708-0	0-8"	White	91.10	68.20
52-008-712-0	0-12"	White	120.60	92.30

Prices & Specifications are subject to change without notice.

Heavy Duty Dial Calipers

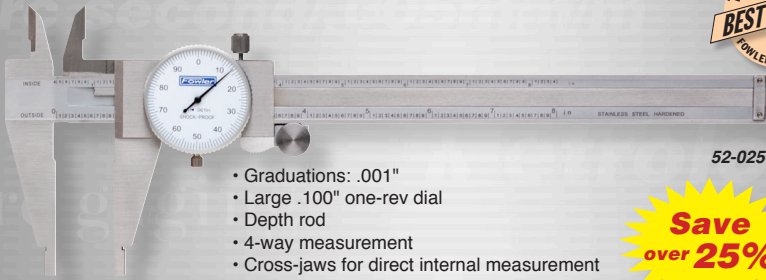

**TOOL-A-THON
BEST SELLER!**
FOWLER HIGH PRECISION

52-025-108-0

- Graduations: .001"
- Large .100" one-rev dial
- Depth rod
- 4-way measurement
- Cross-jaws for direct internal measurement
- Stainless steel, satin chrome finish
- Includes wood case

**Save
over 25%**

Order No.	Range	Jaw Length	List Price	Sale Price
52-025-108-0	8" Caliper	2.5"	\$132.10	\$97.30
52-025-112-0	12" Caliper	2.875"	192.10	138.40

0-6" Dial Calipers

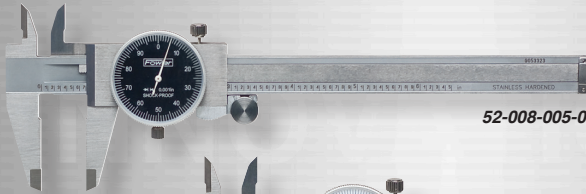

52-008-005-0

**TOOL-A-THON
BEST SELLER!**
FOWLER HIGH PRECISION

- 4-way measuring
- Covered rack
- .100" per revolution
- Dial graduation: .001"
- Accuracy: $\pm .001$ "
- Hardened stainless steel rack
- Supplied in shop-hardened case

**Save
over 40%**

52-008-007-0

Order No.	Dial Face Color	List Price	Sale Price
52-008-007-0	White	\$87.10	\$50.50
52-008-005-0	Black	84.55	50.50

Extended Range Dial Calipers

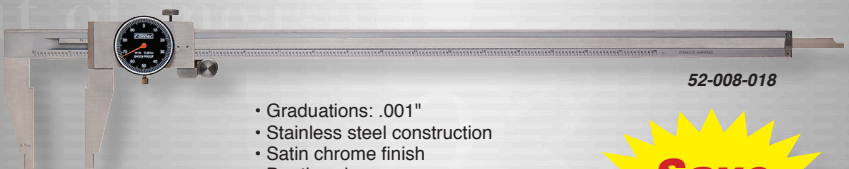

52-008-018

- Graduations: .001"
- Stainless steel construction
- Satin chrome finish
- Depth rod
- .500" internal measuring nibs
- Includes fitted case

**Save
over 20%**

**TOOL-A-THON
BEST SELLER!**
FOWLER HIGH PRECISION

Order No.	Range	Depth of Jaws	List Price	Sale Price
52-008-018-0	18" Caliper	3.125"	\$239.90	\$183.55
52-008-024-0	24" Caliper	3.375"	290.70	228.00

Poly-Cal® Electronic Caliper *Inch/Metric/Fraction*



- Range 6"/150mm
- Polycarbonate frame
- Large easy-to-read display
- Resolution .0005"/.01mm (Fractions by 1/64" increments)
- Absolute/Incremental Measurement
- Direct inch/metric/fraction conversion
- 4-way measuring
- Accuracy +/- .008"
- Supplied with clip-on vinyl pouch

Polycarbonate Caliper
Includes
• Fractional Measurement
• Easy-To-Read Display
• Lightweight frame

INCH • METRIC • FRACTION

Order No.	Description	List Price	Sale Price
54-101-175-0	Poly-Cal Electronic Caliper	\$25.30	\$19.00
54-100-350-0	CR2032 Battery	5.70	

4" thru 12" Economy Digital Calipers



Absolute Reading!

Save
20-30%

54-100-000-2



- Absolute sensor technology
- Stainless steel frame
- Direct Inch/Metric conversion
- Accuracy: .001"/.02mm (4" & 6" models)
- .0015"/.04mm (8" & 12" models)
- Resolution: .0005"/.01mm
- Large easy-to-read LCD display
- Includes molded case

Order No.	Range	List Price	Sale Price
54-100-004-2	0—4"/100mm Caliper	\$96.90	\$65.00
54-100-000-2	0—6"/150mm Caliper	113.00	75.00
54-100-008-2	0—8"/200mm Caliper	132.70	105.00
54-100-112-2	0—12"/300mm Caliper	173.00	120.00
54-100-350-0	CR2032 Battery	5.70	
54-520-399-0	Data Cable	140.00	

Water Resistant IP54 Electronic Calipers



Absolute Reading!

Save
over 25%

Protected to:
IP54
COOLANT & FLUID
RESISTANT

54-100-777-2



- Absolute sensor technology
- Water resistant to IP54 specifications
- Stainless steel frame
- Direct Inch/Metric conversion
- Accuracy: .001"/.02mm (6" models)
- Resolution: .0005"/.01mm
- Large easy-to-read LCD display
- 4-way measurement
- Includes molded case

Order No.	Range	List Price	Sale Price
54-100-777-2	0—6"/150mm Electronic IP54 Caliper	\$126.90	\$85.00
54-100-712-2	0—12"/300mm Electronic IP54 Caliper	184.60	130.00
54-100-350-0	CR2032 Battery	5.70	
54-520-399-0	Data Cable	140.00	

Pro-Max Electronic Caliper



Absolute Reading!

Save
over 30%

- Maximum Error: .001"/.02mm
- 4-way measurement, inside, outside, depth and step
- Resolution: .0005"/.01mm
- Repeatability: .0005"/.01mm
- Range: 6"/150mm
- Direct inch/metric conversion
- Temperature range 5 to 40C° working; -20 to 60C° in storage
- Hardened stainless steel construction
- RS-232 output
- Features Absolute/Relative Measuring Modes
- Hold function
- Includes molded case



Order No.	Range	List Price	Sale Price
54-200-777-1	0—6"/150mm Pro-Max Electronic Caliper	\$161.70	\$110.00
54-100-350-0	CR2032 Battery	5.70	

XTRA-VALUE CAL Electronic Calipers



54-101-150-2



- Accuracy: .001"/.02mm (6" models)
- Stainless steel frame
- Large easy-to-read display
- Resolution: .0005"/.01mm
- Direct inch/metric conversion
- Absolute/Incremental Measurement
- 4-way measuring
- Includes molded case

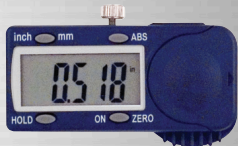

Also available with a Super Large Display with Hold Feature!

Order No.	Range	Display Type	List Price	Sale Price
54-101-150-2	6"/150mm	Regular Display	\$46.40	\$34.50
54-101-600-1	6"/150mm	Super Large Display with hold feature	57.70	38.60
54-101-200-1	8"/200mm	Regular Display	69.20	58.20
54-101-800-1	8"/200mm	Super Large Display with hold feature	86.50	66.00
54-101-300-1	12"/300mm	Regular Display	92.70	82.90
54-101-900-1	12"/300mm	Super Large Display with hold feature	115.50	88.00
54-100-350-0	CR2032 Battery		5.70	

EURO-CAL IV® Electronic Calipers



54-100-330-1

INCH • METRIC • FRACTION™

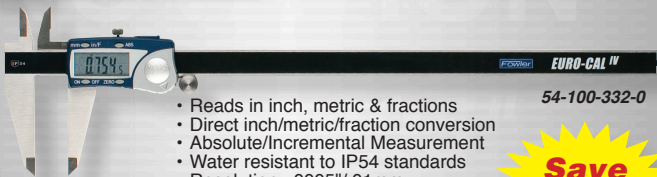

54-100-332-0



- Reads in inch, metric & fractions
- Direct inch/metric/fraction conversion
- Absolute/Incremental Measurement
- Water resistant to IP54 standards
- Resolution: .0005"/.01mm (Fractions in 1/64" increments)
- Stainless steel frame
- 4-way measuring
- Includes molded plastic case



Order No.	Description	Accuracy	List Price	Sale Price
54-100-330-1	6"/150mm Euro-Cal IV Electronic Caliper	±.001"/.02mm	\$115.30	\$80.00
54-100-331-0	8"/200mm Euro-Cal IV Electronic Caliper	±.001"/.02mm	136.50	95.00
54-100-332-0	12"/300mm Euro-Cal IV Electronic Caliper	±.0015"/.03mm	175.10	122.00
54-100-350-0	CR2032 Battery		5.70	

XTRA-RANGE® Electronic Calipers



54-100-312-0

- Hold feature
- Preset mode now includes offset for inside jaws
- All sizes feature fine adjustment screw
- Resolution: .0005"/.01mm
- Inch/metric conversion
- Includes molded case
- .500" internal measuring nibs



NEW Shop-Hardened Case!



Order No.	Range	Jaw Depth	Accuracy	List Price	Sale Price
54-100-312-0	0-12"/300mm Caliper	3.5"	.002"/.04mm	\$199.60	\$164.30
54-100-024-1	0-24"/600mm Caliper	4"	.003"/.08mm	290.70	246.60
54-100-042-1	0-40"/1000mm Caliper	4.9"	.004"/.10mm	1193.80	695.00
54-100-350-0	CR2032 Battery			5.70	

Fowler-Sylvac Ultralight IV Electronic Calipers

The **NEW** Fowler-Sylvac Ultralight IV, new design, new features, built-in Bluetooth transmitter. Discover our amazing **NEW** Ultralight long range calipers.



Features

- Built-in Bluetooth
- New reinforced frame
- XXL display with .79"/20mm high digits
- Increased accuracy
- Lengthened jaws 7.9"/200mm
- New system for internal measurement
- Protected to IP67
- Moveable left jaw
- Stainless steel titanium coated jaws
- Hold feature
- Preset function
- Min/Max functions
- Tolerance mode
- Internal and external measurement indicator
- New twin guided main beam



Swiss Quality!



Specifications	54-110-512-0	54-110-524-0	54-110-540-0	54-110-560-0	54-110-580-0
Measuring Range	0-15"/0-400mm	0-24"/0-600mm	0-40"/0-1000mm	0-60"/0-1500mm	0-80"/0-2000mm
Maximum Error	30µm/0.0012"	40µm/0.0016"	50µm/0.002"	90µm/0.0035"	120µm/0.0048"
Repeatability	20µm/0.0008"				30µm/0.0012"
Measuring Force	5 - 10 N				
Connection	Bluetooth Smart/Proxi. - RS232 or - USB				
Protection Rating	IP67 (Electronic Module)				
Preset Max.	±9999.99 mm / ±399.9995 IN				
Weight	1.5 kg	1.6 kg	1.9 kg	2.3 kg	2.6 kg

Order No.	Description	List Price	Sale Price
54-110-512-0	NEW 0-15"/0-400mm Ultralight IV	\$2086.50	\$1807.70
54-110-524-0	NEW 0-24"/0-600mm Ultralight IV	2434.30	2108.40
54-110-540-0	NEW 0-40"/0-1000mm Ultralight IV	2801.60	2521.40
54-110-560-0	NEW 0-60"/0-1500mm Ultralight IV	4212.70	3791.40
54-110-580-0	NEW 0-80"/0-2000mm Ultralight IV	5804.10	5223.10

Prices & Specifications are subject to change without notice.

Snap-Cal

Fowler's Inch, Metric & Fraction reading Snap Caliper is ideal for measuring a wide range of materials from metal, plastics and glass to small wires, fibers and paper.

INCH • METRIC • FRACTION

- Range: 0—1.25"/31.5mm
- Resolution: .0005"/.01mm (Fractions in 1/64th increments).
- Spring-loaded travel.
- Wide faced flat jaw for easy positioning.
- Dimensions of fixed jaw: .470" x .900"
- Accuracy: ±.001"/.02mm
- Hardened stainless steel construction.
- Direct inch/metric/fraction conversion.
- Measuring speed of 60"/second.
- Large, high contrast LCD display
- Hanging loop included for attachment to belt or chain.



Leather Hollister Included!

Order No.	Range	List Price	Sale Price
54-550-000-1	Snap-Cal	\$134.10	\$102.00
54-100-350-0	CR2032 Battery	5.70	

XTRA-VALUE Internal & External Electronic Caliper Gages



54-554-630-0

Save 25%

- Robust housing
- Large LCD display
- Reading: .01"/.1mm/1/64ths
- Accuracy: .01"/.3mm/1/64ths
- Battery: CR2032
- Spring loaded with locking nut



54-554-730-0

INCH • METRIC • FRACTION

Order No.	Description	Range	List Price	Sale Price
54-554-630-0	Outside Caliper Gage	0-6"/150mm	\$45.60	\$34.00
54-554-730-0	Inside Caliper Gage	.5-6"/150mm	45.60	34.00
54-100-350-0	CR2032 Battery		5.70	

XTRA-VALUE Digital Thickness Gage



Save 25%

- Range: 0-1"/25mm
- Robust housing
- Large LCD display
- Reading: 0.001"/0.01mm/1/64ths
- Accuracy: 0.004"
- Includes 1/8" ball contact, cone point and a 1mm spline point
- Battery: CR2032
- Three interchangeable points
- Battery life: approximately 1 year
- M2.5 contact point thread



INCH • METRIC • FRACTION

Order No.	Description	Range	List Price	Sale Price
54-554-830-0	Xtra-Value Digital Thickness Gage	0-1"/25mm	\$51.40	\$38.00

Small Hole Gage Set

Fowler's Small Hole Gage Set offers those in the metal working industry a tool for gaging deep and shallow holes, slots, etc. that are difficult to measure.

- Knurled knob at the end of the handle is used for size adjustment
- Hole size is obtained by measuring over the contact points with a micrometer.
- The gaging surface is a full-round with a flat bottom. This permits use in the smallest of shallow holes, slots and grooves, etc.
- Gaging surface is fully hardened to ensure long tool life
- Extra long for gaging deep and shallow holes, slots and similar work.
- The complete set of four gages covers a range of 0.125" - 0.500"
- Includes fitted vinyl case



Order No.	Description	Range	List Price	Sale Price
52-472-104-0	Small Hole Gage Set (set of four)	0.125" - 0.500"	\$81.40	\$74.50

Telescoping Gage Sets

Another great tool for easy and accurate measurements. Under spring tension, the plungers of the gage expand from the center to the size of the hole being measured and are then locked in place using the knurled knob. Final hole size is obtained by measuring over the contacts with a micrometer or vernier caliper.

- Contact points are constructed of hardened tool steel, precision ground.
- Double action rigid handle with self-centering feature for quick checking of inside measurements.
- Constant spring tension for uniform feel.
- Covers a measuring range of 5/16" to 6" with measurable depths of 4" to 5".
- Includes fitted vinyl case.



Save over 30%

52-470-006-0

Order No.	Description	Range	List Price	Sale Price
52-470-006-0	6" Telescoping Gage Set (set of six)	5/16" - 6"	\$101.80	\$62.00
52-470-007-0	12" Telescoping Gage Set (set of six)	5/16" - 6"	122.60	\$75.00

Titanium Coated Telescoping Gage Set

Another great tool for easy and accurate measurements. Under spring tension, the plungers of the gage expand from the center to the size of the hole being measured and are then locked in place using the knurled knob. Final hole size is obtained by measuring over the contacts with a micrometer or vernier caliper.

- Contact points are constructed of hardened tool steel, precision ground. Features titanium coated points for consistent accuracy and increased durability.
- Double action rigid handle with self-centering feature for quick checking of inside measurements.
- Constant spring tension for uniform feel.
- Covers a measuring range of 5/16" to 6" with measurable depths of 4" to 5".
- Includes fitted vinyl case.

Save 30%



Order No.	Description	Range	List Price	Sale Price
52-470-000-0	Titanium coated Telescoping Gage Set (set of six)	5/16" - 6"	\$113.20	\$79.00

Inside Micrometers

With Fowler Inside Micrometers you are assured of smooth operation and stabilized uniform accuracy. The frame is specially designed to enable the micrometer to provide extremely accurate small internal measurements.



**Save
20%**

- Satin chrome finish on barrel and thimble
- Measuring faces are fully hardened, precision ground and microlap finished to assure exceptionally accurate measuring
- Spindle threads are hardened and ground
- Microfine graduations 0.001"/0.01mm on a satin chrome finish permit easy reading
- Accuracy to 0.0002"/0.005mm
- Ratchet stop thimble assures exact and repetitive readings
- Easy zero adjustments on the sleeve
- Meets or exceeds Federal accuracy specs.
- Includes a setting ring
- Includes a spanner wrench and a case

Order No.	Range	Graduation	Accuracy	List Price	Sale Price
52-275-001-1	NEW 0.2" - 1.2"	0.001"	0.0002"	\$91.10	\$71.00
52-275-002-1	NEW 1" - 2"	0.001"	0.0002"	98.10	78.00
52-275-005-0	NEW 0.2" - 2.2"	0.001"	0.0002"	154.00	123.00

Inside Micrometers

Fowler extension rod type Inside Micrometers have a wide measuring range — any one single micrometer can replace many bar type inside micrometers.

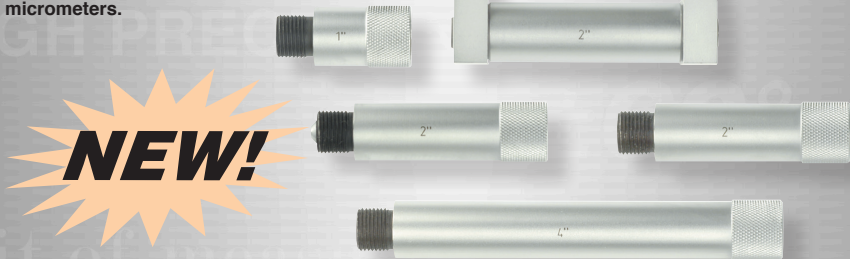

**Save
20%**

- Each set consists of an inside micrometer head and a series of fully hardened and lapped extension rods of different lengths all with carbide measuring faces
- Anvil and spindle are hardened and precision ground with microlap finish on ends
- Spindle thread hardened, ground and lapped
- Microfine graduations on satin chrome
- Positive locking nut on spindle
- It is recommended that the inside micrometer with extensions be calibrated by a micrometer or ring gage
- Coiled spring pressure contact type rods are each marked with appropriate length
- Accuracy = $0.00005" \times (3 + L"/2)$
- Meets or exceeds Federal accuracy specs.
- Reference standard included with set
- Includes a wrench and a case

Order No.	Range	Graduation	List Price	Sale Price
52-243-026-1	2" - 6"	0.001"	\$120.00	\$96.00
52-243-212-1	2" - 12"	0.001"	148.20	118.00
52-243-220-1	2" - 20"	0.001"	192.10	153.00
52-243-240-1	2" - 40"	0.001"	508.10	406.00
52-243-260-1	2" - 60"	0.001"	914.40	731.00
52-243-480-1	4" - 80"	0.001"	1071.20	856.00
52-243-512-1	2" - 120"	0.001"	2339.50	1871.00

INDI-MAX

Electronic Indicators

- Direct Inch/Metric Conversion
- IP54 Coolant & fluid resistant
- Auto Off feature
- 2-1/4" dial face
- 3/8" stem - 4-48 thread
- Resolution .00005"/.001mm
- Accuracy: .00016"/.004mm (to 1")
- Tolerance indicators
- Absolute/incremental reading
- Lugback supplied on 1/2" model.
- Lugbacks for 1" and 2" models, 52-525-605-0
- Floating zero
- Carbide tipped point

Fowler

TOOL-A-THON

**Save
25%**

Protected to:
IP54
COOLANT & FLUID
RESISTANT



0-.5"



0-1"



0-2"

Carbide-tipped points!



Order No.	Description	List Price	Sale Price
54-520-305-0	.5"/12.5mm Indi-Max Electronic Indicator with point set	\$338.90	\$250.00
54-520-310-0	1"/25mm Indi-Max Electronic Indicator with point set	380.10	285.00
54-520-320-0	2"/50mm Indi-Max Electronic Indicator with point set	493.40	365.00
54-100-350-0	CR2032 Battery	5.50	
54-520-399-0	Data cable	140.00	

Prices & Specifications are subject to change without notice.

EZ-ID/OD Electronic Gage

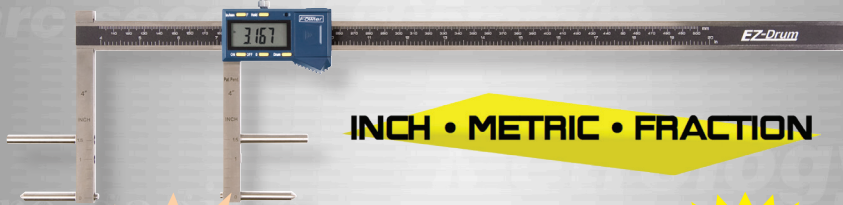

INCH • METRIC • FRACTION

NEW!



- 4" to 20"/100 to 500mm capacity
- Inch/Metric/Fraction Conversion
- 4" preset
- Zero set
- Hold function
- Preset measuring depth at 1" or 1.5"
- Resolution: 0.0005"/0.01mm (fractions in 1/64" increments)
- Protected to IP54 specifications
- Beam has vernier scale to double check reading
- Thumblock
- Direct RS232 output
- Includes wooden case

Save over 30%

Order No.	Range	List Price	Sale Price
54-150-020-0	NEW 4"-20"/100-500mm EZ-ID/OD Electronic Gage	\$370.80	\$255.00
54-100-350-0	CR2032 Battery	5.70	

Ultra-Cal III Electronic Depth Gage

Improved electronics with Direct RS232 Output. Available in two styles, these computerized measuring tools combine the advantages of Fowler's "Ultra-Cal III" Swiss patented measuring system with the rugged design of a full 12" capacity depth gage. Together they replace conventional vernier and dial depth gages and depth micrometers.

NEW!



Save over 20%

Identical except for the end style, both tools feature an LCD display to .0005" (.01mm) resolution, direct inch/metric conversion, incremental floating zero, and the Sylvac non-contact measuring system (no glass scales, racks, etc.).

Model No. 54-130-012-0:

Features a "hook" style end. Ideal for thru-holes, shoulders, recesses, measuring of wall thickness, etc. Length of leg: .584".

Model No. 54-135-012-0:

Features a standard style end. For small hole entry, general gaging, blind holes, etc.

Specifications of Both Models:

- Base length: 6"; base width: .300"; beam width: .637"; beam thickness: .120".
- Low drain, high efficiency lithium wafer battery (environmentally safe for disposal) offers 4500 hours of continuous on-time. Life extended 2—3 years with use of on/off switch.
- Price includes battery & deluxe wood case.



Order No.	Description	Range	Resolution	List Price	Sale Price
54-130-012-0	NEW Depth Gage with Hook	0-12"/300mm	0.0005"/0.01mm	\$985.70	\$785.00
54-135-012-0	NEW Depth Gage with standard	0-12"/300mm	0.0005"/0.01mm	887.10	699.00

Economy Depth Micrometers



**Save
over 10%**

52-225-116-0



- Satin chrome finish
- Base surface hardened, ground & lapped
- Ratchet thimble
- Locking clamp
- .001" Graduation
- Rod diameter: .176"
- Includes shop-hardened case.

Order No.	Range	Graduation	Base	List Price	Sale Price
52-225-110-0	0—4"	.001"	2.5"	\$116.00	\$102.80
52-225-112-0	0—6"	.001"	2.5"	143.60	126.30
52-225-114-0	0—4"	.001"	4"	125.30	110.20
52-225-116-0	0—6"	.001"	4"	146.80	131.00

Digit Counter Depth Micrometers

- Easy-to-read digit counter
- Microfine .001" graduations
- 4" base constructed of tool steel, hardened and ground
- Satin chrome finish
- Ratchet thimble
- Locking clamp
- Rod diameter: .176"
- Includes wrench and fitted case



**Save
10%**

52-225-226-0

Order No.	Range	Graduation	Base	List Price	Sale Price
52-225-176-0	0—6"	.001"	2.5"	\$155.20	\$136.00
52-225-226-0	0—6"	.001"	4"	160.50	144.20

IP54 Electronic Depth Micrometer

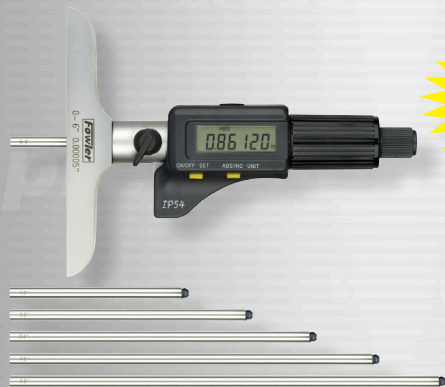

**Save
over 15%**

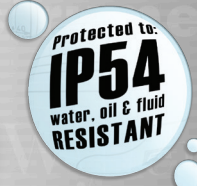

- Resolution: .00005"/.001mm
- Range: 0—6"/150mm
- Hardened tool steel, precision ground and microlapped 4" base
- Rod diameter: .176"
- Protected to IP54 standards
- Automatic switch off
- Large LCD display
- Includes fitted case

Order No.	Description	Accuracy	List Price	Sale Price
54-225-456-0	0—6"/150mm Electronic Depth Micrometer	0.00016"/0.004mm	\$205.90	\$167.80

X-PROOF® 0-22" Dial Depth Gage with IP54 protection!

BEST VALUE!
IP54 Shockproof indicator available!



- 0-1" AGD Group 2 IP54 Indicator
- Sealed bezel, top cap and dial with bellows on stem
- Sealed back plate
- .001" graduations
- 4" base ground and lapped for flatness
- Rods connect for 22" capacity
- Includes 2 extra points (spline & needle)
- Tolerance ranges

Save over 30%



All in a shop-hardened case!

Order No.	Description	Accuracy	List Price	Sale Price
52-125-007-0	X-Proof Depth Gage	± 0.001"	\$190.60	\$125.70

X-DEPTH 22® 0-22" Depth Gage

Twice the range of competitive products!

- 0—1" travel indicator
- .001" Graduations
- Rods connect together for full 22" capacity
- Satin chrome finish
- Base size: 4"
- Includes 2 extra points for small hole applications; one 0.078" dia. x 1" long and one needle point x 1" long
- Includes shop-hardened case



Save over 30%

Order No.	Description	Accuracy	List Price	Sale Price
52-125-006-1	0 - 22" Depth Gage	± 0.001"	\$175.40	\$115.00

X-DEPTH 22-E 0-22" Electronic Depth Gage

Save over 30%



- 0-1" travel electronic indicator
- Zero reset at any position
- On/off button
- Relative/absolute measuring
- Bottom surface of the base is hardened, ground & lapped
- Full 22" range
- Resolution .0005"/.01mm
- Hold feature
- 4" Base
- Includes 2 extra points for small hole applications; one 0.078" dia. x 1" long and one needle point x 1" long
- Includes shop-hardened case

Order No.	Description	Accuracy	List Price	Sale Price
54-125-777-0	0 - 22" Electronic Depth Gage	± 0.001"	\$236.40	\$162.90

XTEST X-Test Indicators

TWICE the range of most indicators!

- Jeweled movement
- Revolution counter
- Easy-to-read tilted dial
- Automatic reversal
- 210° Swivel arc
- 5/32" stem
- Tungsten carbide point: .080"
- Range: .060" inch model
- Range: 1.6mm metric model

Save 10%



52-562-001-0

52-562-002-0



2Xtra™
Contact Points
.040" & .120"
w/ purchase

Order No.	Description	Graduations	Dial Diameter	Dial Reading	List Price	Sale Price
52-562-001-0	X-Test Indicator	.0005"	1-1/2"	0-15-0	\$121.10	\$105.50
52-562-002-0	X-Test Indicator	.0005"	1"	0-15-0	121.10	105.50
52-562-003-0	X-Test Indicator	.001"	1"	0-15-0	121.10	105.50
52-562-007-0	X-Test Indicator	.01mm	25mm	0-40-0	121.10	105.50
52-562-008-0	X-Test Indicator	.01mm	38mm	0-40-0	121.10	105.50

XTEST Vertical X-Test Indicators

TWICE the range of most indicators!

- Range: .060"
- Dial reading: 0-15-0
- Jeweled movement
- Revolution counter
- Easy-to-read tilted dial
- Automatic reversal
- 210° Swivel arc
- 5/32" stem
- Tungsten carbide point: .080"

Save 10%



2Xtra™
Contact Points
.040" & .120"
w/ purchase

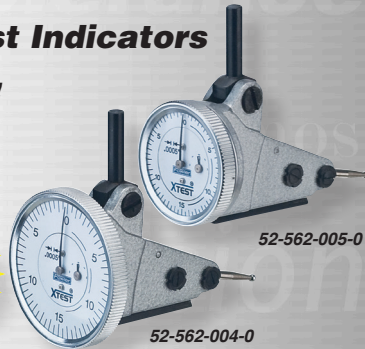

52-562-005-0

52-562-004-0

Order No.	Description	Graduations	Dial Diameter	List Price	Sale Price
52-562-004-0	Vertical X-Test Indicator	.0005"	1-1/2"	\$132.60	\$113.20
52-562-005-0	Vertical X-Test Indicator	.0005"	1"	132.60	113.20
52-562-006-0	Vertical X-Test Indicator	.001"	1"	132.60	113.20

XTEST X-Test Indicator & Accessory Combo Kits

Each Combo Kit Includes:

- X-Test Dial Test Indicator (see above)
- Axial support
- Height gage bar with clamp
- Adaptor sleeve: 5/32" to 3/8"
- Contact point case
- Contact point wrench
- Complete in "Shop Hardened" case.

Save 10%



2Xtra™
Contact Points
.040" & .120"
w/ purchase



52-562-110-0

Order No.	Description	Graduations	List Price	Sale Price
52-562-100-0	52-562-001 w/accessories	.0005"	\$177.80	\$159.00
52-562-110-0	52-562-002 w/accessories	.0005"	177.80	159.00
52-562-120-0	52-562-003 w/accessories	.001"	177.80	159.00

Prices & Specifications are subject to change without notice.

Test Indicators

All Fowler Test Indicators include bi-directional constant clockwise rotation, automatic reversal, three dovetail mountings, jeweled movement, two dovetail clamps and a molded case.



52-562-775-0



52-562-778-0



**Save
over 35%**

**TOOL-A-THON
BEST SELLER!
FOWLER HIGH PRECISION**

Extra Points



Order No.	Face Color	Total Range	Dial Reading	Graduation	Dial Diameter	Point Length	List Price	Sale Price
52-562-774-0	white	.030"	0-15-0	.001"	1"	1/2"	\$108.50	\$62.50
52-562-778-0	black	.030"	0-15-0	.0005"	1"	1/2"	115.30	67.50
52-562-775-0	white	.030"	0-15-0	.0005"	1"	1/2"	115.30	67.50
52-562-776-0	white	.030"	0-15-0	.0005"	1-1/2"	1/2"	120.60	74.00
52-562-780-0	black	.030"	0-15-0	.0005"	1-1/2"	1/2"	120.60	74.00



52-563-772-0

**Save
over 15%**



52-563-777-0

Extra Points



Order No.	Face Color	Total Range	Dial Reading	Graduation	Dial Diameter	Point Length	List Price	Sale Price
52-563-770-0	white	.008"	0-4-0	.0001"	1"	1/2"	\$115.30	\$93.10
52-563-771-0	black	.008"	0-4-0	.0001"	1"	1/2"	115.30	93.10
52-563-777-0	white	.008"	0-4-0	.0001"	1-1/2"	1/2"	115.30	93.10
52-563-772-0	black	.008"	0-4-0	.0001"	1-1/2"	1/2"	115.30	93.10

**Save
over 20%**



52-562-784-0

Extra Points



Order No.	Face Color	Total Range	Dial Reading	Graduation	Dial Diameter	Point Length	List Price	Sale Price
52-562-781-0	white	.020"	0-10-0	.0005"	1"	1-7/16"	\$118.80	\$89.80
52-562-782-0	black	.020"	0-10-0	.0005"	1"	1-7/16"	118.80	89.80
52-562-783-0	white	.020"	0-10-0	.0005"	1-1/2"	1-7/16"	118.80	89.80
52-562-784-0	black	.020"	0-10-0	.0005"	1-1/2"	1-7/16"	118.80	89.80

Premium Dial Indicators

Fowler

TOOL-A-THON

Volume 15.3

**3 year
Warranty**

with
Certificate of Calibration

NEW!

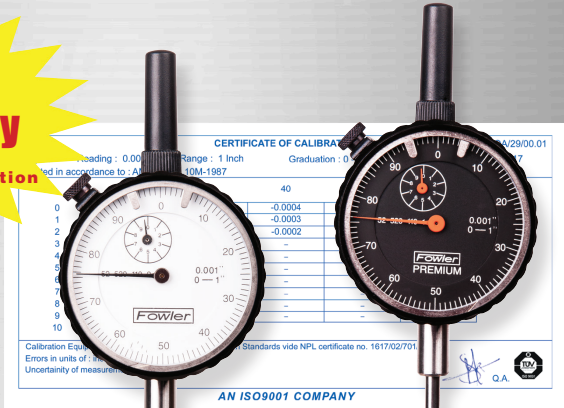

- Popular AGD 2 series
- Various graduations available
- Jet console-black dial face with orange hand (52-520-110-1)
- Various ranges available
- 0—, 100 continuous reading
- Solid brass housing
- Carbide contact point
- Includes certificate of calibration

52-520-110-2

52-520-110-1

**Save
20%**

Order No.	Range	Graduation	Reading	Balanced Reading	Dial Color	List Price	Sale Price
52-520-110-1	NEW 1"	0.001"	0-100	—	Black Face	\$85.00	\$68.00
52-520-110-2	NEW 1"	0.001"	0-100	—	White Face	85.00	68.00
52-520-105-0	NEW 0.500"	0.001"	0-100	0-50-0	White Face	80.40	64.00
52-520-120-0	NEW 2"	0.001"	0-100	0-50-0	White Face	131.50	104.00
52-520-129-0	NEW 1"	0.0005"	0-50	0-25-0	White Face	102.80	81.00
52-520-135-0	NEW .05"	0.0001"	0-10	0-5-0	White Face	147.30	117.00
52-520-125-0	NEW 0.250"	0.0005"	0-50	0-25-0	White Face	112.20	89.00
52-520-127-0	NEW 0.250"	0.0005"	—	0-25-0	White Face	105.40	84.00
52-520-128-0	NEW 1"	0.0005"	0-50	—	White Face	123.50	98.00
52-520-300-0	NEW 10mm	0.01mm	0-100	0-50-0	White Face	95.20	76.00
52-520-400-0	NEW 5mm	0.002mm	—	0-10-0	White Face	153.00	122.00
52-520-500-0	NEW 25mm	0.01mm	0-100	0-50-0	White Face	129.40	103.00

Test Indicator Set with Certificate of Calibration

Test Indicator:

- Auto-reverse.
- Jeweled movement.
- Range: .030"
- Graduation: .0005"
- Dial Reading: 0-15-0
- Dial Diameter: 1.125"
- Point length: .400"
- Carbide contact points

Set Also Includes:

- .080" & .040" contact points
- Universal clamp
- Height gage attachment
- 3/8" & 1/4" dovetail clamps
- Test certificate
- All in a fitted molded case.

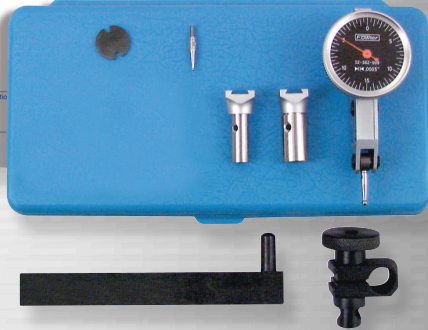
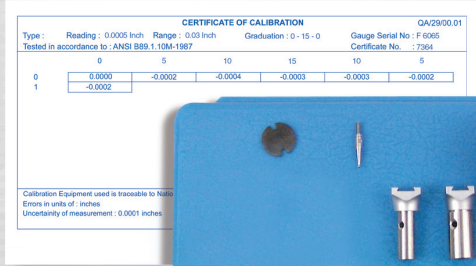

Order No.	Range	Dial Reading	Graduation	Dial Diameter	Point Length	List Price	Sale Price
52-562-999-0	0.030"	0-15-0	0.0005"	1.125"	0.400"	\$115.50	\$105.60

Prices & Specifications are subject to change without notice.

Magnetic Back

- Use for positioning on any metal surface
- Protective coating
- Attaches to dial indicators with 4-screw backs and 1.8" centerline distance (diagonal)
- Good for confined areas

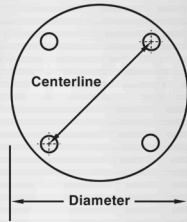

Order No.	Description	List Price	Sale Price
52-520-485-0	Magnetic Back w/52-520-110-0 Indicator	\$106.45	\$69.00

X-PROOF® IP54 Shockproof Indicators

BEST VALUE!
IP54 Shockproof indicator available!



Protection Includes:

- Rubber bellows on stem
- O-ring seal on safety cap
- O-ring protection for bezel and rotating dial
- Sealed back plate

Specifications:

- Robust, shockproof design
- Travel: 1"
- Reading: .001"
- Continuous reading: 0-100
- Tolerance markers
- AGD Group 2, 2-1/4" dia.
- Lugback and carbide point

Order No.	Description	List Price	Sale Price
52-520-450-0	X-Proof — Whiteface	\$71.50	\$45.00
52-520-455-0	X-Proof — Blackface	77.30	48.00

INDI-X^{blue}® Electronic Indicators

Available in .5"/12.5mm & 1"/25mm ranges!

INCH • METRIC • FRACTION™

- Direct Inch/Metric Conversion
- Auto Off feature
- 2-1/4" dial face
- Lugback and 3/8" stem mountings
- Resolution .0005"/.01mm
- Tolerance indicators
- Absolute/incremental reading
- Floating zero
- Carbide tipped point



Carbide-tipped point!

Order No.	Description	List Price	Sale Price
54-520-250-0	1"/25mm Indi-X Blue Electronic Indicator	\$96.80	\$72.00
54-520-260-0	1"/25mm/64ths Indi-X Blue Inch-Metric-Fraction Electronic Indicator	99.10	73.50
54-520-255-0	.5"/12.5mm Indi-X Blue Electronic Indicator	89.90	63.50

X-LOCK Locking-arm Mag Base & Indicator Set



NEW!



Locking-arm Mag Base features:

- Accepts all AGD dial indicators with 3/8" mount and test indicators
- Length of arm 6"
- Push button magnetic base
- The central locking mechanism allows for easy set up of gages

AGD Indicator features:

- 1" travel
- Continuous reading: 0-100
- AGD group 2, 2-1/4" dial diameter
- Revolution counter
- Tolerance markers
- Lug back mount
- Carbide point

Includes shop-hardened case!

Save 35%



Includes FREE contact point set!
52-525-065-0

Order No.	Description	List Price	Sale Price
52-588-030-0	NEW X-LOCK Locking-arm Mag Base & Indicator Set	\$92.70	\$58.00

Dial Indicator

NEW!

- AGD Group 2
- Range: .250"
- 0.001" graduations
- Shockproof ultra smooth gearing
- 0-100 reading
- Revolution counter
- Center lug back
- Tolerance markers
- Carbide ball contact point
- 3/8" mounting stem
- Bezel lock for easy zero setting



Save 60%

SPECIAL SALE!

OVERSTOCK SPECIAL

Order No.	Description	List Price	Sale Price
52-520-100-0	NEW Dial Indicator	\$78.40	\$31.00

Prices & Specifications are subject to change without notice.

Fowler-Bowers Holematic XTH3 Pistol Grips Sets

Fowler-Bowers XTH3 Holematic Pistol Grip bore gages offer extended travel with fixed anvils. The pistol grip handle incorporates a constant measuring force to eliminate operator "feel".



NEW Larger Display!
NEW Ergonomic Design!
NEW Four Presets!
NOW Available with Bluetooth!



- Larger (10mm) easier to read swivel display
- Self centering heads
- USB connectivity, Bluetooth is available
- Four preset memories
- Fixed anvils
- Resolution: .00005" / .001mm
- Range .080"—12" (2—300mm)
- To reduce hand fatigue, the travel of the Holematic trigger is adjustable for minimum over travel
- Tungsten carbide measuring faces on all 3-point heads from .5" (12.5mm) and up.
- Heads with special anvils available for threads, splines, slots, etc.
- Sizes over .500" (12.5mm) feature blind bore capability
- Setting rings included in all sets
- Includes UKAS certificates for all pistol grip, heads and rings
- Special anvils available
- Contact the **Fowler Technical Department** for special anvil applications.



Available with BLUETOOTH!
 Contact the **Fowler Sales Department** for more information.



54-567-020-0

Complete Range Sets

Order No.	Range	Includes	List Price	Sale Price
54-567-009-0	.080"—.250" (2—6mm)	5 heads, 1 handle, 3 rings	\$5739.00	\$4878.15
54-567-010-0	.250"—.375" (6—10mm)	2 heads, 1 handle, 1 ring	2154.00	1830.90
54-567-020-0	.375"—.750" (10—20mm)	3 heads, 1 handle, 2 rings	2547.00	2164.95
54-567-050-0	.750"—2" (20—50mm)	3 heads, 1 handle, 2 rings	3334.00	2833.90
54-567-100-0	2—4" (50—100mm)	3 heads, 1 handle, 2 rings	3730.00	3170.50
54-567-105-0	4—6" (100—150mm)	2 heads, 1 handle, 1 ring	3334.00	2833.90
54-567-110-0	6—8" (150—200mm)	2 heads, 1 handle, 1 ring	4453.00	3785.05
54-567-200-0	4—8" (100—200mm)	4 heads, 1 handle, 2 rings	7141.00	6069.85
54-567-210-0	.750"—4" (20—100mm)	6 heads, 1 handle, 4 rings	5527.00	4697.95
54-567-620-0	.250"—.750" (6-20mm)	5 heads, 1 handle, 3 rings	3066.00	2606.10

Connectivity Kits

Order No.	Description	
54-115-526-0	Proximity cable with USB connection	133.40
54-115-527-0	Proximity cable with serial connection	133.40
54-100-350-0	CR2032 Battery	5.70

Fowler-Bowers XTD3 Electronic Holemike Sets

Fowler-Bowers XTD3 Electronic Holemike bore gages offer extended travel with fixed anvils. The micrometer style ratchet system ensures a constant measuring force to eliminate operator "feel".

NEW!



54-367-050-0



- Larger (10mm) easier to read display
- Self centering heads
- USB connectivity, Bluetooth is available
- Four preset memories
- Fixed anvils
- Resolution: .00005" / .001mm
- Range .080"–12" (2–300mm)
- Tungsten carbide measuring faces on all 3-point heads from .5" (12.5mm) and up.
- Heads with special anvils available for threads, splines, slots, etc.
- Sizes over .500" (12.5mm) feature blind bore capability
- Setting rings included in all sets
- Includes UKAS certificates for all pistol grip, heads and rings
- Special anvils available
- **Contact the Fowler Technical Department for special anvil applications.**



 **Available with BLUETOOTH!**
Contact the Fowler Sales Department for more information.

Complete Range Sets

Order No.	Range	Includes	List Price	Sale Price
54-367-000-0	.080"–.250" (2–6mm)	5 heads, 1 handle, 3 rings	\$5739.00	\$4878.15
54-367-010-0	.250"–.375" (6–10mm)	2 heads, 1 handle, 1 ring	2154.00	1830.90
54-367-020-0	.375"–.750" (10–20mm)	3 heads, 1 handle, 2 rings	2547.00	2164.95
54-367-050-0	.750"–2" (20–50mm)	3 heads, 1 handle, 2 rings	3334.00	2833.90
54-367-100-0	2–4" (50–100mm)	3 heads, 1 handle, 2 rings	3730.00	3170.50
54-367-105-0	4–6" (100–150mm)	2 heads, 1 handle, 1 ring	3334.00	2833.90
54-364-110-0	6–8" (150–200mm)	2 heads, 1 handle, 1 ring	4453.00	3785.05
54-367-200-0	4–8" (100–200mm)	4 heads, 1 handle, 2 rings	7141.00	6069.85

Connectivity Kits

Order No.	Description	List Price
54-115-526-0	Proximity cable with USB connection	133.40
54-115-527-0	Proximity cable with serial connection	133.40
54-100-350-0	CR2032 Battery	5.70

Prices & Specifications are subject to change without notice.

LIFETIME WARRANTY



We are so confident that these Fowler-Sylvac products are the most accurate, most dependable, best made products you can buy, we are extending the warranty to last a lifetime!

*No Gimmicks
No Hurdles
No Nonsense*

Quality, accuracy, dependability, world-class customer service and now a real Lifetime Warranty!

Mark VI Electronic Indicators

- Robust construction
- Water and coolant resistant
- Protection class IP-67
- Repeatability: 2µm
- Output: Proximity/Power - USB/RS232/digimatic/Wireless
- Battery life: 10,000 hours of operation
- Menus customizable with free software
- Wide range of functions (MIN/MAX/DELTA, TOL, Factor, Preset, Auto Off, etc)
- Aluminum housing
- Bezel rotates 270°
- Large display with LED tolerance indicators
- Includes lug back

Save over 10%

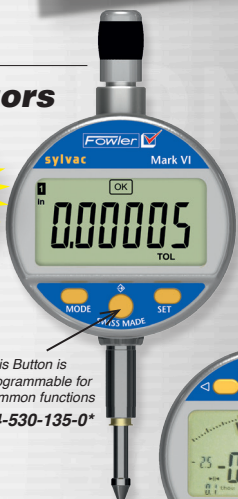

This Button is programmable for common functions
54-530-135-0*



54-530-535-0



Swiss Quality!



*Available with Bluetooth, contact the Fowler Technical Department for details.

Order No.	Description	Maximum Error	Resolution	List Price	Sale Price
54-530-125-0	0-.500"/12.5mm	0.0004"/.01mm	0.0005"/.01mm	\$422.30	\$365.70
54-530-135-0*	0-.500"/12.5mm	0.00012"/.003mm	0.00005"/.001mm	525.30	463.50
54-530-145-0	0-1"/25mm	0.0004"/.01mm	0.0005"/.01mm	482.00	422.30
54-530-155-0*	0-1"/25mm	0.00016"/.004mm	0.00005"/.01mm	576.80	514.00
54-530-175-0	0-2"/50mm	0.00019"/.005mm	0.00005"/.001mm	1091.80	896.40
Bluetooth					
54-530-335-0	0-.500"/12.5mm	0.00012"/0.003mm	0.00005"/.001mm	669.50	599.00
54-530-355-0	0-1"/25mm	0.00016"/.004mm	0.00005"/.001mm	715.90	640.00
Analog Display					
54-530-535-0	0-.500"/12.5mm	0.00012"/0.003mm	0.00005"/.001mm	607.70	485.00
54-530-555-0	0-1.00"/25mm	0.00016"/0.004mm	0.00005"/.001mm	664.40	530.00

ULTRATAST TEST INDICATORS

Horizontal Test Indicators

- Box-type housing opens on one side only.
- Bottom and side walls are one piece construction which encloses and protects the movement from shocks and damage.
- Self-contained movement
- Jeweled movement bearings, precision gears and pinions for maximum sensitivity and accuracy
- Satin-chrome finish is corrosion proof
- Stylus: ball diameter .080"/2mm
- Swivel range 220° on all models
- Includes 1/4" & 5/16" Dovetail clamps

**Reduced
over 60%**



52-568-005-0

Order No.	Reading	Measuring Range	Dial Diameter	Stylus Length	Measuring Force
52-568-005-0	.0005"	±.015"	1.083"	.453"	0.15N
52-568-010-0	.0005"	±.015"	1.50"	.453"	0.15N
52-568-015-0	.0001"	±.004"	1.50"	.453"	0.15N
52-568-022-0	.0005"	±.015"	1.083"	1.417"	0.07N

OVERSTOCK SPECIAL

Order No.	Description	List Price	Sale Price
52-568-005-0	UltraTast Horizontal Test Indicator	\$124.60	\$45.00
52-568-010-0	UltraTast Horizontal Test Indicator	141.60	45.00
52-568-015-0	UltraTast Horizontal Test Indicator	181.30	45.00
52-568-022-0	UltraTast Horizontal Test Indicator	202.80	45.00

HOLDXTEC[®] Holding Systems

- All accept 3/8" indicators
- Mag base and HOLD-TEC with fine adjust also accepts 8mm indicators
- All have dovetail clamps for test indicators
- Mag base features 2 fine adjusts making it a **6-Axis Mag Base**
- HOLD-TEC can be mounted in drill chucks, collets, dial gage stands with 8mm mount diameter to make a quick transfer stand
- Mag base has 180 lb. pull
- Adjust to any position
- Powerful On/Off mag base
- Central locking system



52-565-036-0
(Indicator not included)

52-565-038-0
(Indicator not included)



**Features
Double Fine Adjust**

52-585-085-0
(Indicator not included)

**MACHINIST GRADE!
For MAXIMUM Precision**

Order No.	Description	List Price	Sale Price
52-585-085-0	HOLD-Tec Mag Base with Double Fine Adjust	\$151.70	\$120.00
52-565-036-0	HOLD-Tec without Fine Adjust	85.20	68.00
52-565-038-0	HOLD-Tec with Fine Adjust	92.60	74.00

Prices & Specifications are subject to change without notice.

CHROME FLEX MAG SET

with **INDI-X Blue** Electronic Indicator or **AGD Black face Indicator**

Indi-X Blue Indicator features:

- Direct Inch/Metric Conversion
- 1" / 25mm travel
- Auto Off feature
- 2-1/4" dial face
- Lugback and 3/8" stem mountings
- Resolution .0005" / .01mm
- Tolerance indicators
- Absolute/incremental reading
- Floating zero
- Carbide tipped point

Included Magnetic Indicator Back for mounting to most metal surfaces!



TOOL-A-THON
BEST SELLER!
FOWLER HIGH PRECISION

Flex Arm Mag Base features:

- Corrosion resistant chrome plated flex arm
- 85 lb. pull magnet
- Holds rigidly in almost any position
- V-base for mounting on rounded surfaces

Magnetic Indicator Back features:

- Use for positioning indicator on most metal surfaces
- Protective coating

Save 30%

AGD Indicator features:

- AGD Group 2
- Dial diameter: 2-1/4"
- Travel: 1"
- Reading: .001"
- Continuous reading: .100"
- Carbide tipped point

All in a shop-hardened case.

See the Indi-X Blue on page 26!

Order No.	Description	List Price	Sale Price
54-585-100-0	Chrome Flex Mag and Indi-X Blue Electronic Indicator Set	\$237.90	\$165.00
52-585-500-0	Chrome Flex Mag and AGD Black Face Indicator Set	178.40	123.00

X-PROOF® Water Resistant Indicator Set

BEST VALUE!
IP54 Shockproof indicator available!



Magnetic Base (52-585-010-0):

- Fine adjustment
- Base dimensions: 2" x 2-11/32" x 1-13/16"
- Mounts test indicators with 1/4" post
- 85 lb. pull
- On-Off lever release magnet
- V-base for placing on round surfaces

X-Proof Indicator (52-520-450-0):

- Travel: 1"
- Reading: .001"
- Continuous reading: 0-100
- Tolerance markers
- AGD Group 2, 2-1/4" dia.
- Lugback and carbide point
- Robust, shockproof design
- Rubber bellows on stem
- O-ring seal on safety cap
- O-ring protection for bezel and rotating dial
- Sealed back plate

TOOL-A-THON
BEST SELLER!
FOWLER HIGH PRECISION



Protected to:
IP54
COOLANT & FLUID
RESISTANT

Save 15%

All in a shop-hardened case.

Order No.	Description	List Price	Sale Price
52-585-155-0	X-Proof Water Resistant Indicator Set	\$79.40	\$66.50

Articulating Mag Base and Indicator Combo

AGD Indicator

- 1" travel.
- Continuous reading: 0-100.
- Reading: .001"
- AGD group 2, 2-1/4" dial diameter.
- Revolution counter
- Tolerance markers
- Lug back mount
- Carbide point

Articulating Mag Base

- Adjust in practically unlimited positions
- Fine adjust
- 85 lb. pull
- V-slot on base for mounting on rounded surfaces.

**Set includes
shop-hardened case!**



Can be set up in almost unlimited positions!

Order No.	Description	List Price	Sale Price
52-585-150-0	NEW Articulating Mag Base & Indicator Combo	\$164.95	\$98.50
52-585-008-0	NEW Articulating Mag Base only	92.20	64.00

Indicator, Mag Base, Dial Caliper & Mic Set Combo

0—3" Micrometer Set (52-229-213-0)

- .0001" reading
- Carbide measuring faces
- Ratchet thimble and locking nut
- Microfine graduations
- Sizes over 1" include standard.
- Supplied in shop-hardened case.

Shockproof Dial Caliper (52-008-706-0)

- 4-way measuring
- Solid stainless steel construction
- Silky smooth movement throughout.
- .100" range per revolution.
- .001" reading dial face
- Tough shockproof design
- Supplied in shop-hardened case.

AGD Indicator (52-520-110-0)

- 1" travel
- Continuous reading: 0-100
- AGD group 2, 2-1/4" dial diameter
- Revolution counter
- Tolerance markers
- Lug back mount

Magnetic Base (52-585-010-0)

- 85 lb. pull
- Fine adjustment
- V-bottom base



Order No.	Description	List Price	Sale Price
52-229-780-0	Indicator, Mag Base, Dial Caliper & Mic Set Combo	\$341.00	\$210.00

Prices & Specifications are subject to change without notice.

Dial Bore Gage Sets with Carbide Anvils

Carbide anvils

- Easy-to-read
- Economical
- Graduation: .0005"
- Chrome plated handle
- Insulated grip
- Includes extension holder and fitted case



52-646-100-0



52-646-300-0

Order No.	Description	Range	List Price	Sale Price
52-646-100-0	Dial Bore Gage Set	.7—1.5"	\$143.30	\$106.30
52-646-300-0	Dial Bore Gage Set	2—6"	118.40	106.30

Extender 1.4" to 6" or 35mm to 160mm Dial Bore Gage Sets with Carbide Anvils

XTENDER

Industry's two most popular bore gage ranges combined in one set!

Carbide Anvils

- Easy-to-read
- Economical
- Graduation: .0005" or .01mm
- Insulated grip
- 1.4" to 6" range or 35 to 160mm
- Chrome plated handle
- Includes extension holder and fitted case



52-646-400-0



Order No.	Description	Graduation	List Price	Sale Price
52-646-400-0	Inch X-Tender Bore Gage Set	0.0005"	\$180.00	\$128.30
52-646-500-0	Inch X-Tender Bore Gage Set	0.0001"	225.00	183.30
52-646-220-0	Metric X-Tender Bore Gage Set	0.01mm	198.90	138.50

Extender-E Electronic 1.4" to 6" Dial Bore Gage Set

XTENDER-E

Industry's two most popular bore gage ranges combined in one easy-to-use ELECTRONIC set!

All the same benefits included in the X-Tender Dial Bore Gage are now available with an electronic indicator providing inch/metric reading capability. Preset size of master for absolute reading and minimum hold feature to lock on the bore size as the gage is rocked in the part to be measured.



Bore Gage Features:

- Range: 1.4"-6"/35mm-150mm
- Carbide anvils
- Easily adjustable
- Self-centering
- Includes extension holder
- Shop hardened case

Indicator Features:

- Dual reading inch/metric electronic indicator
- Bar graph and numeric digital display
- Resolution: .00005"/.001mm
- Preset with recall
- ABS/INC measurement
- Min/Max/TIR



For instructional video search "X-tender Bore Gage" at www.youtube.com

Order No.	Description	List Price	Sale Price
54-646-401-0	XTender-E Bore Gage Set	\$311.00	\$259.00
54-100-350-0	CR2032 Battery	5.70	

XTRA-RANGE® 4" to 12" Dial Bore Gage

- Carbide Anvils
- 4" to 12" range
- 10" measuring depth
- Easy-to-read
- Economical
- Graduation: .0005"
- Insulated grip
- Chrome plated handle.
- Includes 2 contact extensions



NEW!

Save 25%



Order No.	Description	List Price	Sale Price
52-646-600-0	NEW Xtra-Range Dial Bore Gage	\$213.40	\$159.70

Dial Cylinder Bore Gage

Save 10%

- Measure cylinder taper and out of roundness.
- Measure bore diameter to 8" depth
- Graduations: 0.001"
- Range: 2.6" to 7"
- Includes gage, contact extensions and indicator



NEW!



Order No.	Description	List Price	Sale Price
52-646-200-0	NEW 2.6" - 7" Dial Cylinder Bore Gage	\$151.80	\$136.50

Bore Gage Setting Master Kit - Inch & Metric

Fowler's Bore Gage Setting Master Kit is used for accurately setting any bore gage up to 6"/150mm in diameter to an accuracy of .0001"/.003mm.

Each Set includes:

Includes:
Bore gage setting master and gage block set.
All in a custom-fitted case!

Setting Device (53-646-000-1 - Inch Model)

- Base anvil: 3.950" x 1.050"
- Adjustable anvil 2.375" x .375" (two each)
- Internal capacity: 6"/150mm
- Depth capacity: 1"/25mm
- Centralizer capacity width: 2.750"
- Quick-release holder for fast adjustment
- **Can also be used for external setting, depending on application (external mics, snap gages, caliper gages)**

Economy Gage Block Sets

Inch model:

- 36 piece
- Tolerances to .00005"
- Certificate of Calibration to N.I.S.T.

Metric model:

- 33 piece
- AS-2 grade
- Certificate of Calibration to N.I.S.T.

NEW!



53-646-000-1

Order No.	Description	List Price	Sale Price
53-646-000-1	NEW HEAVY DUTY Inch Bore Gage Setting Master Kit	\$283.30	\$204.90
53-646-010-0	Standard Metric Bore Gage Setting Master Kit — SPECIAL PRICE!	303.90	\$195.00

Prices & Specifications are subject to change without notice.

mini-MAG Protractor™



Dimensions:
L: 2.375" x W: 1.375" x H: 2.375"

The mini-MAG Protractor provides instant 360° digital inclination display of any angle with the additional unique feature of embedded magnets on both sides and the bottom which make it ideal for a variety of measurements.

- Embedded magnets with 3.5lb. pull
- Uses standard 9V battery (250 hrs.)
- Measuring range: 360° (4 x 90°)
- Display automatically inverts
- Resolution: .05°
- Accuracy: ±.2°
- Repeatability: .05°
- Hold feature

**TOOL-A-THON
BEST SELLER!
FOWLER HIGH PRECISION**



Display inverts for easy reading!

Order No.	Description	List Price	Sale Price
54-422-450-1	Mini-Mag Protractor	\$92.20	\$72.70

Bevel Protractor with 6" & 12" Blades

- Magnifier for vernier scale
- Includes 6" & 12" blades and an angle attachment.
- Satin chrome finish for easy readings in 0-90° sectors.
- Graduation: 360° with 4, 0 - 90° quadrants
- Reading to 5 minutes with vernier.
- Includes fitted case.

**Save
35%**



Order No.	Description	List Price	Sale Price
52-440-612-0	Bevel Protractor	\$218.10	\$141.00

Fowler Digi-Pro Electronic Protractors

The Digi-Pro electronic protractor includes embedded magnets for unique measurement areas. On/Off, Zero, Hold and Reverse feature to invert the display for easier reading in certain situations.

- Embedded 25 lb. pull magnets
- Full, 360° measuring range
- Accuracy: ±.2°
- Repeatability: ±.05°
- Resolution: .05°
- Invertible display feature
- Voltage: Standard 3V lithium battery



**Save
over 20%**



USE THE DIGI-PRO TO MAKE FAST AND ACCURATE ANGULAR MEASUREMENTS!

Order No.	Description	List Price	Sale Price
54-440-740-1	4" Digi-Pro Electronic Protractor	\$85.00	\$64.70
54-440-775-1	12" Digi-Pro Electronic Protractor	101.90	69.80
54-100-350-0	CR2032 Battery	5.70	

12 Piece Angle Block Set

- Precision ground hardened steel.
- Blocks: 1/4°, 1/2°, 1°, 2°, 3°, 4°, 5°, 10°, 15°, 20°, 25° and 30°
- Angular accuracy : ± 30 arc seconds
- Set up angles quickly and easily
- All blocks 3" long x .25" thick
- Complete in shop hardened case



**Save
over 15%**

NEW!

Order No.	Description	List Price	Sale Price
52-666-777-0	NEW 12 pc. Angle Block Set	\$168.20	\$141.50

Sine Bars

Fowler Sine Bar equipment used with gage blocks is highly recommended for securing a high degree of accuracy in measuring angles for grinder and milling machine set ups. Both sine and rolls hardened and ground for extreme accuracy.

- Top surface is accurate to 0.00003" per inch of length. Parallelism: 0.0004"
- Flange on end of bars for resting work
- Sine bars have holes for mounting and clamping
- Includes fitted case



**Save
over 20%**



NEW!



Order No.	Description	Width	Distance between Center of Rolls	List Price	Sale Price
52-455-010-0	NEW 5" Sine Bar	15/16"	5" ± .0004"	\$131.40	\$105.00
52-455-015-0	NEW 10" Sine Bar	1"	10" ± .0004"	279.90	223.00
52-455-020-0	NEW 5" Sine Bar	2"	5" ± .0002"	188.10	140.00

Adjustable V-Block

A precision ground angle block that is ideal for drilling, milling, grinding and set-up tasks.

- Hardened and precision ground.
- 3.75" L x 1.75" W x 2" H and offers approximately 1.75" work space.
- Angle accuracy: ±10 sec.
- Squareness within .0002"
- Comes complete in deluxe fitted wooden case.
- Hardened to 50-55 HRC



**Save
over 15%**

NEW!

Order No.	Description	List Price	Sale Price
52-585-090-0	NEW Adjustable V-Block	\$236.70	\$195.50

V-Block Set

The Fowler Universal-type V-Block is a precise tool used for layout work in the tool room and has the capability of holding square or round workpieces with greater accuracy

- Two clamps, with screw hole at 90 degrees for positive clamping of work, are included.
- Clamping capacity=2"(50mm.)
- V-Blocks are constructed with stepped grooves which allow the clamps to be inserted without protrusion, thus allowing V-Blocks to be used on base, ends or sides.
- Hardened steel. All sides of V-Blocks precision ground parallel and square within .0004".
- Matched pair of V-Blocks are perfectly aligned with 90 degree V-grooves ground end and parallel to the sides and base.

Save over 25%



NEW Shop-Hardened Case!

Order No.	Height	Length	Width	List Price	Sale Price
52-475-555-0	2"	2-3/4"	2"	\$229.80	\$165.50

V-Block Set

- Parallel and square within .0003".
- Dimensions: L 1-3/8" x W 1-3/8" x H 1-3/16"
- Reversible swing-away clamps
- Ø capacity: .030" to 1.285"
- Versatile clamp plus unique offset hole pattern in top of blocks, offers a large variety of clamping possibilities.

Save 35%



NEW!

Order No.	Description	List Price	Sale Price
52-475-001-1	NEW V-Block Set	\$50.80	\$33.00

X-BLOX® V-Block Set

- 2 each @:**
- Dimensions: 1-1/2" L x 1-1/4" W x 1-1/4" H.
 - Work capacity: Approximately 1"
- 2 each @:**
- Dimensions: 2" L x 1-1/2" W x 1-1/2" H.
 - Work capacity: 1-1/2"

Save over 20%



- All feature:**
- Surfaces are square and parallel within .0005"
 - V-grooves are square and parallel with all surfaces within .0005"
 - Corresponding dimensions for each pair are alike within .0005"
 - All enclosed in shop-hardened case



Order No.	Description	List Price	Sale Price
52-475-500-0	X-Blox V-Block Set	\$113.90	\$87.60

1-2-3 & 2-4-6 Blocks



52-432-246-0

**Save
over 20%**

- 23 holes for easy clamping
- Sold in pairs
- Useful in layout & grinding work
- Accuracy: $\pm .0002"/1"$
- Matched accuracy: $\pm .0002"$

Order No.	Description	List Price	Sale Price
52-439-031-0	1-2-3 Blocks	\$87.10	\$57.50
52-439-246-0	2-4-6 Blocks	205.50	154.50

Steel 1-2-3 Blocks



**Save
over 40%**

- Tolerance: $.0001"$ (squareness per inch)
- Dimensions: $1" \times 2" \times 3"$
- Hardened to 58-60 Rockwell C.
- Matched accuracy within $\pm .0002"$

Order No.	List Price	Sale Price
52-439-001-0	\$133.20	\$75.20

Premium 1-2-3 Block Set

NEW!

**Save
15%**



- Hardened (HRC 55–60)
- 23 holes for easy clamping, 5 tapped, 18 untapped thru holes.
- Complete in a shop-hardened case.
- Surface finish: $6-16\mu$
- Includes hex wrench and 5 mounting bolts ($3/8"$ -16).

Order No.	List Price	Sale Price
52-439-032-0	\$79.90	\$67.00

Zirconia Ceramic 1-2-3 Block Set

**Save
20%**



NEW!

- Constructed of Zirconia Ceramic.
- Blocks feature a coefficient of expansion only $2 \times 10^{-6}/C^{\circ}$ different than steel blocks.
- Dimensions: $1" \times 2" \times 3"$
- Flatness within $.00004"$
- Size accuracy within $.0002"$

Order No.	List Price	Sale Price
53-439-101-0	\$288.40	\$225.00

1/8" Parallel Set

NEW!



- Ten pairs which are $6"$ in length and $1/8"$ thick
- Heights: $1/2"$, $5/8"$, $3/4"$, $7/8"$, $1"$, $1-1/8"$ and $1-1/4"$ — $1-3/8"$, $1-1/2"$ and $1-5/8"$
- Parallel within $\pm .0002"$ each pair
- Heights matched with $\pm .001"$ each pair
- Includes fitted case



Order No.	List Price	Sale Price
52-437-000-0	\$218.10	\$165.00

Adjustable Parallels

NEW!



- Each parallel has two dovetailed pieces that slide on each other and lock in position with set screws. Easily adjusted and set up to size with a micrometer. They can be quickly inserted in slots and expanded to size.
- Sizes: $3/8"$ - $1/2"$, $1/2"$ - $11/16"$, $11/16"$ - $15/16"$, $15/16"$ - $1-5/16"$, $1-5/16"$ - $1-3/4"$, $1-3/4"$ - $2-1/4"$
- Slot size determined by measuring the parallels externally with a micrometer

Order No.	List Price	Sale Price
52-437-006-0	\$132.00	\$115.00

Combination Square

- Blades are chrome plated, fully hardened and tempered,
- Square head has level and scriber point
- Double indexed protractor is graduated 180° in both directions
- 52-370-012-0 graduated in 8ths, 16ths, 32nds and 64ths
- 52-378-006-0 graduated in 30nds, 64ths, 50ths and 100ths



Order No.	Description	List Price	Sale Price
52-370-012-0	Square, Protractor and Center Head with 12" blade	\$177.50	\$133.70
52-378-006-0	2 piece combination square, includes square head and 6" blade	72.60	60.80

Protractors

Semi-Circular Head — 52-450-005-0

- Measures angles from 0—180 degrees.
- Used for drawing radial lines at any angle.
- Measures 3-5/16" in diameter and features a lock nut and 6" arm with knurled thumb lock nut.

Rectangular Head — 52-450-010-0

- Measures angles from 0-180 degrees.
- Used to transfer angles and to set bevels.
- 6" arm with knurled thumb lock nut.
- Made of chrome steel with satin finish.
- Measures 3-5/16" x 2". Rectangular head provides four working edges. Blade secured firmly at any angle by a lock joint and knurled nut.



Order No.	Description	List Price	Sale Price
52-450-005-0	NEW Protractor — Semi-Circular Head	\$44.00	\$32.00
52-450-010-0	Protractor — Rectangular Head	50.80	34.00

Edge Finder Set

Contains:

- 3/8" x .200" Edge Finder
- 1/2" x .200" Edge Finder
- 1/2" x .200" Combo Edge Finder
- 1/2" x .500" Edge Finder
- Complete in fitted case.



Order No.	Description	List Price	Sale Price
52-575-125-0	Edge Finder Set	\$47.10	\$37.50

Electronic Edge Finders

- Six equally spaced light ports provide visibility at any angle
- Made in the USA
- Edge finder lights instantly when stylus touches work edge
- Repeatability: .0002"
- Works on any conductive metal



Along with light indication, model #54-575-650-0 emits an audible "beep" at time of contact.

Order No.	Stylus	Shank	Audible	Battery	List Price	Sale Price
54-575-600-0	.200"	1/2"	NO	12 volt	\$30.80	\$23.50
54-575-625-0	.200"	1/2"	NO	12 volt	108.60	90.60
54-575-650-0	.400"	3/4"	YES	12 volt	108.60	90.60

RULES

EZ-Read Black Face Rules

- Hardened stainless steel
- White easy-to-read microfine graduations against a black, non-glare finish



52-297-006-0



**Save
over 10%**

52-330-006-0

Golden Rules

- Titanium coated for superior wear resistance
- Non-glare finish=RC80
- Scratch resistant microfine graduations with excellent clarity and contrast



52-299-006-0

GRADUATIONS

4R: 8ths, 16ths, 32nds, 64ths

5R: 32nds, 64ths, 10ths, 100ths

Satin Chrome Rules

- Tempered steel
- Non-glare
- Sharp, easy-to-read microfine graduations

RIGID STEEL RULES

Order No.	Finish	Size	Reading	List Price	Sale Price
52-330-006-0	Satin Chrome	6"	4R	\$10.90	\$8.90
52-337-006-0	Black	6"	4R	9.20	6.40
52-339-006-0	Golden	6"	4R	22.70	17.80
52-330-012-0	Satin Chrome	12"	4R	18.90	15.00
52-337-012-0	Black	12"	4R	18.90	11.00
52-339-012-0	Golden	12"	4R	43.50	34.80
52-340-006-0	Satin Chrome	6"	5R	10.50	7.80
52-347-006-0	Black	6"	5R	9.20	6.40
52-349-006-0	Golden	6"	5R	22.70	17.80
52-340-012-0	Satin Chrome	12"	5R	17.20	15.00
52-347-012-0	Black	12"	5R	18.90	11.30
52-349-012-0	Golden	12"	5R	43.50	34.80

FLEXIBLE STEEL RULES

Order No.	Finish	Size	Reading	List Price	Sale Price
52-295-006-0	Satin Chrome	6"	4R	\$10.50	\$7.30
52-297-006-0	Black	6"	4R	8.60	5.90
52-299-006-0	Golden	6"	4R	22.30	18.20
52-295-012-0	Satin Chrome	12"	4R	16.10	13.40
52-297-012-0	Black	12"	4R	13.20	10.20
52-299-012-0	Golden	12"	4R	40.00	32.10
52-300-006-0	Satin Chrome	6"	5R	10.80	7.30
52-307-006-0	Black	6"	5R	8.60	5.90
52-309-006-0	Golden	6"	5R	22.30	18.20
52-300-012-0	Satin Chrome	12"	5R	16.10	13.40
52-307-012-0	Black	12"	5R	13.20	10.20
52-309-012-0	Golden	12"	5R	40.00	32.10

6"/150mm Pocket Steel Rule



- Rounded edge prevents damage to shirt pocket
- Rule width: .470"
- Inch graduations are in 64ths
- Rule thickness: .021"
- Metric scale is in 1mm increments



Order No.	Description	List Price	Sale Price
52-380-100-0	6"/150mm Pocket Steel Rule	\$6.90	\$5.10

Prices & Specifications are subject to change without notice.

Thickness Gages

- Each leaf of the thickness gage made of fine tempered steel, hardened
- The exact thickness is marked on each leaf
- Steel case with lock nut
- Meets U.S. Federal Specifications



52-485-010-0

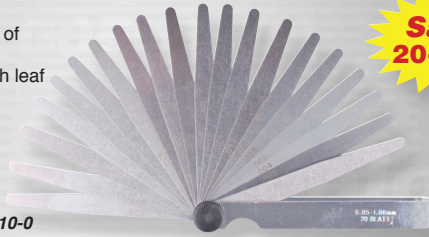

Save
20-40%

Order No.	Description	List Price	Sale Price
52-485-006-0	Tapered Thickness Gages-Inch.26 Leaf Set: .0015", .002", .0025", .003", .004", .005", .006", .007", .008", .009", .010", .011", .012", .013", .014", .015", .016", .017", .018", .019", .020", .021", .022", .023", .024" and .025". Length: 3".	\$15.40	\$12.30
52-485-010-0	Tapered Thickness Gages-Metric. 20 Leaf Set: 0.05mm, 0.10mm, 0.15mm, 0.20mm, 0.25mm, 0.30mm, 0.35mm, 0.40mm, 0.45mm, 0.50mm, 0.55mm, 0.60mm, 0.65mm, 0.70mm, 0.75mm, 0.80mm, 0.85mm, 0.90mm, 0.95mm and 1mm. Length: 100mm.	\$18.00	\$10.30

Screw Pitch Gages



Screw Pitch Gage 52-485-015-0

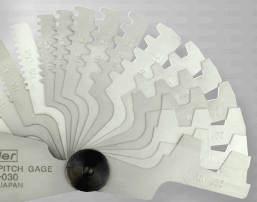

Acme Screw Pitch Gage 52-485-030-0

Screw Pitch Gages

- Narrow designed blades permit use for internal and external screw threads
- Locking device at each end to secure all blades for storage or position
- Correct pitch is determined by matching blade teeth with threads
- Precisely ground and finished
- Blades marked with thread size

Acme Screw Pitch Gage (29° angle)

- Made of fine stainless steel. Each blade is 3-1/2"/90mm long and .03"/.8mm thick

Order No.	Description	List Price	Sale Price
Inch Series 52-485-015-0	Screw Pitch Gage with 30 blades: 4 to 42 pitch standard V thread	\$10.80	\$8.20
Metric Series 52-485-020-0	Screw Pitch Gage with 24 blades: 0.25mm to 6.0mm	10.80	8.20
Acme Series 52-485-030-0	Acme Screw Pitch Gage with 16 blades (1, 1-1/3", 1-1/2", 1-3/4", 2, 2-1/2", 3, 3-1/2", 4, 5, 6, 7, 8, 9, 10 & 12 pitch)	95.90	79.00

Thread Measuring Wire Set

- Thread Measuring Wires include 48 wires in sixteen different sizes
- Accuracy for sizes .018" through .108" is within +0 / -.0004"; sizes .120" through .185" is within +0 / -.0005"
- Measures all U.S. 60° threads from 3-48 threads per inch
- Laminated conversion chart for 60° U.S and metric threads is included



Order No.	Description	List Price	Sale Price
52-485-048-0	Thread Measuring Wire Set: 48 Wires	\$28.80	\$20.60

Stereo Zoom Microscope

While the microscope is in focus, the magnification may be changed to suite the specimen. The zoom objectives of the instrument change the magnification continuously, covering a range of 7X—45X

NEW!



**Reduced
over 45%**

Note:
Contact the Fowler Technical
Department for reticles and
video components

53-640-740 with 53-640-778 (not included)

Stereo Zoom Microscopes are used in the electronics and precision machine industries for assembling and inspection of products. They are suitable for micrography and observation of fine structure of irregular bodies because of their high resolution and clear imaging within a broad field of view. They are also suitable for educational purposes in schools and hospitals and in agriculture, forestry, medical service, geology, archeology and biology fields.

Order No.	Description	List Price	Sale Price
53-640-778-0	NEW Deluxe Zoom Head with 10X eyepieces ONLY (for use with 53-640-740-0)	\$1074.00	\$590.00
53-640-740-0	NEW Universal Zoom Stand with top light for 53-640-778-0	496.16	309.00

Optical Comparator with Accessory Package

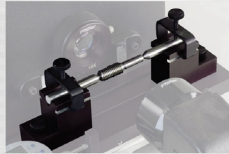
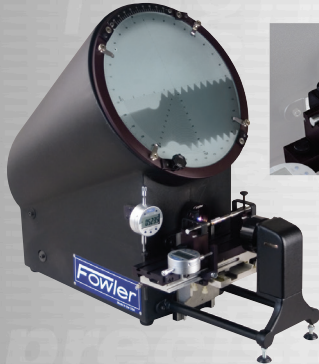

**Includes:
T-Slot V-Blocks
&
T-Slot Centers
shown**

The Fowler comparator is economically designed for basic comparative and absolute measurements and includes:

- 10X Lens
- 12" 1 Quadrant protractor screen
- T-slot stage with 6" horizontal travel and 2.5" vertical travel.
- 1 pair of t-slot mounted V-blocks
- 1 pair of t-slot mounted centers
- 2 Electronic AGD 2 Indicators:
1"/25mm capacity with .0005"/.01 resolution

**Save
over 20%**
53-900-100-0

Order No.	Description	List Price	Sale Price
53-900-100-0	Optical Comparator with Accessory Package	\$-2475.00	\$1850.00
53-900-000-0	12" Basic Bench Top Optical Comparator	2286.40	1750.00

Prices & Specifications are subject to change without notice.

43

Fowler

TOOL-A-THON

Volume 15.3

Transfer Punch Sets

- Punches are made of hardened and tempered tool steel, black oxide finished
- All sizes are marked and diameters are slightly undersized for easy handling
- Supplied with index stand

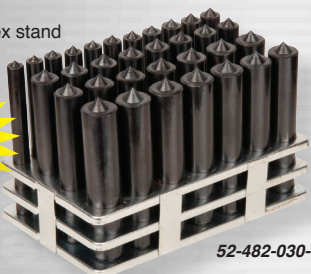

52-482-030-0



52-482-028-0

Order No.	Description	Range	List Price	Sale Price
52-482-028-0	28 Piece Transfer Punch Set	3/32"-1/2"	\$49.90	\$29.95
52-482-030-0	33 Piece Transfer Punch Set	1/2"-1"	87.60	58.00

XTRA-PUNCH[™] Heavy Duty Transfer Punch Set

- 1/2" - 1" range in 1/64"
- 36 piece set, 3 master punches and 33 individually sized sleeves
- Each sleeve and punch is clearly laser etched with its size
- Simply select the sleeve for the size required, place it on one of the master punches for that range and it is ready to use
- Punches and sleeve ranges are color coded for easy pairing
- Heavy duty for larger applications
- Punch tips are hardened 48-55 HRC
- Master punches are 4-7/8" in length and sleeves are 1" in length
- 1/4" the weight of a conventional transfer punch set with this range (approximately 4.5 lbs.)
- Supplied in a fitted, shop hardened case

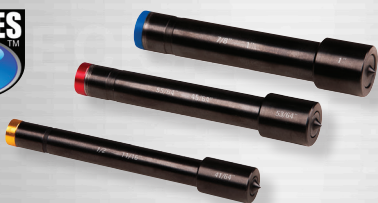

Order No.	Description	Range	List Price	Sale Price
52-482-040-0	NEW 36 piece Heavy Duty Transfer Punch Set	1/2" - 1" in 1/64"	\$84.50	\$71.00

Universal Transfer Punch



- Covers a large range with just 1 punch
- Spring loaded assures perfect hole center alignment
- Self centering
- Made of hardened tool steel

Order No.	Description	List Price	Sale Price
52-482-001-0	NEW 1/4" - 3/4" Universal Transfer Punch	\$9.80	\$8.20
52-482-002-0	NEW 1/4" - 11/16" Universal Transfer Punch	11.30	9.80

2 in 1 Scriber & Center Punch

- Contains a carbide tipped scriber and a steel center punch all in 1 tool
- Carbide tip is reversible for double the life
- Knurled finger grip
- 1/8" center punch tip
- Supplied with convenient pocket clip

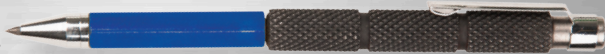

NEW!

← **Remove Scriber Tip To Access Center Punch Below!**



Order No.	Description	List Price	Sale Price
52-500-060-0	NEW 2 in 1 Scriber & Center Punch	\$9.30	\$7.00

Carbide Tipped Scriber Values!



- Lightweight
- Retractable carbide tip
- Knurled grip
- Machined aluminum body
- Pocket clip

Order No.	Description	Overall Length	List Price	Sale Price
52-500-050-0	Carbide Super Scriber	6.5"	\$32.00	\$27.60
52-500-055-0	Carbide Refill		9.80	



- Heavy duty
- Replaceable carbide tip
- Knurled grip
- Pocket clip
- Magnetic end cap

Order No.	Description	Overall Length	List Price	Sale Price
52-500-080-0	Replaceable Tip Carbide w/magnetic end cap	5.75"	\$8.90	\$5.90
52-500-085-0	Carbide Refill		1.80	



- Fine quality knurled steel handle
- Fully hardened point and blade

Order No.	Description	Overall Length	List Price	Sale Price
52-515-040-0	Cutter Scriber	6-1/2"	\$3.60	\$2.25

Super Heavy Duty Automatic Center Punch



- Handle constructed in steel. Four knurled bands provide a sturdy grip
- Moveable components are made from tool steel and hardened
- The point is easily removed for sharpening
- The pressure of marking is controlled by rotating the knurled cap. Screw the cap down for heavy indentations and screw the cap upward for lighter markings.

Save 30%

Order No.	Description	List Price	Sale Price
52-500-290-0	Super Heavy Duty Automatic Center Punch	\$20.40	\$14.10

Metal Etching Pen

A "must" for any tool room and machine shop for general marking purposes, Fowler's metal etching pen is used on copper, copper alloy, stainless steel, hardened steel tools and castings, etc.

Use it to initial personal tools. Its low-cost, disposable design offers limitless applications



Personalize your tools!

Order No.	Description	List Price	Sale Price
52-730-005-0	Disposable Felt Tip Metal Etching Pen, overall length is 6-1/4"	\$17.90	\$15.30

Prices & Specifications are subject to change without notice.

Z-HEIGHT -Jr. Electronic Height Gage

**Save
over 25%**



- Direct Inch/Metric Conversion
- Range: 6"/150mm
- Accuracy: .001"
- Resolution .0005" (.01mm)
- Large, high contrast LCD display
- Hold feature
- ABS/INC Measurement
- Floating zero
- Positive lock
- Carbide scriber

NEW!

Order No.	Range	List Price	Sale Price
54-175-006-0	NEW 6"/150mm	\$201.90	\$149.40
54-100-350-0	Replacement Battery	5.70	

Electronic Height Gage

An economical height gages that offers high quality, accuracy and durability.

- Large base for easy movement
- True inch/metric conversion
- Range: 0—20"/500mm
- Resolution: .0005"/.01mm
- Accuracy: ± 0.0025"
- Repeatability: .0005"/.01mm (±2s)
- Deluxe wooden case with reinforced metal edges
- Large easy to read LCD
- Non-glare chrome reading surface
- Overall height: 28"
- Beam thickness: 1.25 X .4"
- Presetable display



NEW!

**Save
over 15%**

Order No.	Range	List Price	Sale Price
54-106-020-0	NEW 20"/500mm	\$389.90	\$329.60
54-902-110-0	Replacement Battery	6.70	

Vernier Height Gages

**Save
over 30%**



- Adjustable main scale. Quickly "reset" zero or for easy reading without special calculations.
- Swing-away magnifier plus extra long vernier scales with wide separations in inch and metric.
- Fine adjustment mechanism.
- Carbide tipped scriber for direct reading over the full range.
- Satin-chrome finish for glare free reading. Raised lands prevent friction wear.
- Beam & slide of hardened stainless steel. Base and measuring surfaces all hardened tool steel, carefully ground and micro-lapped.
- Graduations: 0.001" and 0.02mm

NEW!

Order No.	Range	List Price	Sale Price
52-174-012-0	NEW 12"/300mm	\$288.40	\$199.00
52-174-024-0	NEW 24"/600mm	659.90	450.00
52-174-040-0	NEW 40"/1000mm	1456.00	995.00

Twin Beam Dial Height Gage

- Separate digit counters register both upward & downward travel.
- Zero setting can be obtained throughout the gage's range.
- Coarse readings in .100" graduations; fine readings taken on indicator are .001"
- Dual chrome plated beams.
- Carbide-tipped scriber.
- Base is hardened, ground & lapped for maximum flatness.

**Save
over 30%**



Accuracy	
52-174-212-0	±0.0015"
52-174-224-0	±0.002"

Order No.	Range	List Price	Sale Price
52-174-212-0	12"	\$344.90	\$236.90
52-174-224-0	24"	702.60	421.80

COAX-2D 2 Dimensional Coaxial Indicator Sets

Use the 2D Coaxial Set for accurate component centering and positioning in most machining applications. The 2D Coaxial indicator can be used at any angle and the dial remains stationary during the rotation of the machine spindle.

- Indicator assembly with 1.6" (42.5mm) diameter dial
- Graduations and revolution counter .0005" (.01mm)
- 3 Internal and 3 External feelers
- Center point feeler
- Restraining arm
- Complete in a fitted case

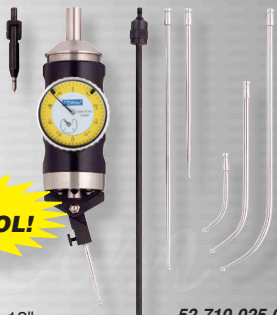

GREAT SHOP TOOL!

52-710-025-0

Specifications:

- Length: 6-7/8" (175mm)
- Shank: 3/8" dia. x 7/8" (10mm x 20mm) long
- Feeler ball: 1/8" (3mm) dia.
- Dial readings: 0-50
- Measuring range: .250" (6mm) axis offset
- Speed—recommended not to exceed approx. 800 RPM
- Locating accuracy to within .0002" (.005mm) of true center
- Capacity depends on feelers installed, but overall range is 5/32-12" (4-300mm) internal diameter; 0-12" (0-300mm) external diameter

Order No.	Description	List Price	Sale Price
52-710-025-0	2D Coaxial Set-Inch	\$229.80	\$173.80
52-710-030-0	2D Coaxial Set-Metric	234.30	173.80

Diamond File & Deburring Set

- 1 handle, providing maximum grip comfort.
- 5 piece set of diamond impregnated files consisting of a round, flat, square, triangle and half-round file, 5-1/2" long with 2-1/2" length of cut.
- 2 triangular scraper/deburring tools (single and double ended).
- Fitted storage case.

Reduced 60%

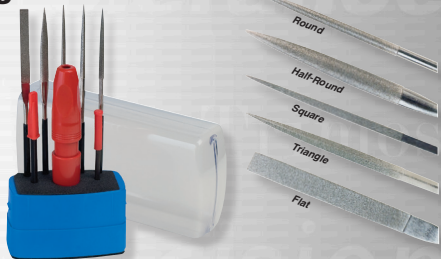

Order No.	Description	List Price	Sale Price
52-483-666-0	NEW Diamond File & Deburring Set	\$68.00	\$27.00

Rapid Burr

- "Quick-change" thumb operated button for instant removal, insertion and locking of new blades.
- Supplied with a blade for steel and aluminum.
- Unique rounded head blade for safe deburring of drilled and machined holes, end milled areas, tubing, backside of holes and an almost unlimited amount of uses.
- Curved blades swivel freely to automatically follow shapes, contours and holes.
- Adapts to all S-blades
- Molded to comfortably fit the user's hand without slippage or fatigue.

Save 40%



Order No.	Description	List Price	Sale Price
52-483-025-0	Rapid Burr	\$6.70	\$3.75

3 Piece Deburring Cutter Set

- Most economical
- 3 deburring tools
- Blades are replaceable
- 3 different blades from heavy duty to extra fine.

Save 15%

for brass & cast iron

for steel & aluminum

for plastic

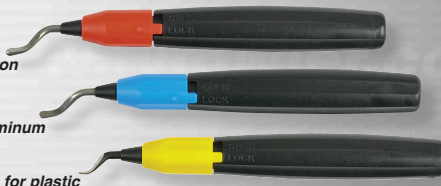

Order No.	Description	List Price	Sale Price
52-483-555-0	3 piece Deburring Cutter Set	\$11.80	\$9.00

Prices & Specifications are subject to change without notice.

X-PRO™



- Small, compact size
- 2 selectable parameters: Ra and Rz
- Large LCD display
- Meets ISO and DIN standards
- N.I.S.T. traceable specimen included
- Uses 9 volt battery (approx. 3000 measurements)
- Includes fitted case



54-410-500-0

**Reduced
10%**

The X-Pro Portable Roughness Tester II can be used for many applications by selecting from a variety of accessories, including:

- Stand with swivel
- A variety of probes

For certain Applications, RS232 is available on certain models (contact the Fowler technical department for more information)

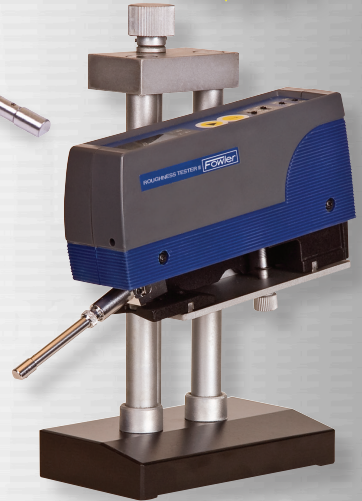

(X-Pro shown with optional stand with swivel)

X-Pro Portable Roughness Tester II

Order No.	Description	List Price	Sale Price
54-410-500-0	Portable Surface Roughness Tester .0004" probe (NIST specifications)	\$1693.80	\$1499.00
54-410-600-0	Portable Surface Roughness Tester .0002" probe (DIN specifications)	1693.80	\$1499.00

X-Pro Portable Roughness Tester II Stand with Swivel

Order No.	Description	List Price
54-400-896-0	Stand with Swivel Attachment	\$407.90

X-Pro Portable Roughness Tester II Probes and Accessories

Order No.	Description	Resolution	List Price
54-400-319-0	General Purpose Probe	.0004"	\$564.20
54-400-326-0	General Purpose Probe	.0002"	564.20
54-420-321-0	Small Bore Probe	.0004"	736.50
54-420-327-0	Small Bore Probe	.0002"	736.50
54-420-301-0	Traverse Chisel Probe	.0004"	736.50
54-420-302-0	Parallel Chisel Probe	.0004"	736.50
54-420-328-0	Groove Bottom Probe	.0004"	736.50
54-420-120-0	AC Adapter Kit		62.30

Fowler-Wyler Clinotronic Plus

The Fowler-WYLER Clinotronic Plus is an electronic level with unsurpassed versatility. It is economically priced, uses a specially designed microprocessor and the well-proven WYLER inclination sensor.

Features:

- Range of $\pm 45^\circ$, capacity of 0-360°
- Resolution of 0.01° (selectable)
- Adjustable base length
- Built-in calibration program
- Uses standard 1.5v AA batteries
- Automatic setting of zero by push button command
- Absolute or relative measuring mode
- Seal-tec technology for excellent performance even in difficult environmental conditions
- Interface connection RS232 is integrated. Special purpose cables available
- Low battery indication
- No loss of calibration data by power failure
- Price includes fitted case

Save
\$200



Swiss Quality!



The following measuring units may be selected:

Deg/Arcmin	00° 00'
Arcmin / Arcsec	00' 00"
GON / Neugrad (2 Dec)	00.00 gon
GON / Neugrad (4 Dec)	0000 gon
mm / rel.Basis (2 Dec)	00.00 mm/m
mm / rel.Basis (4 Dec)	0000 mm/m
Inch / rel.Basis (4 Dec)	0.0000"/10"
artillery per mille A‰	0000
mm / m (2 Dec)	00.00 mm/m
Inch / 10 Inches	0.0000"/10"
Inch / 12 Inches	0.0000"/12"
Milliradian	00.00 mrad (2Dec)
Milliradian	0000 mrad
Deg (2 Dec)	00.00 °
Deg (4 Dec)	0.0000°

Technical Specifications:

- Measuring range/capacity: $\pm 45^\circ/0-360^\circ$
- Response time: value available within 5 seconds
- Repeatability: $<.01^\circ$
- Linearity: within 3 min. of arc
- Temp. coefficient: less than $0.01^\circ/\text{C}$
- Data output: Serial
- Housing: aluminum hard anodized.
- Dimensions: 4 x 3 x 1" (100 x 75 x 30mm)

Order No.	Description	List Price	Sale Price
54-635-601-0	Clinotronic Plus	\$1931.30	\$1725.30
54-635-432-0	RS-232 Cable and Adaptor	466.50	
54-635-525-0	USB Connect Cable	286.30	

Portable Durometers

Fowler's Portable Durometers are just right for testing the hardness of flexible materials such as rubber and plastics. These gages conform to shore scales.

- Manufactured in accordance with DIN, ASTM, ISO and JIS specifications
- Includes reference test block, operating instructions and fitted case

NEW!

Applications:

35° Blunt Taper Durometers are suitable for testing soft and natural rubber products, neoprene, polyesters, soft PVS, leather, thiokol, nitril rubbers, wax, felt and more.

Sharp 30° point Durometers are ideal for testing hard rubber, hard synthetic materials, e.g. acrylics, glass, polystyrol, thermoplastics, printing rolls, vinyl sheets, cellulose acetates, densified wood, etc.



Save
over **10%**

Order No.	Penetrator	Shore Scale	List Price	Sale Price
53-762-301-0	NEW Blunt taper 30°	A	\$126.00	\$110.00
53-762-302-0	NEW Sharp 30°	D	145.00	125.00

Prices & Specifications are subject to change without notice.

SHOP-BLOX®

Rectangular Gage Block Set

- Manufactured to meet Federal Specification ASME B89. 1.9 - 2002 tolerances on length for inch gage blocks
- Certificate of Calibration traceable to N.I.S.T.
- Tolerances to $\pm 0.0005''$
- In high-quality fitted wood case



Save over 30%



**TOOL-A-THON
BEST SELLER!
FOWLER HIGH PRECISION**

53-672-081-0

Order No.	Description	List Price	Sale Price
53-672-036-0	36 piece Economy Rectangular Gage Block Set	\$283.30	\$195.70
53-672-081-0	81 piece Economy Rectangular Gage Block Set	498.50	339.90

Grade Ø Rectangular Steel Gage Block Sets

- Grade Ø
- Certificate of Calibration traceable to N.I.S.T.
- Each block is individually serialized
- Sizes clearly marked on each block
- Complete with fitted wooden case

Save over 30%

53-670-038-0



Order No.	Description	List Price	Sale Price
53-670-038-0	36 piece Grade Ø Rectangular Gage Block Set	\$447.60	\$310.00
53-670-080-0	81 piece Grade Ø Rectangular Gage Block Set	823.70	566.50

CERTIFIED SPACE-BLOX®

NEW!

- 36 blocks.
- Manufactured to meet Federal Specification ASME B89. 1.9 - 2002 tolerances on length for inch gage blocks. Certificate of Calibration traceable to N.I.S.T.
- Tolerances to $.00005''$
- Ground, hardened and tapped.
- 4 connection screws included.
- Includes shop hardened fitted case.



Save 25%



Order No.	Description	List Price	Sale Price
53-680-050-0	NEW Space-Blox	\$198.30	\$148.00

Steel Squares & Sets

- Made of the finest carbon tool steel, these economy squares have true right angles both inside and outside
- Beams and blades ground and lapped for straightness and parallelism
- Hardened blade
- Beam grooved at inner corner for clearance of burrs and dirt
- Squareness of blade edge to the working face: 2" & 3" = ± 0.0006 " , 4" & 6" = ± 0.0008 " , 9" & 12" = ± 0.0012 "



Fowler

TOOL-A-THON

Volume 15.3

Blade Size	Beam Size
2"	1.5"
3"	2.5"
4"	3"
6"	4"
9"	6"
12"	8"

Sets come complete in a "Shop Hardened" molded case!



52-432-246-0

Order No.	Size/Description	List Price	Sale Price
52-432-444-0	3 Piece Square Set: 2", 4" & 6" with shop hardened case	\$57.20	\$49.20
52-432-246-0	4 Piece Square Set: 2", 3", 4" & 6" with shop hardened case	68.10	55.60
52-432-469-0	4 Piece Square Set: 4", 6", 9" & 12" with shop hardened case	114.30	105.80
52-432-004-0	4" Square only	20.60	17.50
52-432-006-0	6" Square only	22.90	18.80
52-432-009-0	9" Square only	45.80	39.70
52-432-012-0	12" Square only	77.80	66.40

Cylindrical Squares

- Used for checking squares, height gages and other instruments
- Hardened and the ends are lapped to 90° angular accuracy
- 6" cylindrical squares: ± 0.001 "
- 12" cylindrical square: ± 0.0015 "
- Includes handles and wood case

52-750-006-0

52-750-012-0



Save 10%

Order No.	Description	List Price	Sale Price
52-750-006-0	6" cylindrical square	\$180.30	\$160.00
52-750-012-0	12" cylindrical square	257.50	230.00

Prices & Specifications are subject to change without notice.

Tool Master Lite Tool Presetter

Fowler's **NEW** Tool Presetter Stand for maximum productivity with ultimate user-friendliness. Tool Master Lite is a simple and user friendly presetter.

Introductory Offer 15% off

NEW!



- User friendly
- Swiss quality
- Reduces setup times
- Measures all types of tooling
- No connection to power or compressed air needed
- Needle bearing tool pot can be used with various adaptors, contact Fowler's technical department for details
- Easy to use digital display for each axis
- High concentricity needle bearing tool pot
- Maximum measuring repeatability
- Smooth ball bearing guides

Technical Data

Measuring Range	X axis 9.8"/250mm, Z axis 11.8"/300mm
Accuracy (X and Z)	.0008"/.02mm
Fine Adjustment	X axis
Tool Mounting	Needle bearing SK 50 - standard
Measuring Method	Contact
Dimensions	420 x 150 x 590mm
Weight	23 kg
Power	Battery (AA type)



Tool Pot Adaptors are available. Contact the Fowler Technical Department for more information

Order No.	Description	List Price	Sale Price
54-188-777-0	NEW Tool Master Lite Tool Presetter	\$6998.90	\$5940.00

Hi_Cal Height Gages

- Extra low measuring force, from 0.2N
- Measurement of internal and external diameters, centerlines, heights, widths, depths, surfaces
- MIN/MAX/TIR capability
- Excellent repeatability thanks to the motorized carriage
- Intuitive functions/minimizes key strokes
- Great mobility
- High reliability
- Data output USB and RS-232
- Battery life: 40 hours rechargeable during operation
- Touch sensitive probe speed for easy operation
- Base with small footprint

Includes: protective cover, charging set, ruby ball probe Ø3mm, setting gage and calibration certificate.

NEW
17.5"/450mm Model

10% off
Probe Sets

TOOL-A-THON
BEST SELLER!
FOWLER HIGH PRECISION

54-931-300-0



Save
\$400



Swiss Quality!



Order No.	Range	Accuracy	List Price	Sale Price
54-931-150-0	6"/150mm	0.00013"/.0034mm	\$4570.10	\$4158.10
54-931-300-0	12"/300mm	0.00016"/.0042mm	5252.00	4840.00
54-931-450-0	NEW 17.5"/450mm	0.00020"/.005mm	5499.00	5099.00
Accessories				
54-930-215-0	Full Probe Accessory Set		1072.50	965.00
54-930-217-0	Basic Probe Accessory Set		582.00	520.00

Hi_Gage One

The Fowler-Sylvac measuring system is exceptionally fast (60" per second traverse) and is the most reliable and maintenance free system ever created for measurement

- True inch/metric conversion
- Resolution: .0005"/.01mm
- Repeatability: .0004"/10µm
- Base size: 5.6" wide x 6.8" length
- Accuracy .0016"/.002"
- Includes scriber/measuring probe
- Direct RS-232 output
- **Scale not affected by oil, dust, chips, magnetism, shock, etc.**

Save
over 10%

***Receive a FREE 8mm Ball Probe with Purchase!**



Swiss Quality!

GREAT
SHOP GAGE!

54-212-024-1



Order No.	Range	List Price	Sale Price
54-212-016-1	16"/400mm	\$1426.60	\$1261.80
54-212-024-1	24"/600mm	1776.80	1441.00
Cables			
54-115-526-0	Proximity Cable with USB Connection	133.40	
54-115-527-0	Proximity Cable with Serial Connection	133.40	

Prices & Specifications are subject to change without notice.

53

Fowler

TOOL-A-THON

Volume 15.3

Fowler-Trimos V3, V4 & V5 Electronic Height Gages

The **NEW** Fowler-Trimos V3, V4 and V5 vertical measuring instruments have been developed for the most difficult workshop environments. Manufactured in their entirety in Switzerland, they guarantee a robust, precise and reliable product in the long run.

- Measuring ranges 400mm, 700mm and 1100mm
- Extremely easy to use
- "Black mask" display with user friendly functions
- Electronically adjustable measuring force 0.75/1.5 (N)
- Battery life: approximately 40 hours (lithium-ion batteries)
- Vast range of accessories
- All adjustments possible without tools
- Cast iron base for optimal stability
- RS232 and USB interfaces
- Air cushion (V4 and V5 Only)
- Dual probe holders (V4 and V5 Only)
- Carriage displacement: Manual
(V5 includes selectable manual or motorized carriage displacement)
- Measures heights, diameters, perpendicularity, centerlines, Min/Max/Delta
- Accessory measuring probes up to 340mm in length available and provide excellent repeatability
- Resolution: 0.00005"/0.001mm
- Repeatability (2s): 0.00008"/0.002mm (Ø 0.00016"/0.004mm)

Up To 10%

54-191-440-0



All V Models Include:

- Charging unit
- Measuring insert with ruby ball Ø4mm
- Probe holder elbow Ø 8mm
- Setting gage
- User's manual
- Test certificate

NEW!

V3	54-192-340-0	54-192-370-0
Measuring Range	16"/407mm	28"/711mm
Range with Probe inverted	20"/508mm	31.9"/812mm
Max. Permissible Errors	0.00032"/0.008mm	0.00032"/0.008mm
Frontal Squareness Deviation	0.0004"/0.010mm	0.0006"/0.015mm
Air Cushion		NO



V4	54-191-440-0	54-191-470-0
Measuring Range	16"/407mm	28"/711mm
Range with Probe inverted	28.3"/719mm	40.2"/1023mm
Max. Permissible Errors	0.0002"/0.005mm	0.00028"/0.007mm
Frontal Squareness Deviation	0.0004"/0.010mm	0.0006"/0.015mm
Air Cushion		YES



Save 5% Probe Sets

V5	54-199-540-0	54-199-570-0	54-199-590-0
Measuring Range	16"/407mm	28"/711mm	43.7"/1100mm
Range with Probe inverted	28.3"/719mm	40.2"/1023mm	56"/1422mm
Max. Permissible Errors (µm)		2.5 + L(mm)/300	
Frontal Squareness Deviation	0.0002"/0.005mm	0.00032"/0.008mm	0.00043"/0.011mm
Air Cushion		YES	

Order No.	Description	Range	List Price	Sale Price
54-192-340-0	NEW V3 Height Gage	16"/407mm	\$4281.00	\$3950.10
54-192-370-0	NEW V3 Height Gage	28"/711mm	4720.00	4356.90
54-191-440-0	NEW V4 Height Gage	16"/407mm	5639.00	5206.70
54-191-470-0	NEW V4 Height Gage	28"/711mm	6560.00	6056.40
54-199-540-0	NEW V5 Height Gage	16"/407mm	6215.00	5570.00
54-199-570-0	NEW V5 Height Gage	28"/711mm	7365.00	6600.00
54-199-590-0	NEW V5 Height Gage	43"/1100mm	11393.00	10200.00
Probe Sets				
54-199-105-0	21 pc. Micro Probe Set		1647.00	1547.00
54-199-106-0	16 pc. Macro Probe Set		1229.00	1129.00
54-199-107-0	7 pc. Economy Probe Set		324.00	307.80

Fowler-Trimos THV SPECIAL

The Fowler-Trimos innovative horizontal instrument that fulfills current quality requirements for many applications.



Multiple accessories ensure versatile applications for checking all types of gages such as plug gages, ring gages, thread plug gages, lever dial indicators, etc. as well as precision manufactured parts. Measuring range 2" and application range 4".

High accuracy is guaranteed by perfect instrument construction and the Heidenhain measuring system. The simplicity of the instrument and its ease of use allows precise and quick performance of all measurements. Adjustable Measuring Force is suitable for measuring thread members utilizing the 3 wire method.

Specifications:

Overall Application Range	Using standard probe
External measurement	0 - 4" /0 - 100mm
Internal measurement	.4 - 4" /10 - 100mm
Scale Range (travel)	Absolute display over 2"/50mm
Max. Measuring Band Error	0.000016"/4µm reference
Temperature 20°C	
Resolution on Heidenhain ND 287	0.00001", 0.000001"
Repeatability	0.000005" ±2s (. 1µm)
Adjustable Measuring Force	0 to 12N (0-40 oz.)

**Save
over 15%**



Package 1 includes

Part No.	Description	List Price
54-198-558-0	THV w/floating table	\$17,163.90
54-198-115-0	Measuring Table for Plug Gages	5,665.00
54-198-110-0	Display Unit Quadra Check	3,330.00

Package 2 includes

Part No.	Description	List Price
54-198-508-0	THV w/standard table	\$13,682.50
54-198-115-0	Measuring Table for Plug Gages	5,665.00
54-198-110-0	Display Unit Quadra Check	3,330.00

Description	List Price	Sale Price
THV Package 1	\$26,158.90	\$21,685.00
THV Package 2	22,677.50	18,662.00

Fowler

HIGH PRECISION
www.fowlerprecision.com



Find us on social media!



Fowler High Precision



Fowler_Co



Fowler High Precision



FowlerVid