

**COVEYA**

COVEYA.CO.UK



The **right** conveyor to  
get **your** job done

## The Coveya team has over **30 years' experience**

designing, manufacturing, supplying, maintaining and servicing market-leading conveyor systems for a vast range of industries and applications. Coveya is one of the most respected conveyor sales and rental companies, working with customers throughout the UK and worldwide.

Over the past 30 years we've been proud to work with...

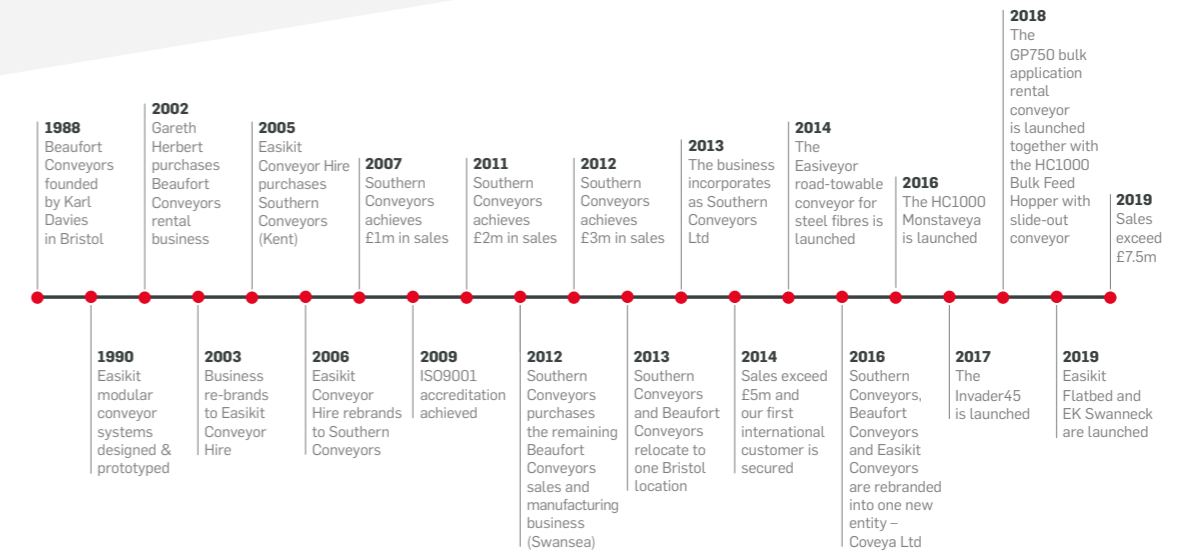

### WE ARE PASSIONATE ABOUT THE QUALITY OF THE PRODUCTS WE PROVIDE AND THE SERVICE WE DELIVER

We are dedicated to helping our customers fast-track their onsite material movements and cut down project timescales, enabling significant improvements to safety and efficiency, especially in challenging situations. We can also provide bespoke conveyors that meet specific site requirements.

We offer advice on the best conveyor to use for your specific application, free site visits, full installation and a 100% money back guarantee if a conveyor fails. With a dedicated sales team to help you through every stage of your conveyor rental or purchase, Coveya is committed to adding value and delivering more.

#### DISTRIBUTORS

Coveya is delighted to work with a number of international distributors that supply a range of our market leading conveyors for purchase or hire. We also supply conveyors to plant hire companies throughout the UK and further afield. If you would like to find out more about becoming a distributor of Coveya products, give us a call.

### WE ARE EXPERTS IN SUPPLYING CONVEYORS WITHIN A RANGE OF SECTORS

- Aggregates
- Construction
- Excavation
- Demolition & Remediation
- Factories & Warehouses
- Landscaping & Groundworks
- Rail, Ballast & Tunnelling
- Recycling & Waste Management
- Water Treatment & Reservoirs

T. 0800 915 9195

E. [sales@coveya.co.uk](mailto:sales@coveya.co.uk)

W. [www.coveya.co.uk](http://www.coveya.co.uk)

[@wekeepyoumoving](https://twitter.com/wekeepyoumoving)

[linkedin.com/company/coveya](https://www.linkedin.com/company/coveya)

## Coveya Product Range

PRODUCT	BUILDING & CONSTRUCTION	RECYCLING	LANDSCAPE & GROUNDWORKS	DEMOLITION & REMEDIATION	RESERVOIR MAINTENANCE	RAIL	BASEMENT EXCAVATION	AGRICULTURE	COMPOSTING & BIOMASS	WATER TREATMENT & RESERVOIRS	READY MIX CONCRETE ADDITIVE	FACTORIES & WAREHOUSES	AGGREGATES	SEWAGE & SLUDGE	CAPACITY	HIRE	BUY	PAGE
Invader 45™	✓	✓	✓	✓	✓	✓	✓	✓					✓		<50tph	✓	✓	<b>6</b>
Easikit™ 450	✓	✓	✓	✓	✓	✓	✓	✓	✓				✓		<50tph	✓	✓	<b>8</b>
Easikit™ 600	✓	✓	✓	✓		✓	✓	✓	✓	✓			✓		<100tph	✓	✓	<b>10</b>
Easikit™ 900	✓	✓				✓		✓	✓				✓		<125tph	✓	✓	<b>12</b>
Easikit™ 1200		✓						✓	✓				✓		<200tph		✓	<b>14</b>
Easikit™ 1500		✓						✓	✓				✓		<300tph		✓	<b>16</b>
The Easiveyor™								✓			✓		✓		<50tph	✓	✓	<b>18</b>
Easikit™ Mobile		✓				✓		✓	✓				✓	✓	from <100tph using EK600 to <200tph using EK1200	✓	✓	<b>20</b>
Easikit™ Radial		✓						✓	✓				✓	✓	from <100tph using EK600 to <200tph using EK1200	✓	✓	<b>22</b>
Easikit™ Flatbed		✓													from <100tph using EK600FB to <300tph using EK1500FB		✓	<b>24</b>
The Easibelt™		✓						✓				✓					✓	<b>26</b>
The Easitrack™		✓						✓				✓			<500kg load per roller		✓	<b>27</b>
HC1000 Monstaveya™		✓		✓		✓		✓	✓						<500tph	✓		<b>28</b>
The GP750		✓		✓		✓		✓	✓						<300tph	✓		<b>30</b>
Bulk Feed Hopper FH510		✓		✓				✓					✓		15m³ bulk capacity	✓	✓	<b>32</b>

# Invader 45™

Hire ✓ Buy ✓

Designed for mobility, power and ease of use, our unique ‘plug and play’ conveyor provides an immediate solution. It’s really easy and quick to set up and move around site with its optional wheeled undercarriage.

The Invader 45™ is extremely reliable (with 99% trouble-free rental across 9,000 rental days), low maintenance, economical to run and has been designed to eliminate downtime.



## PRODUCT FEATURES



SPECIFICATIONS	
Industry	Building & Construction, Recycling, Landscaping & Groundworks, Demolition & Remediation, Reservoir Maintenance, Rail, Basement Excavation, Agriculture, Aggregates
Power supply	110V
Type of material	Aggregate, Small rubble, Soil
Loading method	By hand, Small machine, Wheelbarrow
Mobile or static	Mobile, Static
Length	4m or 6m
Weight	160kg or 200kg
Belt width	450mm
Belt speed	0.75m/s
Maximum throughput	50 tons p/h
Hopper size (if used)	650 x 800mm
Max. incline angle	40°
Belt load	200kg
Motor power	1.5kW
Max discharge height	2525mm or 3715mm

## WHAT OUR CUSTOMERS SAY

"I have had six Invaders on hire for six weeks and haven't had a single phone call. We've never had a hire like this with any other conveyors".

Depot Manager,  
Plant Hire (London)

"For larger jobs and demolition works, I put the Invaders out because they just don't give me any problems."

Depot Manager,  
Tool Hire Company

"It's saved me thousands of man-hours. It's the best bit of kit we've ever had on this site!"

Site Supervisor,  
Construction Company



# Easikit™ 450

Hire ✓ Buy ✓

The Easikit™ 450 is a simple and compact modular system with a large capacity, which is perfect for low volume material handling. Its robust design supports the removal of rubble and light hard core and it also has a detachable feed hopper.



SPECIFICATIONS	
Industry	Building & Construction, Recycling, Landscaping & Groundworks, Demolition & Remediation, Reservoir Maintenance, Rail, Basement Excavation, Agriculture, Composting & Biomass, Aggregates
Power supply	110V or 415V
Type of material	Aggregate, Small rubble, Soil
Loading method	By hand, Small machine, Wheelbarrow
Mobile or static	Static
Length	Up to 20m
Weight	Variable 50kg/m
Belt width	450mm
Belt speed	0.9m/s
Maximum throughput	50 tons p/h
Hopper size (if used)	630 x 800mm
Max. incline angle	45°

SECTIONS	L (mm)	W (mm)	H (mm)	Kg
Head Unit (no motor)	960	960	310	53
Base tension unit	1190	1190	310	72
1m section	1050	1050	310	35
2m section	2050	2050	310	65

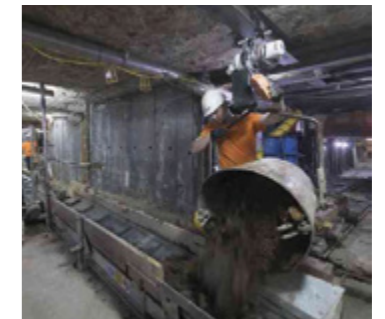

## CASE STUDY

### Claridge's Basement Excavation

When McGee Group agreed to build a 5-level basement underneath Claridge's Hotel in London, while keeping the hotel open for business, the Easikit 450 was the first choice. The new basement will house a gym, swimming pool, restaurant, retail space, meeting rooms and hotel services, as well as allowing the relocation of plant rooms at the top of the hotel to free-up space for 40 new bedrooms.

- 100s of tons of material moved each day through a 2m x 2m opening
- Easikit™ 450 and Easikit™ 600
- Operating up to 21 hours a day for over 2 years
- 6,000 sq. m of new floorspace to be created underneath the hotel

# Easikit™ 600

Hire ✓ Buy ✓

The Easikit 600™ can be used across a range of sites including large excavation projects due to its considerable output and ease of loading by machine.



SPECIFICATIONS			
Industry	Building & Construction, Recycling, Landscaping & Groundworks, Demolition & Remediation, Rail, Basement Excavation, Agriculture, Composting & Biomass, Water Treatment & Reservoirs, Aggregates	Weight	Variable 70kg/m
Power supply	415V	Belt width	600mm
Type of material	Aggregate, Rubble, Small rubble, Soil, Dewatered sewage	Belt speed	0.2m/s – 1.2 m/s
Loading method	By hand, Excavator, Small machine, Wheelbarrow	Maximum throughput	100 tons p/h
Mobile or static	Static	Hopper size (if used)	785 x 850mm or 940 x 940mm
Length	Up to 40m	Max. incline angle	35°



## CASE STUDY

### Keeping Network Rail on track

The platform at Liverpool's Lime Street Station was being lengthened for new trains. Old tracks had to be ripped up and moved and two disused service tunnels lay in the way of the new track routes. Spoil from the platform extension was moved into the tunnels but it flooded, therefore the pile of excavated sand on the track side was able to be efficiently moved to avoid a major project delay.

- Two exposed tunnels too weak to allow heavy plant to cross them
- Material needed to be moved 20m over the tunnels to avoid disrupting normal station activity
- 3 x Easikit™ 600 conveyors (6.4m each) with custom-made wheeled frames and a silenced generator

SECTIONS	L (mm)	W (mm)	H (mm)	Kg
Head Unit (no motor)	1505	930	285	85
Head Unit (with motor)	1525	1015	300	120
Base tension unit	1545	730	285	93
1.2m section	1350	620	285	43
2.4m section	2550	625	285	85
Available lengths	2.86, 4.06, 6.46, 7.66, 8.86, 10.06, 11.26, 12.46, 13.66, 14.86, 16.06, 17.26, 18.46, 19.66, 20.86, 22.06, 23.26, 24.46, 25.66, 26.86			
Other	Plain, 15mm chevron, 50mm cleated belt	Fully galvanised		

# Easikit™ 900

Hire ✓ Buy ✓

The modular Easikit™ 900 is designed to support high-volume loads and larger throughput which makes it perfect for recyclables and bulk materials handling. It can reach up to 40m on a single belt and with adjustable speeds of 0.2 – 1.2m/s, the Easikit™ 900 helps to significantly improve onsite productivity.

SPECIFICATIONS			
Industry	Building & Construction, Recycling, Rail, Agriculture, Composting & Biomass, Aggregates	Weight	Variable 80kg/m
Power supply	415V	Belt width	900mm
Type of material	Bulk materials, Recyclables	Belt speed	0.2m/s – 1.2 m/s
Loading method	By hand, Excavation, Wheelbarrow	Maximum throughput	125 tons p/h
Mobile or static	Static	Hopper size (if used)	940 x 1240mm
Length	Up to 40m	Max. incline angle	35°

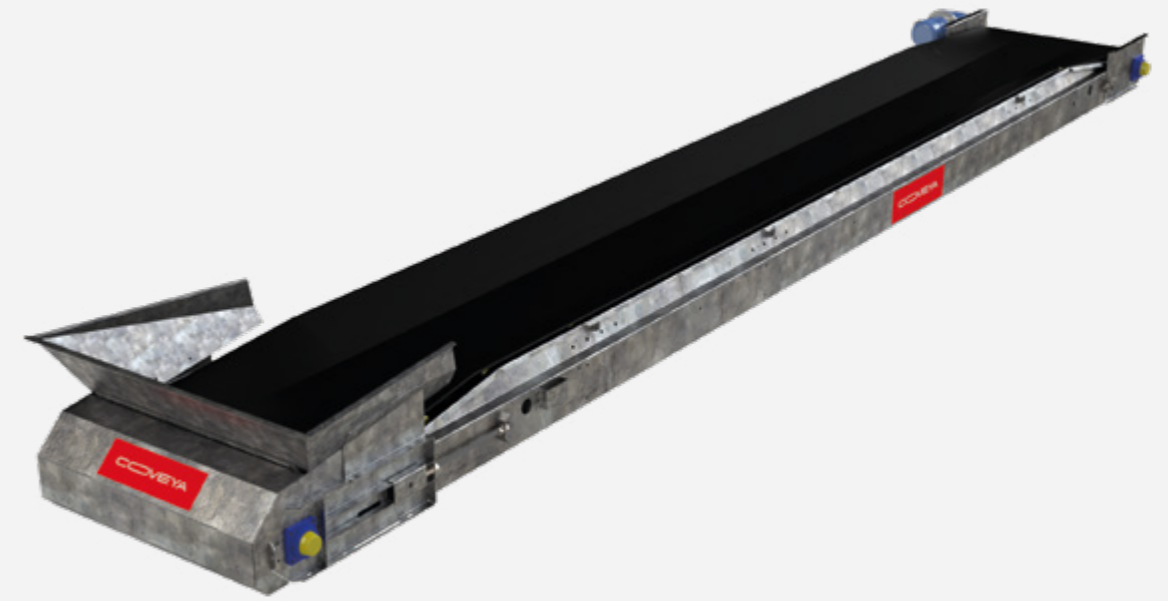

## CASE STUDY

### Helping to clear up at Glastonbury

With two shifts of ten volunteers on each of the 11 Coveya conveyor belts, 440 pickers worked 16 hours a day to sort through bags of rubbish, removing all plastic, paper and aluminium.

- 2,500 tons of rubbish to sift, sort and recycle
- 440 pickers working 16 hours a day
- 11 linked Easikit™ 900 conveyors
- 110m network of conveyors

SECTIONS	L (mm)	W (mm)	H (mm)	Kg
Head Unit (no motor)	1500	1225	310	103
Head Unit (with motor)	1500	1315	310	138
Base tension unit	1500	1020	285	111
1.2m section	1350	925	285	52
2.4m section	2550	925	285	96
Available lengths	2.86, 4.06, 6.46, 7.66, 8.86, 10.06, 11.26, 12.46, 13.66, 14.86, 16.06, 17.26, 18.46, 19.66, 20.86, 22.06, 23.26, 24.46, 25.66, 26.86			
Other	Plain, 15mm chevron, 50mm cleated belt		Fully galvanised	

# Easikit™ 1200

Buy ✓

The Easikit™ 1200 has an extra wide 1200mm belt which optimises throughput safely. It's extremely robust and is ideal for fast, efficient bulk materials handling, making it popular for large volume industrial applications, shifting up to 200 tons per hour.

SPECIFICATIONS			
Industry	Recycling, Agriculture, Composting & Biomass, Aggregates	Weight	Variable 80kg/m
Power supply	415V	Belt width	1200mm
Type of material	Bulk materials, Recyclables	Belt speed	0.2m/s – 1.2 m/s
Loading method	By hand, Excavator, Small machine, Wheelbarrow	Maximum throughput	200 tons p/h
Mobile or static	Static	Hopper size (if used)	940 x 1540mm
Length	Up to 40m	Max. incline angle	35°

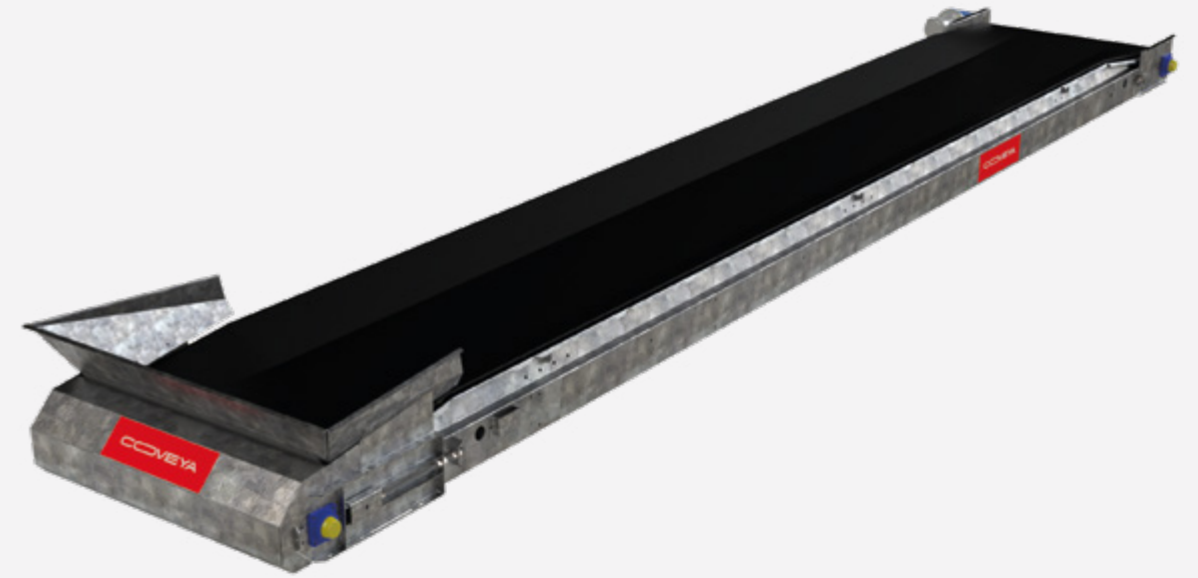

## CASE STUDY

### Reducing on-site costs

Gilpin Demolition needed a quick and safe method for processing the material to keep their project timescales on track and their costs low. Coveya's conveyor solution enabled Gilpin to reach rates of 60 tons per hour, vastly speeding up project time.

- 12,000 tons of material needing to be processed
- 1 bulk feeder hopper and 2 conveyors: Easikit™ 1200 and Easikit™ Mobile
- 60 tons of material processed per hour

SECTIONS	L (mm)	W (mm)	H (mm)	Kg
Head Unit (no motor)	1500	1525	310	122
Head Unit (with motor)	1500	1615	310	157
Base tension unit	1500	1320	255	120
1.2m section	1245	1225	285	54
2.4m section	2445	1225	285	100
Available lengths	2.86, 4.06, 6.46, 7.66, 8.86, 10.06, 11.26, 12.46, 13.66, 14.86, 16.06, 17.26, 18.46, 19.66, 20.86, 22.06, 23.26, 24.46, 25.66, 26.86			
Other	Plain, 15mm chevron, 50mm cleated belt		Fully galvanised	

## WHAT OUR CUSTOMERS SAY

"Using the conveyor system from Coveya is very effective, enabling us to produce rates of around 60 tons per hour, which vastly speeds up our project time and reduces our programme costs. We've had a good relationship with Coveya; their customer service is second to none".

Paul Nicholls MCM, Commercial Director  
Gilpin Demolition Group





# Easikit™ 1500

Buy ✓

The extra wide, modular Easikit™ 1500 is designed for high-volume, low density material handling. It's simple to assemble, making it perfect for a range of applications and environments, enabling material to naturally spread across the conveyor for easy sorting and picking.

SPECIFICATIONS			
Industry	Recycling, Agriculture, Composting & Biomass, Aggregates	Weight	Variable 90kg/m
Power supply	415V	Belt width	1500mm
Type of material	Bulk materials, Recyclables	Belt speed	0.2 m/s – 1.2m/s
Loading method	By hand, Excavator, Small machine, Wheelbarrow	Maximum throughput	300 tons p/h
Mobile or static	Static	Hopper size (if used)	940 x 1935mm
Length	Up to 30m	Max. incline angle	35°

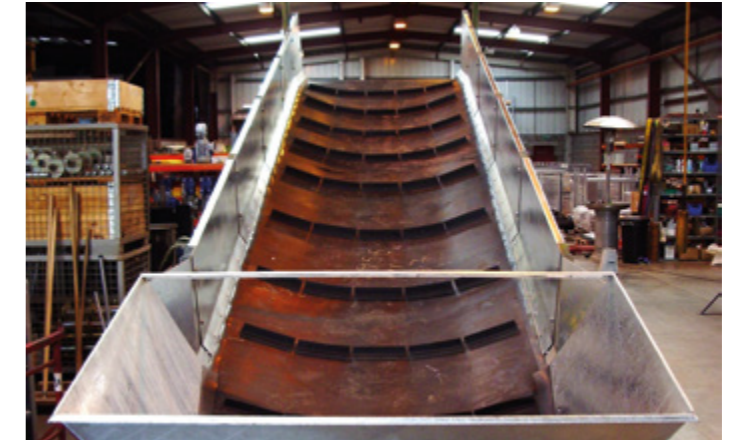
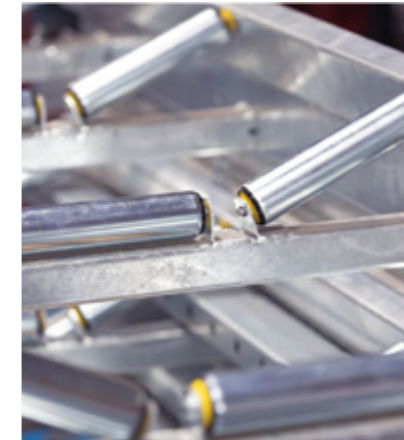
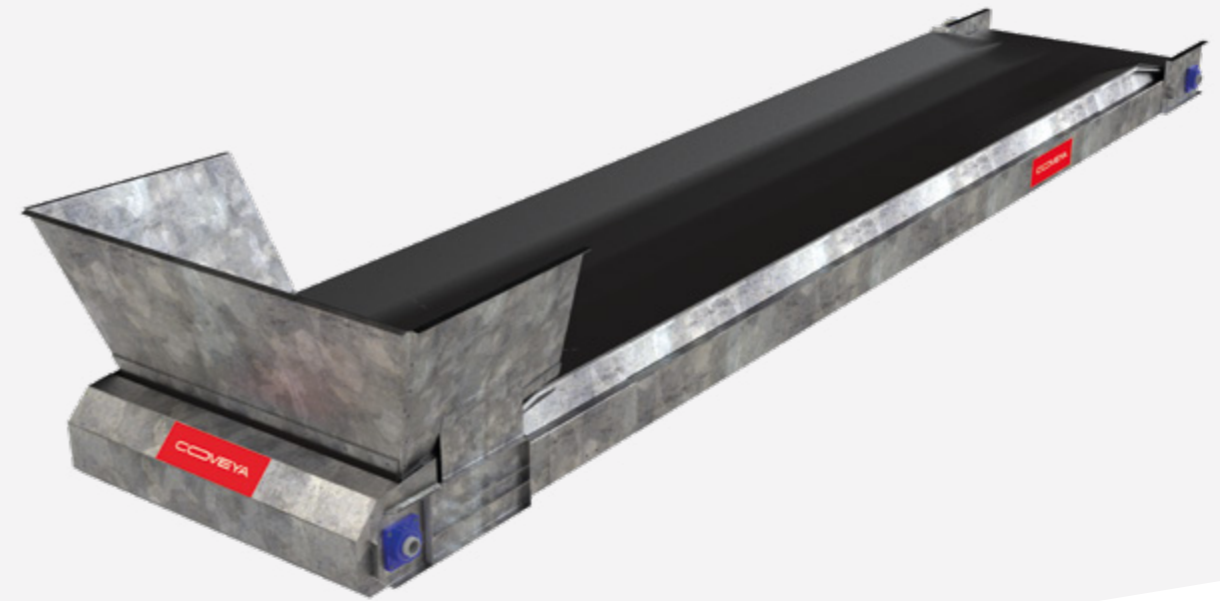

SECTIONS	L (mm)	W (mm)	H (mm)	Kg
Head Unit (no motor)	1500	1870	380	228
Head Unit (with motor)	1500	1960	380	279
Base tension unit	1500	1640	380	240
1.2m section	1350	1525	380	91
2.4m section	2550	1525	380	161
Available lengths	2.86, 4.06, 6.46, 7.66, 8.86, 10.06, 11.26, 12.46, 13.66, 14.86, 16.06, 17.26, 18.46, 19.66, 20.86, 22.06, 23.26, 24.46, 25.66, 26.86			
Other	Plain, 15mm chevron, 50mm cleated belt		Fully galvanised	

# The Easiveyor™

Hire ✓ Buy ✓

The Easiveyor™ is a unique, road-towable 5 metre Easikit™ 450 conveyor mounted on a trailer chassis, which is perfect for steel fibre handling. It comes complete with a 1.5kW 110v wired connection - simply 'plug-and-play' right off the truck and with an empty weight of well under 750kgs, the Easiveyor™ can be towed by most vehicles without any special licence.

SPECIFICATIONS			
Industry	Agriculture, Ready Mix Concrete Additive, Aggregates	Weight	685kg
Power supply	110V	Belt width	450mm
Type of material	Steel fibres	Belt speed	0.6m/s
Loading method	By hand, From boxes	Maximum throughput	300 tons p/h
Mobile or static	Mobile	Hopper size (if used)	630 x 800mm
Length	5m	Max. incline angle	45°



# Easikit™ Mobile

Hire ✓ Buy ✓

The Easikit™ Mobile 600, 900 & 1200 is the ideal solution for variable discharge heights. It's durable, weatherproof, easy to move around onsite and has a hydraulic ram to achieve inclines of up to 35 degrees.

SPECIFICATIONS			
Industry	Recycling, Rail, Agriculture, Composting & Biomass, Aggregates, Sewage & Sludge	Weight	Variable 100kg/m
Power supply	110V or 415V	Belt width	600mm, 900mm, 1200mm
Type of material	Aggregate, Recyclables, Sludge, Soil	Belt speed	0.2 m/s – 1.2 m/s
Loading method	By hand, Excavator, Small machine, Wheelbarrow	Maximum throughput	100 tons p/h
Mobile or static	Mobile	Hopper size (if used)	Variable
Length	Up to 14.86m	Max. incline angle	35°



Easikit™ 600 Mobile



Easikit™ 900 Mobile



Easikit™ 1200 Mobile

# Easikit™ Radial

Hire ✓ Buy ✓

Built to order, the Easikit™ 600, 900 & 1200 Radial is ideal for projects where a combination of radial slewing movements and variable discharge positions are needed. With its fixed feed point and powered radial wheels, this model rotates through a full 360-degree arc and is supplied with a hydraulic ram and hand pump for easy height adjustment.

SPECIFICATIONS			
Industry	Recycling, Agriculture, Composting & Biomass, Aggregates, Sewage & Sludge	Weight	1000kg
Power supply	415V	Belt width	600mm, 900mm, 1200mm
Type of material	Recyclables, Sludge	Belt speed	0.2 m/s – 1.2 m/s
Loading method	By hand, Excavator, Small machine, Wheelbarrow	Maximum throughput	25 tons p/h
Mobile or static	Mobile	Hopper size (if used)	785 x 850mm
Length	Up to 12.46m	Max. incline angle	30°





**WE OFFER FREE EXPERT  
ADVICE AND SUPPORT**

making sure you find the right  
conveyor for your specific needs



# Easikit™ Flatbed

Buy ✓

The Flatbed conveyor is available in four widths – 600, 900, 1200 and 1500mm wide – and is predominantly used for dry materials handling in the recycling industry. This very robust conveyor is great for baler infeed or picking line conveyors and is easily customisable to suit individual site requirements.

SPECIFICATIONS			
Industry	Recycling	Belt width	600mm, 900mm, 1200mm, 1500mm
Power supply	415v	Belt speed	0.2m/s-1.2m/s
Type of material	Cardboard/paper, Dry waste, Mixed recyclables	Maximum throughput	20 tons p/h – 100 tons p/h
Loading method	By hand, Machine loading, Conveyor feed	Max. incline angle	35°
Mobile or static	Static & Mobile	Belt Spec	Plain smooth, Grip top, 50mm Flighted Belt
Length	3.1m – 35.6m		

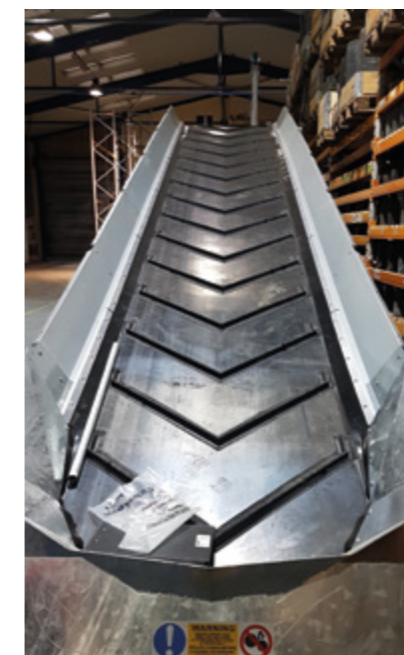
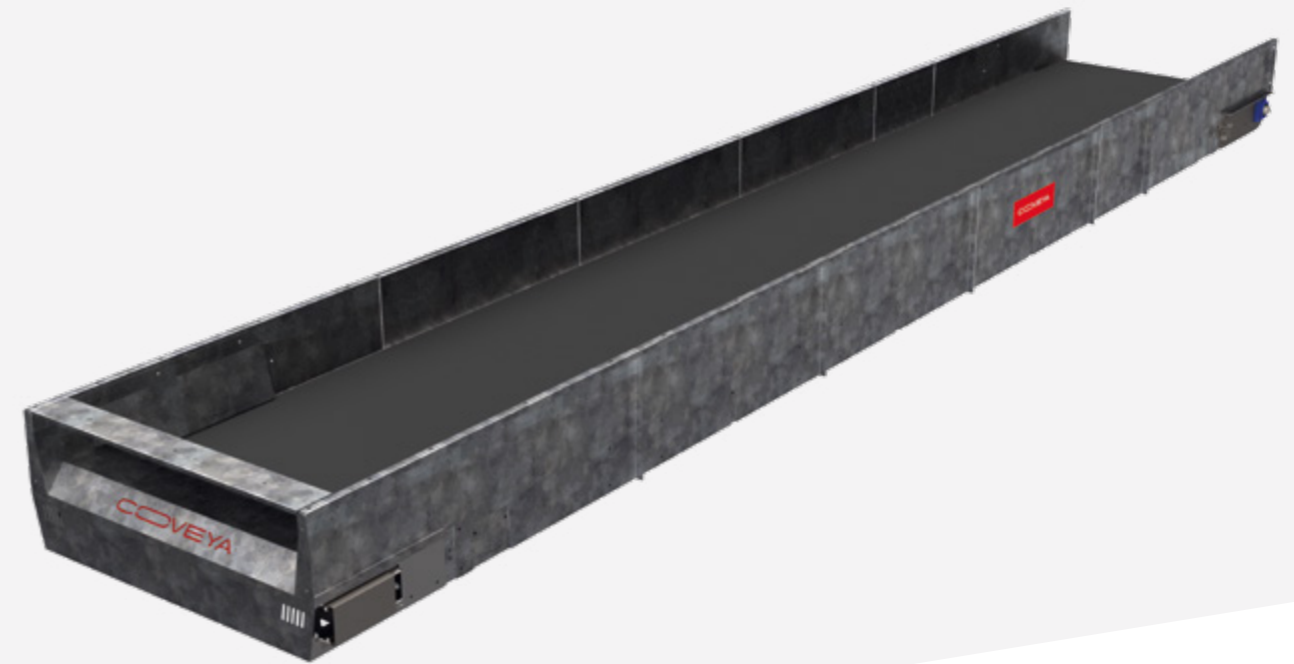

WITH 30 YEARS' EXPERIENCE OF MANUFACTURING, SUPPLYING, MAINTAINING AND SERVICING OUR EXTENSIVE RANGE OF CONVEYOR SYSTEMS, COVEYA LEAD THE WAY IN SUPPORTING AN ARRAY OF INDUSTRIES TO EFFICIENTLY MOVE A VARIETY OF MATERIALS

# The Easibelt™

Buy ✓

The Easibelt™ is reliable, compact and high-quality, making it perfect for factories and warehouses without the need to design a bespoke conveyor. The Easibelt™ is built using zinc-plated steel and is easy to adapt and reconfigure on your site. The system is engineered for longevity and ease, as it is quick to install and robust in its construction.

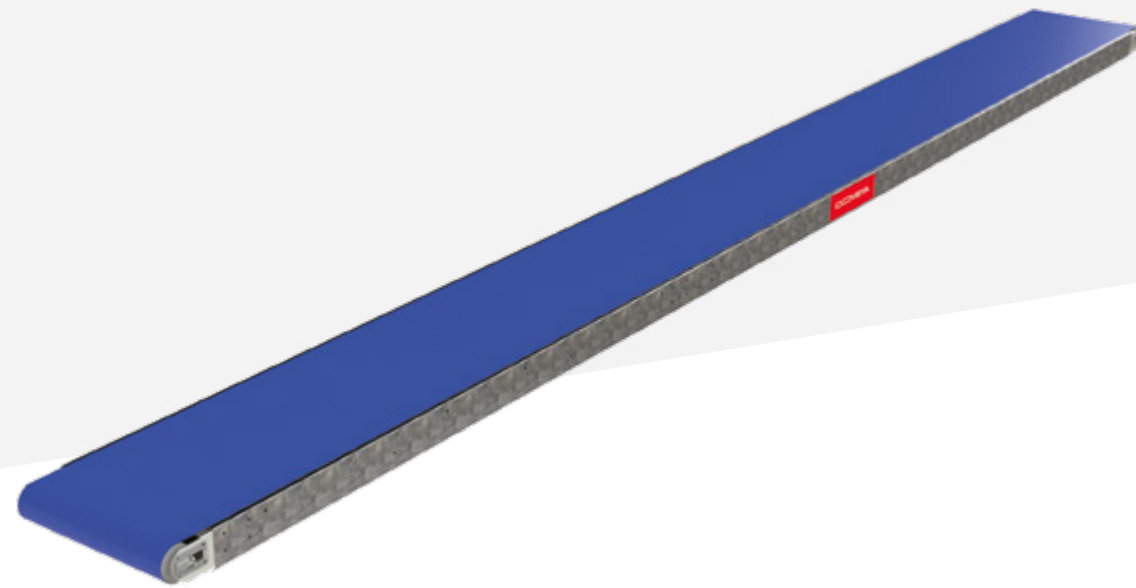

SPECIFICATIONS	
Industry	Recycling, Agriculture, Factories & Warehouses
Power supply	230V
Type of material	Unit handling
Loading method	By hand
Mobile or static	Static
Length	Over 20 standard lengths from 0.9m – 12.9m
Belt width	300mm, 600mm, 900mm
Belt speed	0.2 - 0.9m/s
Max. incline angle	25°



# The Easitrak™

Buy ✓

The Easitrak™ is an affordable roller conveyor system that is quick and easy to set up. With a variety of belt widths – 300mm, 600mm and 900mm – it's adaptable and comes complete with a pair of end plates that can be used as an end cover or a stop, depending on the way they are fitted. The Easitrak™ is constructed using 50mm diameter steel, bright zinc-plated rollers with steel bearings, and spring-loaded steel spindles for strength and durability.



SPECIFICATIONS	
Industry	Recycling, Agriculture, Factories & Warehouses
Type of material	Unit handling
Loading method	By hand, Roller pitch
Mobile or static	Static
Length	600mm, 1200mm, 2400mm
Belt width	300mm, 600mm or 900mm



# HC1000 Monstaveya™

Hire ✓

Precision-engineered for heavy-duty materials movement, the HC1000 Monstaveya™ is our most powerful conveyor solution. Designed to handle virtually all types of excavated material and demolition spoil safely and easily, this high-capacity unit provides exceptional throughput and durability, ideal for even the most challenging projects. It's capable of loading an 8-wheeler in just 6 minutes and this hardwearing conveyor helps to minimise downtime, reduce fuel, maintenance and labour costs from day one.

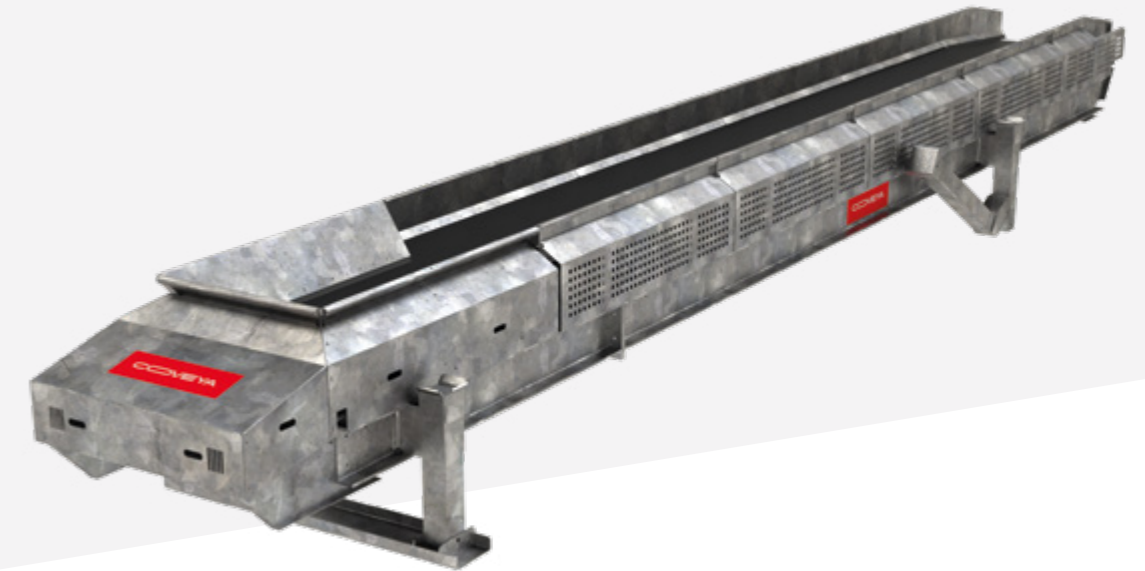

SPECIFICATIONS	
Industry	Recycling, Demolition & Remediation, Rail, Agriculture, Composting & Biomass
Power supply	415V
Type of material	Aggregate, Demolition rubble, Excavation spoil, Rubble, Small rubble, Soil
Loading method	Excavator, Large machine
Mobile or static	Static
Length	10m, 12m, 14m, 16m
Weight	3500kg
Belt width	1000mm
Belt speed	1.2m/s
Maximum throughput	500 tons p/h
Hopper size (if used)	1100 x 1800
Max. incline angle	30°



## CASE STUDY

### Minimising downtime for Crossrail

Crossrail contractor Colas needed to replace the ballast on a single-wide track at Gidea Park Station, but their excavator arms couldn't reach across the platform.

**We supplied an innovative solution that minimised track disruption, helping them to complete the work quickly and reliably.**

- Up to 500 tons of ballast per hour
- Entire project had to be completed over a bank-holiday weekend
- 3 x HC1000 Monstaveyas™, each 1m wide and 10-12m long including unique wheeled frames



# The GP750

Hire ✓

The GP750's high-performance system and robust design make it the first choice for demolition sites. Its wide belt and 5.5kW heavy-duty motor enable it to maintain a throughput of up to 300 tons per hour and it's designed to be low maintenance with a considerable lifespan.

SPECIFICATIONS			
Industry	Recycling, Demolition & Remediation, Rail, Agriculture, Composting & Biomass	Belt width	750mm
Power supply	415V	Belt speed	1m/s
Type of material	Aggregate, Demolition rubble, Excavation spoil, Rubble, Small rubble, Soil	Maximum throughput	300 tons p/h
Loading method	Bobcat, Excavator	Hopper size (if used)	1100 x 1100mm
Mobile or static	Static	Max. incline angle	30°
Length	Up to 50m		

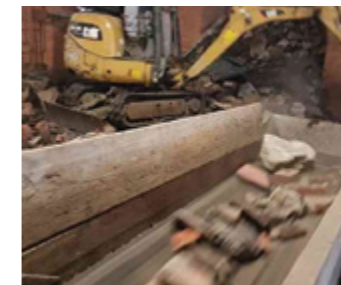
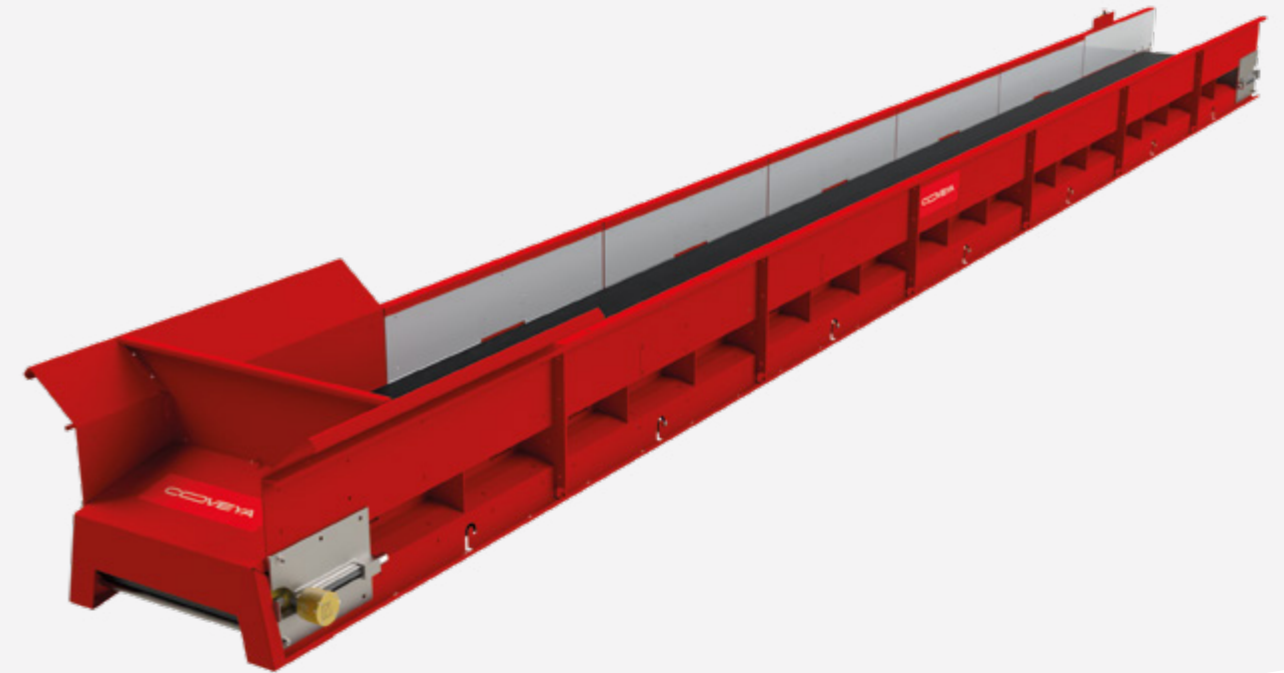

## CASE STUDY

### Listed Mill Demolition, Manchester

Northbank Demolition removed the basement, ground floor and a further three floors and roof from the former listed mill leaving behind the four façade walls. The mill also incorporated a lift shaft that passed through all the original floors.

The project took place in a number of stages starting with the stripping of all floors,

removing the roof and wood floor covering with ash fill. One level was removed at a time.

With such a complex project within a constrained site, the Coveya Easikit™ 600 and GP750 conveyor systems came into their own, enabling the removal of materials from the mill where there was a lack of lay down areas externally, with the demolition being carried out using small 1-ton demolition machines. After an initial free site visit by Coveya, the team provided a clear list of items needed to fit the conveyors and after placing the order, we were on site within two days, with all fitting work being carried out quickly and efficiently. Our conveyor experts also provided training, remaining on site to ensure everything was working and performing as it should.

Coveya were able to position the conveyors through the façade retention scaffold and position the end directly over the skip. By doing this the project was completed far quicker (saving two weeks per floor) and it helped to dramatically reduce the need for manual labour.

The conveyor system was perfect for this demolition project, especially as space was at a premium.

It offered cost and time saving and also supported stringent health and safety procedures. We were delighted to support this historic project and Coveya continue to work with Northbank Demolition on a number of Manchester-based projects.



# Bulk Feed Hopper FH510

Hire ✓ Buy ✓

Our Bulk Feeder Hopper is designed to provide a controlled flow of material onto our conveyors, allowing operators to load systems efficiently with a wheeled loader or excavator. It provides a buffer of material to ensure continuous loading with a speed-adjustable belt and it's perfect for aggregates and demolition projects.

SPECIFICATIONS			
Industry	Recycling, Demolition & Remediation, Agriculture, Aggregates	Bulk capacity	15m <sup>3</sup>
Power supply	415v Drive	Length	5m
Legs	Adjustable height	Width	2m
Discharge height	1m - 1.5m	Height	3.5m
Belt speed	Variable	Weight	5500kg
Discharge gate	Adjustable		

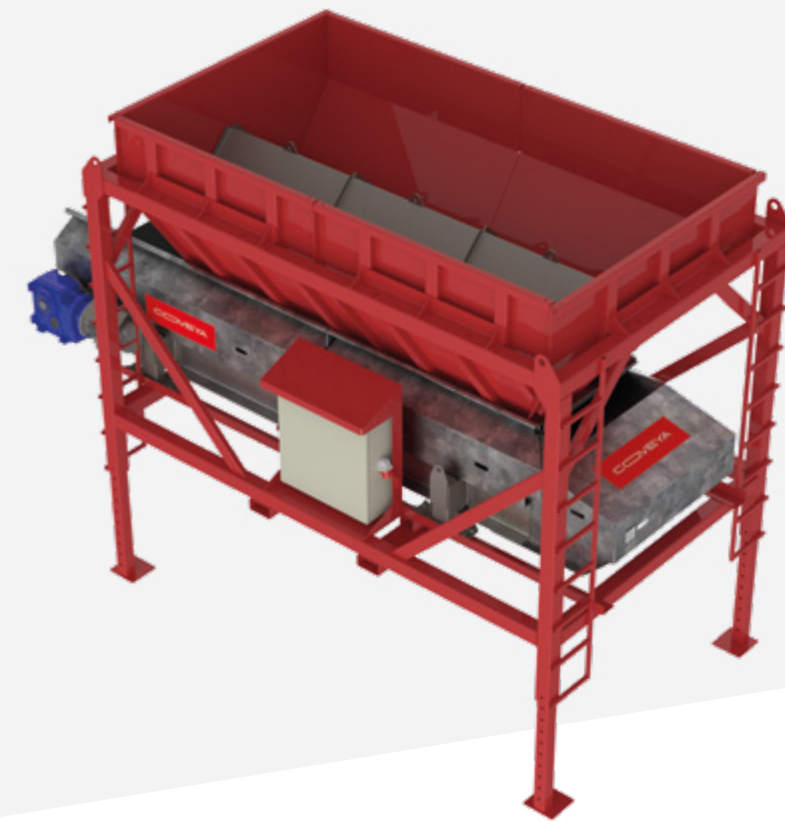

**WE OFFER FREE EXPERT ADVICE AND SUPPORT**

making sure you find the right conveyor for your specific needs

## Easikit™ Extras | Electrical Buy ✓



### Emergency Stop Grab Wires

Can be mounted on either side of the conveyor to provide a continuous emergency stop system for the full length of the conveyor. Supplied complete with eye bolts – a legal requirement for conveyors over 5m in length and accessible.

PRICE CODE	
Up to 10m	<b>630</b>



### Motor Starter

Direct-on-line starter in durable enclosure incorporating thermal overload for motor protection. Sealed to IP65. Supplied loose.

PRICE CODE	
1.5kW	<b>633</b>
3kW	<b>634</b>
4kW	<b>635</b>



### Variable Speed Controller

This environmentally friendly controller will reduce your running costs and its soft start will reduce wear, giving longer life to moving parts. Supplied loose. Provides a variable belt speed to suit your application. Totally enclosed and sealed to IP65.

PRICE CODE	
	<b>637</b>



### Motion Sensor

The motion sensor is supplied loose and should be wired to a control panel to indicate belt movement. This should be attached to the tail drum.

PRICE CODE	
	<b>638</b>

## Easikit™ Extras | Belt Scrapers Buy ✓

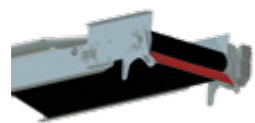

### Primary Belt Scraper

A cost-effective way to help prevent material carryback on the return belt when conveying viscous material. Suitable for plain belt and clipped or vulcanised joints, the primary scraper has a manually adjustable polyurethane blade and is mounted on the drive drum bearing for easy fitting.

	PRICE CODE	
	STANDARD	SNUB
Easikit™ 450	<b>440</b>	<b>N/A</b>
Easikit™ 600	<b>640</b>	<b>642</b>
Easikit™ 900	<b>940</b>	<b>942</b>
Easikit™ 1200	<b>1240</b>	<b>1242</b>
Easikit™ 1500	<b>1542</b>	<b>N/A</b>



### Secondary Belt Scraper

Assists the primary scraper in helping to prevent material carryback on the return belt. Suitable for plain belt and clipped or vulcanised joints, the secondary scraper is mounted behind the primary scraper and shares the same bracket as the primary scraper mounted onto the drive drum bearing. The scraper has a manually adjustable polyurethane blade which provides a good back up when fitted with the primary scraper, especially when handling sticky material i.e. sewage cake.

	PRICE CODE	
	STANDARD	SNUB
Easikit™ 450	<b>441</b>	<b>N/A</b>
Easikit™ 600	<b>641</b>	<b>643</b>
Easikit™ 900	<b>941</b>	<b>943</b>
Easikit™ 1200	<b>1241</b>	<b>1243</b>
Easikit™ 1500	<b>1543</b>	<b>N/A</b>

## Easikit™ Extras | Belt Scrapers Buy ✓



### Self-Adjusting Belt Scraper

This is the perfect solution for keeping your belt clean when access to the drive drum is difficult and you want peace of mind that your belt will be kept clean without the need to manually adjust the scraper blade. Ideal for conveyors in locations where low maintenance is required.

	PRICE CODE
Easikit™ 450	<b>450SA</b>
Easikit™ 600	<b>600SA</b>
Easikit™ 900	<b>900SA</b>
Easikit™ 1200	<b>1200SA</b>
Easikit™ 1500	<b>1500SA</b>

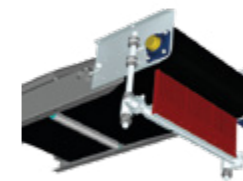

### Finger Belt Scraper

These are the ultimate option for keeping your belt clean. The heavy duty finger scrapers are suitable for cleaning chevron belt or plain belt if required. The scrapers come supplied complete with a heavy duty mounting frame. There are 2 types of scraper available:

#### A. FLAT BELT SCRAPER

5 finger blade with carbide inserts for use on all materials.

#### B. CHEVRON BELT SCRAPER

7 finger blade with stainless steel inserts. For chevron belts transporting glass, clay and other hard-to-remove materials.

	PRICE CODE	
	A	B
Easikit™ 450	<b>444A</b>	<b>444B</b>
Easikit™ 600	<b>644A</b>	<b>644B</b>
Easikit™ 900	<b>944A</b>	<b>944B</b>
Easikit™ 1200	<b>1244A</b>	<b>1244B</b>
Easikit™ 1500	<b>1544A</b>	<b>1544B</b>

## Easikit™ Extras | Covers Buy ✓

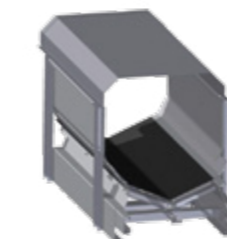

### Side Guide Top Covers

These Top Covers are designed to fit on top of our standard Side Guides. Provides the solution when both a continuous rubber skirt on the belt and an easily removable cover for maintenance is required. Also makes an ideal cover when larger bulky items are being moved that will not fit under our standard Top Covers.

	PRICE CODE
Easikit™ 450	<b>450SG</b>
Easikit™ 600	<b>650SG</b>
Easikit™ 900	<b>950SG</b>
Easikit™ 1200	<b>1250SG</b>
Easikit™ 1500	<b>1550SG</b>

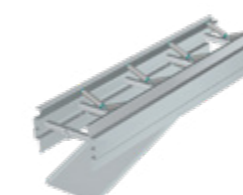

### Bottom Covers

Provided to enclose the running length of the conveyor with mesh panels, supplied in 1m (EK450) or 1.2m long sections and secured with nut and bolt fixings, they are supplied as an extra when needed for health and safety. They are a legal requirement when using cleated or chevron belt.

	PRICE CODE
Easikit™ 450	<b>451</b>
Easikit™ 600	<b>651</b>
Easikit™ 900	<b>951</b>
Easikit™ 1200	<b>1251</b>
Easikit™ 1500	<b>1551</b>

## Easikit™ Extras

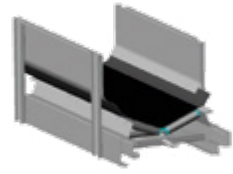

### Side Guides

Side Guides are used to control spillage of loose bulky material. Standard heights of 100mm and 300mm are available with continuous rubber side-skirts.

	PRICE CODE	
	100mm	300mm
Easikit™ 450	445	446
Easikit™ 600	645	646

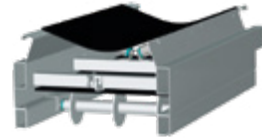

### Disc Return Rollers

Fitted with metal discs to help prevent material build-up on the roller itself. Recommended for use with sticky or difficult materials. Only suitable for use with plain or cleated belt.

	PRICE CODE
Easikit™ 600	655
Easikit™ 900	955
Easikit™ 1200	1255
Easikit™ 1500	1555

**Note:** Disc return rollers supplied as Easikit™ 1500



### Auto Grease Units

This is a self contained unit designed to automatically lubricate the bearing over a period of one to twelve months. Once fitted and activated, it will work without attention until its allotted lifespan is over.

PRICE CODE	639
------------	-----

## Support Stands & Stringers

### Adjustable Support Stands

Our modular support system for EASIKIT™ Conveyors is a cost-effective, combined design. The stands utilise a modular design with cross-bracing for heights of up to 20ft or higher, depending on site conditions.

STAND	HEIGHT TO UNDERSIDE	EK450	EK600	EK900	EK1200
1	13.5"	251	261	271	241
2	27.5 – 47.25"	252	262	272	242
3	57 – 97.5"	253	263	273	243
4	104.25 – 145"	254	264	274	244
5	151.5 – 192"	255	265	275	245
6	199 – 239.25"	256	266	276	246

\*Note: Pricing and availability for EK1500 support stands available on request.

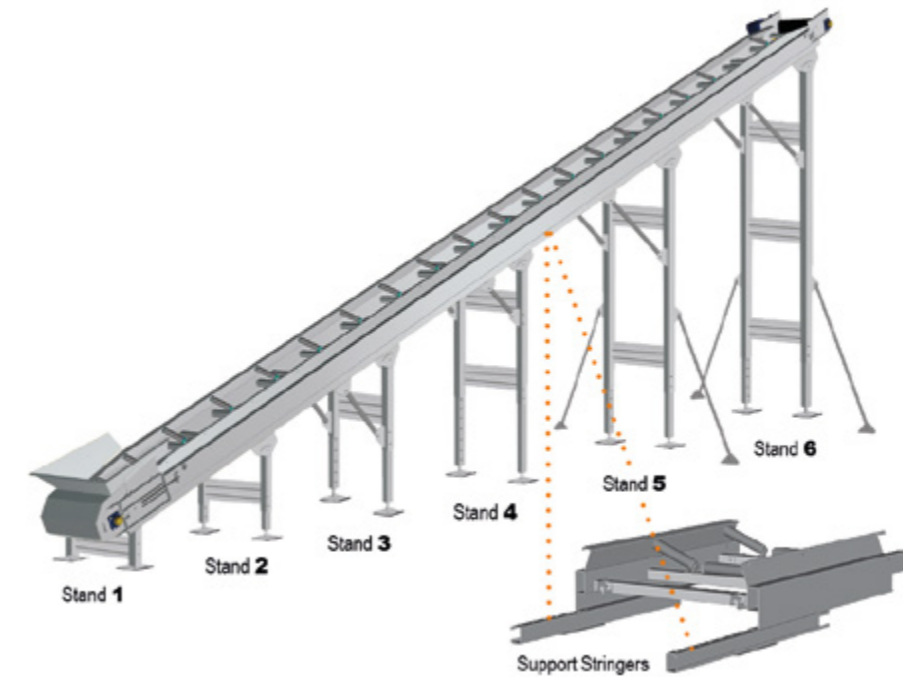

### Support Stringers

Fitted to the underside of the conveyor frame in modular 4' (1.2m) and 8' (2.4m) lengths. Provides adequate support for spans of up to 20ft centres (depending on loading). Constructed from galvanized 'C' section, thus increasing conveyor frame height by 3" (75mm). This can also be used as a cable tray.

CONVEYOR LENGTH	9'	13'	17'	21'	25'	29'	33'
PART NO.	280	281	282	283	284	285	286
CONVEYOR LENGTH	37'	41'	45'	49'	53'	57'	61'
PART NO.	287	288	289	290	291	292	293
CONVEYOR LENGTH	65'	69'	73'	77'	81'	85'	
PART NO.	294	295	296	297	298	299	



# About Coveya

**Coveya is a market-leading manufacturer and supplier of a range of commercial and industrial conveyor systems, for purchase or hire, supporting customers globally.**

With over 30 years' experience, our ongoing success stems from the quality of our products, including bespoke and modular conveyors, our commitment to exemplary customer service and our investment in the design and development of conveyors that support current and future customer needs.

We strive to deliver a complete materials handling solution; from free site visits and advice, to implementation, servicing and repair, and with a high percentage of repeat customers, the Coveya team always focus on adding value and delivering more.

Speak to a member of the Coveya team

**T. 0800 915 9195 E. [sales@coveya.co.uk](mailto:sales@coveya.co.uk)**



### Unconditional Guarantee

If our temporary conveyor system fails to provide tangible efficiencies on your project, we will remove it and you will not be charged



**Free** on-site survey



You can either **rent or buy** a range of conveyors from us

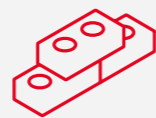

Modular conveyors that **keep your site moving**



If you need a **bespoke conveyor**, we can help



A real commitment to **adding value and delivering more**



Our customer service is **second to none**

"Pleased to say it did the job perfectly and we would not have any hesitation in recommending it to other contractors that have similar tasks to complete."

Groundworks Manager,  
Glossbrook Builders

"The guys changed a belt and couldn't believe how quick it was. They're chuffed to bits with how easy the Invader 45™ is to work on."

Service Manager, Rental Company

"A big thanks to everyone at Coveya for the speedy technical responses, excellent delivery time and good value conveyor system."

GM, Capital Compactors & Balers

"Without the help of the Coveya system we wouldn't have been able to get the reservoir roof reinstated with 750 tons of gravel. It's been a Godsend and I'd like to use the system again in the future if need be."

Project Manager,  
Future Industrial Services

**INDUSTRY SECTORS**

# How Coveya can help you

**Aggregates**

Our Easikit Mobile is based on the modular Easikit™ 600 and comes in 600, 900 or 1200 with a mobile undercarriage. The Easikit™ Radial is built to order and is specifically designed for automatic radial slewing. Together with our Bulk Feed Hopper, we supply the perfect conveyor solutions for the aggregate industry, enabling the removal and movement of gravel, sand, recycled concrete, slag, topsoil and ballast across construction and rail sites throughout the UK and further afield.

**Agriculture**

We can supply a comprehensive range of conveyors to the agriculture industry, all of which are designed to efficiently enable the processing of mill, seed, grain and other farm products, as well as the general movement of materials including animal feed.

**Basement Excavation**

Coveya prides itself on manufacturing flexible and robust conveyors that are suitable for all types of excavation projects. The Invader 45™ and our range of Easikit™ conveyors are specifically designed for the removal of muck and materials sometimes within complex and constrained sites. Our conveyors have supported a range of projects including a basement excavation at Claridge's Hotel and Harley Street, London.

**Building & Construction**

Coveya supply a comprehensive range of conveyor systems that are specifically designed to support a vast range of building and construction projects throughout the UK. Our conveyors enable the movement of materials for everything from complex excavations to large scale sites, demolition and remediation. Our conveyors can be on site quickly and are designed to eliminate downtime, ensuring that any building project keeps on track. We also offer free onsite visits, making sure that our conveyors best suit your construction needs.

**Composting & Biomass**

Our Easikit™ series, together with our heavy-duty conveyor range, are perfect for biomass handling, woodchip, wood shavings, pellets, oversized materials, compostables and the movement of waste. They are robust, flexible and efficient, offering the exact conveyor solution you need.

**Demolition & Remediation**

We manufacture and supply conveyors that are perfect for both complex remediation and demolition sites to large scale rubble, clearance, asbestos and soil removal. Our Invader 45™, Easikit™ 450 and Easikit™ 600 conveyors enable the removal of materials from constrained sites and the HC1000 Monstaveya™ and GP750 are the largest of our conveyor solutions, supporting largescale demolition sites. Whatever your requirements, we will provide a conveyor that is fit for purpose.

**Factories & Warehouses**

Our conveyors are mobile, robust and flexible. We can quickly deploy the right conveyor on site without you having to go to the time and expense of designing and buying a bespoke solution. With various lengths in stock for hire or purchase, we can help you decide which conveyor is right for your factory and warehouse and get you moving as quickly as possible.

**Landscaping & Groundworks**

Coveya manufacture conveyors that are perfect for all types of landscaping and horticulture projects. Their modular design means that they are mobile, robust and flexible enabling you to move materials around and away from site easily and quickly. From moving sand around site, to creating a volleyball pitch at the 2012 Olympics and small and large landscaping, groundworks and horticulture projects, we have a range of conveyors that offer flexibility and quality.

**Rail Track, Ballast Works, Demolition & Tunnelling**

We have a series of conveyors that are perfect for national rail improvement, expansion, tunnelling & demolition projects and we have already supported a range of complex rail projects throughout the UK, offering a unique eco-friendly conveyor solution. Their modular design supports projects within constrained and larger sites, eliminating downtime, passenger and operational disruption and noise pollution.

**Recycling & Waste Management**

From festival recycling to major waste distribution and management outlets, our extensive range of modular conveyors are perfect for materials recovery, EFW plants, AD facilities, picking and baling plants. Each are robust and flexible, providing the perfect solution for recycling and waste management.

**Water Treatment & Reservoirs**

We supply a range of conveyors designed to meet the needs of reservoir, dam, tideway restoration and water treatment sites across the UK including the removal and relocation of aggregate, soil and sediment from areas with limited access or tunnels and the treatment of sewage, dewatered sludge, dried biosolids, cake and wastewater handling, alongside other treatment processes. We offer free onsite visits that help us to find out more about how the conveyor will be used, so that we can recommend the very best conveyor for your water treatment or reservoir project.

CASE STUDY

# Thames Tideway Project

## Water Treatment

### FLO JV are constructing part of the Thames Tideway super sewer tunnel project on the Albert Embankment close to Vauxhall Bridge.

The site is located on the foreshore and has tight space constraints making delivery of material to the tunnel shafts difficult. Coveya were called in to assess the feasibility of installing a temporary conveyor solution to move backfill material from the delivery area along the river path to the newly constructed cofferdam in the river approx. 80 metres away.

The river path has been closed to the public and is used by multiple teams working on or within the cofferdam – the traditional method of using wheeled plant to transport the backfill material would not only have been inefficient and costly, but brought safety challenges too.

Our proposal included a 3D drawing to assist with the project planning and then our fitting team installed the conveyors, which were a bespoke solution based on our Easikit™ 600 conveyor.

The conveyors were loaded by an excavator and then material was efficiently discharged 80m away into the cofferdam by the conveyors, before being levelled and compacted by another excavator.



## OUR INTERNATIONAL DISTRIBUTORS

Coveya work with a number of international distributors that supply a range of our conveyors supported by servicing, maintenance and quality customer service.

To find out more, contact a member of the sales team on 0800 915 9195 or visit our website.

Australia

**[www.ch-s.com.au](http://www.ch-s.com.au)**

Finland

**[www.vimelco.fi](http://www.vimelco.fi)**

Ireland

**[www.glendunplant.com](http://www.glendunplant.com)**

Norway

**[www.sptools.no/om-oss](http://www.sptools.no/om-oss)**

USA

**[www.interquip.net](http://www.interquip.net)**

New Zealand

**[www.nzconveyors.co.nz](http://www.nzconveyors.co.nz)**

**TALK TO THE COVEYA TEAM TO FIND OUT MORE**

Call 0800 915 9195 | [sales@coveya.co.uk](mailto:sales@coveya.co.uk)