



GYS

CAR BODY WELDING SYSTEMS 2023 B

www.gys.fr



INVEST IN THE FUTURE



French manufacturer  
since 1964



# Car Body Welding Systems

Catalogue Carrosserie

Catalogo Carrozzeria

Karosserie-Schweißtechnik Katalog

Catálogo de Soldadura para Carrocería

2  
0  
2  
3  
B



SPOT WELDING

DENT PULLER

MIG

PLASMA

INDUCTION

LIFT

RIVETING

BODYSHOP TOOLS

INVEST IN THE FUTURE

## A solid manufacturing group

900 people € 125 000 000

C1+ Credit Rating Banque de France  
55 000 m<sup>2</sup> 2 factories



INVEST IN THE FUTURE



French manufacturer since 1964

## A family company



Nicolas & Bruno Bouygues

## 3 catalogues

3 500+ references



Welding, Plasma cutting & Induction heating



Car Body Welding Systems



Chargers, Boosters & Starters

## A worldwide coverage

125 countries



**GYS FRANCE**  
Laval

**GYS GERMANY**  
Aachen

**GYS U.K.**  
Rugby

**GYS CHINA**  
Shanghai

**GYS ITALIA**  
Venezia

**GYS IBERICA**  
Madrid

www.gys.fr



visit with



## DENT PULLING

GYSLOT	6
GYSLOT PRO	7
GYSLOT ALU	8
GYSLOT COMBI	9
ACCESSORIES & CONSUMABLES	10
GYSLOT ARCPULL	12
COMBI ARCPULL	13
ACCESSORIES & CONSUMABLES	16
FAST EASY TOOLS	18
ACCESSORIES LEVELLING BARS	20
COMPLETE WORKSTATIONS	24

## PULLING SYSTEMS

AIRFIX DRAW ALIGNER	39
DRAW ALIGNER	40
FRAME STRAIGHTENING	42

## PAINTLESS DENT REPAIR

POWERDUCTION AUTO DENT REPAIR	46
GLUE PULLING KITS	48

## TRUCK TOOLS & MOBILE LIFTS

TROLLEY IW1 / MULTITOOL TRUCK	51
SPOT LIFT	52
ERGOLIFT / QUICKLIFT	54
AIR JACKS / MANUAL WHEEL LIFT	55

## SPOT WELDING

TECHNOLOGY	58
PORTASPOT / GYSLOT 32D-X / 100R-CX	61
GYSLOT BP-LX / BP-LC-S7	62
GYSLOT PTI-S7	63
GYSLOT BP GENIUS	66
GYSLOT PTI PREMIUM PRO	68
GYSLOT PTI GENIUS	70
G ARMS	72
ACCESSORIES & CONSUMABLES	73

## RIVETING

GYSPRESS 10T	77
GYSPRESS 10T PP	78
GYSPRESS PREMIUM 10T PP	79
WORKSTATION	81
ADAPTERS	83
DIES BOXES & RIVETS	84
ACCESSORIES	87

## MIG WELDING

GYS AUTO	90
MULTIPEARL AUTO	91
E GYS AUTO	92
AUTOPULSE	95
TORCHES & CONSUMABLES	98

## INDUCTION HEATING

GYSDUCTION	102
COMBIDUCTION	103
POWERDUCTION	104
ACCESSORIES & CONSUMABLES	108

## PLASMA

EASYCUT	112
CUTTER	113

## ACCESSORIES

WELDING HELMETS	117
FUME EXTRACTION	121
WINDSCREEN REPAIR	122
BUMPER REPAIR	124
HAND TOOLS	126
PNEUMATIC TOOLS	128
SANDING & DUST EXTRACTION	130
WORKING LIGHTS	132
WORKING SUPPORTS	134
SAFETY PROTECTION	137



# DENT PULLING

## STEEL / ACIER / STAHL

GYSPOT	6
--------	---

GYSPOT PRO	7
------------	---

## ALU

GYSPOT ALU	8
------------	---

## ALU + STEEL / ACIER / STAHL

GYSPOT COMBI	9
--------------	---

ACCESSORIES & CONSUMABLES	10
---------------------------	----

## DRAWN ARC

### ALU + STEEL / ACIER / STAHL

GYSPOT ARCPULL	12
----------------	----

COMBI ARCPULL	13
---------------	----

ACCESSORIES & CONSUMABLES	16
---------------------------	----

FAST DENT PULLING	18
-------------------	----

LEVELLING BARS	20
----------------	----

COMPLETE WORKSTATIONS	24
-----------------------	----



GYSPOT

# DENT PULLING STEEL ACIER - STAHL

- Stars - Étoiles - Ausbeulstern
- Rings - Anneaux - Zugösen
- Wavy wires - Fils ondulés - Wellendraht
- Impact shrinking - Rabattage d'impact - Glätten

## OPTIONS

Consommables - Consumables p.10



Chariots - Trolleys p.24



- Stars - Étoiles - Ausbeulstern
- Rings - Anneaux - Zugösen
- Wavy wires - Fils ondulés - Wellendraht
- Impact shrinking - Rabattage d'impact - Glätten

- Tempering - Rétreinte - Temperieren



NEW DESIGN



FIXED GUN

FIXED GUN

GYSPOT 2600

2600 A x1 AUTOMATIC

230V • 1~

052208

included



Automatic quick gun, 1.8 m, 70 mm<sup>2</sup> + Hammer (057272)

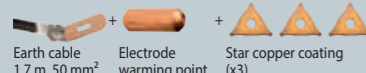

Earth cable 1.7 m, 50 mm<sup>2</sup> Electrode warming point Star copper coating (x3)

GYSPOT 2700

2600 A x1 MANUAL

230V • 1~

055353

included



Manual quick gun, 1.8 m, 70 mm<sup>2</sup> (058705) + Hammer (057272)

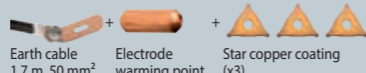

Earth cable 1.7 m, 50 mm<sup>2</sup> Electrode warming point Star copper coating (x3)

GYSPOT 34.02 & 34.04

3500 A x1 MANUAL

230V • 1~

GYSPOT 34.02 065741

400V • 2~

GYSPOT 34.04 067943

included



Manual quick gun, 2 m, 50 mm<sup>2</sup> + Hammer (057272)

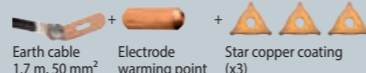

Earth cable 1.7 m, 50 mm<sup>2</sup> Electrode warming point Star copper coating (x3)

- Stars - Étoiles - Ausbeulstern
- Rings - Anneaux - Zugösen
- Wavy wires - Fils ondulés - Wellendraht
- Impact shrinking - Rabattage d'impact - Glätten
- Tempering - Rétreinte - Temperieren
- Rivets - Rivets - Nieten
- Rings - Rondelles - Unterlegscheiben
- Studs - Goujons - Gewindebolzen

SYNERGIC CONTROL

PATENTS REGISTERED NUMBERS EUROPEAN TRADEMARK & DESIGN



EXPERT SYNERGIC & MANUAL CONTROL

Welding current adjustment Welding time adjustment



GUN WITH CONNECTOR

GYSPOT 39.02 & 39.04

3800 A x1 AUTOMATIC

230V • 1~

GYSPOT 39.02 052215

400V • 2~

GYSPOT 39.04 052222

included



Automatic quick gun, 2 m, 70 mm<sup>2</sup> (057517) + Hammer (057272)



Earth cable 2 m, 70 mm<sup>2</sup> SPOTTER BOX STANDARD (053915) (Details p.10)

GYSPOT PRO 230 & PRO 400

3800 A x2 AUTOMATIC MANUAL

230V • 1~

GYSPOT PRO 230 052178

400V • 2~

GYSPOT PRO 400 052185

included



Automatic quick gun, 3 m, 50 mm<sup>2</sup> (057500) + Hammer (057272)

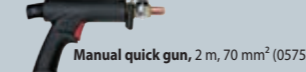

Manual quick gun, 2 m, 70 mm<sup>2</sup> (057524)



Earth cable 2 m, 70 mm<sup>2</sup> SPOTTER BOX PRO (050075) (Details p.10)

GYSPOT EXPERT 200, 230 & 400

3800-4500 A x2 AUTOMATIC MANUAL

230V • 1~

GYSPOT EXPERT 230 066885

200-240V • 1~

GYSPOT EXPERT 200 058842

4350 > 5100 A

400V • 2~

GYSPOT EXPERT 400 058859

4500 A

included

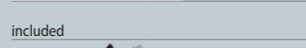

Automatic quick gun, 3 m, 70 mm<sup>2</sup> (059207) + Hammer (057272)

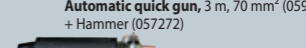

Manual quick gun, 2 m, 70 mm<sup>2</sup> (057524)

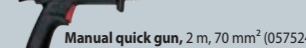

Earth cable Thick 3 mm 2 m, 70 mm<sup>2</sup> SPOTTER BOX PRO (050075) (Details p.10)

QUICK GUNS

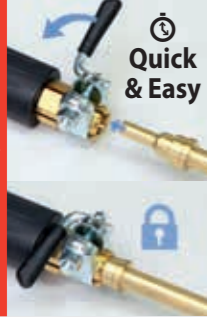

Quick & Easy

AUTOMATIC



WITH CONNECTOR 2 m, Ø 70 mm<sup>2</sup> included 39.02/04 057517



WITH CONNECTOR 3 m, Ø 50 mm<sup>2</sup> included PRO 230/400 057500

WITH CONNECTOR 3 m, Ø 70 mm<sup>2</sup> included EXPERT 200/230/400 059207

MANUAL



WITH CONNECTOR cable 2 m, Ø 70 mm<sup>2</sup> included PRO 230/400, EXPERT 200/230/400, COMBI 230EPRO 057524

No connector cable 1.8 m, Ø 70 mm<sup>2</sup> for 2700 058705

No connector cable 2 m, Ø 50 mm<sup>2</sup> for 34.02/34.04

Mandrels for gun - Mandrins pour pistolets - Pistole & Anschlußstücke, Zubehör



QUICK GUN 057531



D1 048959



Nut - Écrou 053199

Microswitch 053267

MADE IN GYS CHINA	G NORM 62135	50/60 Hz	I <sub>2</sub> max	U <sub>2</sub>	I <sub>AM</sub>	I <sub>RMS</sub>	kW	OK	OK	MANUAL	SYNERGIC	AUTOMATIC	MANUAL	SEPARATE CABLE GUN	LxWxH cm / kg
			A	V	A	A									40 x 25 x 31 / 18
															40 x 25 x 31 / 18
															42 x 36 x 31 / 23.9
															42 x 36 x 31 / 24
															49 x 38 x 29 / 27.5
															49 x 38 x 29 / 25.2
															49 x 38 x 29 / 29.6
															49 x 38 x 29 / 29.4
															49 x 38 x 29 / 34.6
															49 x 37 x 31 / 30.6
															49 x 38 x 29 / 32.9

MADE IN FRANCE

GYSPOT

STEEL DENT PULLING



GYSPOT ALU

# DENT PULLING ALU

FV FLEXIBLE VOLTAGE

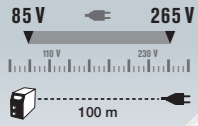

**FIXED GUN**

**SYNERGIC CONTROL** PATENTS REGISTERED NUMBERS EUROPEAN TRADEMARK & DESIGN

**Alu**

Goujons - Studs

**Steel / Acier / Stahl**

Stars - Étoiles  
 Rings - Anneaux  
 Wavy wires - Fils ondulés  
 Impact shrinking - Rabattage d'impact  
 Tempering - Rétreinte  
 Rivets - Rivets  
 Rings - Rondelles  
 Studs - Goujons

GYSPOT ALU PRO FV

100 · 230V · 1~

**7500 A** x1 AUTOMATIC

FV

021990

included

for Ø 4 mm



Automatic alu gun  
3 m, 25 mm<sup>2</sup>



ALU BOX STANDARD (050020)  
(Details p.11)

**ALU GUN**

**AUTOMATIC**

3 m, Ø 25 mm<sup>2</sup>

included SPOT ALU FV & COMBISLOT 230

054066



(x 3)  
065635

**66 mF** CAPACITOR DISCHARGE WELDING

Ø 4mm

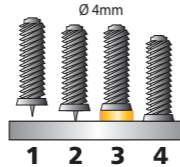

Joint rings for mandrel Ø 4/5/6 x 2  
060814

PATENTS REGISTERED NUMBERS 002446450-0001 EUROPEAN TRADEMARK & DESIGN

## OPTIONS

Consumables - Consommables p.11



ALU accessories - Accessoires ALU p.19



Trolleys - Chariots p.24



GYSPOT COMBI

# DENT PULLING ALU + STEEL ACIER - STAHL

**2 GUNS INCLUDED**



**GUN WITH CONNECTOR**

GYSPOT COMBI 230 E.PRO

230V · 1~

**3800 A** Acier / Steel / Stahl

**7500 A** Alu

x2  
AUTOMATIC  
MANUAL  
AUTOMATIC

021266

included



Manual quick gun, 2 m, 70 mm<sup>2</sup> (057524) + Hammer (057272)

Automatic alu gun, 3 m, 25 mm<sup>2</sup>



Earth cable 2 m, 70 mm<sup>2</sup>

SPOTTER BOX PRO (050075) (Details p.10)

ALU BOX STANDARD (050020) (Details p.11)

MADE IN FRANCE 62135	50/60 Hz			I <sub>2</sub> max A	U <sub>2</sub> V		I <sub>RMS</sub> A	kW			MANUAL	SYNERGIC			AUTOMATIC	MANUAL	SEPARATE CABLE GUN			LxWxH cm / kg
GYSPOT ALU PRO FV	110 · 230V	6 m	7500	50 · 200	5	—	0.65	OK	OK	—	—	—	—	—	x 1	—	—	3 m	Included Alu box	49 x 38 x 29 / 13.4
GYSPOT COMBI 230 E.PRO	230V	8 m	3800 (steel) 7500 (alu)	7,4 (steel) 50 · 200 (alu)	16	2800 (steel)	20	OK	OK	—	—	—	—	—	x 1	x 1	—	2/3 m	Included Spotter box + Alu box	54 x 76 x 34 / 47.5

GYSPOT

ALU + STEEL DENT PULLING





# DENT PULLING DRAWN ARC ALU + STEEL

ACIER - STAHL



MANUAL



- Rings - Anneaux - Zugösen
- Studs - Goujons - Gewindebolzen
- Stainless steel nails - Tiges inox - Edelstahlnägel



- Start-up - Amorce - Zündung
- Scouring (I & t) - Décapage - Abbeizen
- Arc (I & t) - Arc - Lichtbogen
- Hitching (I & t) - Accroche - Verklebung
- Height - Hauteur - Höhe

7 languages  
FR, EN, DE, SP, IT, NL & RU

## SYNERGIC DIGITAL GUNS

★★★★★  
**UNIQUE Linear Motor**

**DRAWN ARC PROCESS**  
Gas protection

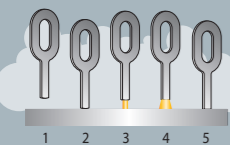

3 m, Ø 25 mm<sup>2</sup>  
included  
ARCPULL  
200 & 350,  
COMBI ARCPULL



Full control



Consumables for Gun



FV FLEXIBLE VOLTAGE

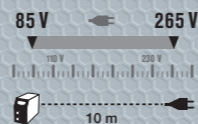

SR SECONDARY REGULATION

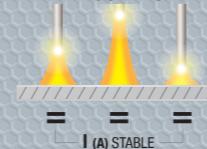

AD ANTI-DUST

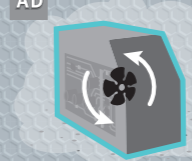

MANUAL & SYNERGIC CONTROL

NEW

2 GUNS INCLUDED



Ø max  
Alu : 6 mm  
Fe : 6 mm

GUN WITH CONNECTOR

### GYSPOT ARCPULL 200

100 · 230V · 1~  
**200 A** **T x1 MANUAL**  
FV SR AD  
057470  
included



### OPTIONS



### COMBI ARCPULL

230V · 1~  
**ARCPULL 200 A** + **EXPERT 3800 A**  
Alu + Acier / Steel / Stahl  
**T x1 MANUAL** + **T x1 MANUAL**

### OPTION : AUTOMATIC



MADE IN FRANCE 60974-1	50/60 Hz	I <sub>2</sub> A	SYNERGIC	MANUAL	IRMS (A)	T		U <sub>2</sub> V	AM A	kW	OK	OK	LxWxH cm / kg
						Acier/Steel	Alu						
<b>GYSPOT ARCPULL 200</b>	110 · 230V	6 m	10 · 100 (110 V) 10 · 200 (230 V)	■	■	—	Manual + Digital Gun Motion Control	20.4 · 24 V (110 V) 20.4 · 28 V (230 V)	16	2.4 (110 V) 5.6 (230 V)	OK	OK	49 x 37 x 30 / 14.5
<b>COMBI ARCPULL</b>	230V	8 m	Alu 10 · 200 Acier 3800	■	■	Steel 3800	Manual Automatic (not included)	Alu 20.4 · 28 V Steel 7.4 V	16	Alu 5.6 Steel 20	OK	OK	72 x 42 x 29 / 41.5



GYS POT ARCPULL

# DENT PULLING DRAWN ARC ALU + STEEL ACIER - STAHL

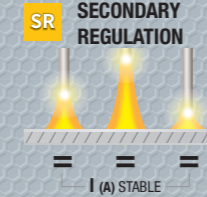
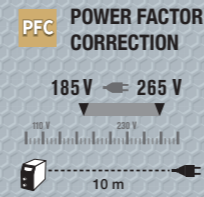

- Rings - Anneaux - Zugösen
- Start-up - Amorce - Zündung
- Hitching (I & t)
- Studs - Goujons - Gewindebolzen
- Scouring (I & t) - Décapage
- Accroche - Verklebung
- Stainless steel nails - Tiges inox
- Abbeizen
- Height - Hauteur
- Edelstahlnägel
- Arc (I & t) - Arc - Lichtbogen
- Hohe

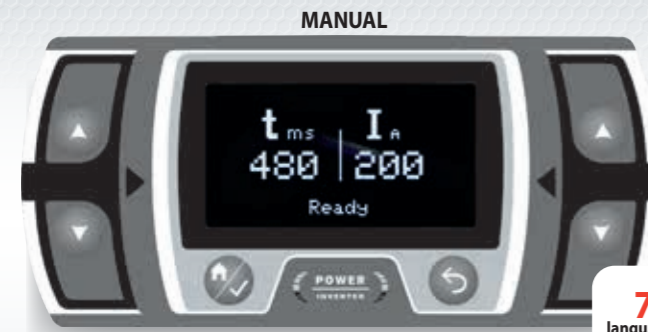

**7** languages  
FR, EN, DE, SP, IT, NL & RU



**NEW**



## SYNERGIC DIGITAL GUNS

★★★★★ **DRAWN ARC PROCESS**  
Gas protection

**UNIQUE Linear Motor**

**FULL CONTROL**

3 m, Ø 25 mm<sup>2</sup>  
included ARCPULL 200, 350 & COMBI ARCPULL

Consumables for Gun

- x2 059627
- x1 059610

### GYS POT ARCPULL 350

208 · 240V · 1~  
**350 A** x1 MANUAL

PFC SR AD

#### OPTIONS

Weld 810 for ARCPULL 350  
037489



062191

included



Manual synergic gun  
3 m, 25 mm<sup>2</sup>

#### PACKS ARCPULL 350

	Arcpull 350	Croco T400.70	Rivet box	Alu ring box 1.5 mm	Lifting rods
350 RIVET	■	■	■	—	—
350 PULLER	■	—	—	■	x1
350 PULLER + RIVET	■	■	■	■	x1

### GYS POT ARCPULL 700

380 · 480V · 3~  
**680 A** x1 MANUAL

SR IP 23

#### OPTIONS

Weld 910 for ARCPULL 700  
070967



### 068315

included

- Manual synergic gun 5 m, 50 mm<sup>2</sup>
- Arc Pull Rivet Box 700
- Lifting rod 180 mm (x1)
- Ground studs holder Ø 6 (x1) 075368, Ø 8 (x1) 075375, Ø 10 (x1) 075382
- Threaded holder Ø 5 (x1) 076174, Ø 6 (x1) 068391
- Double earth clamps 700 A, 3 m, 50 mm<sup>2</sup> 068605
- ALU RING BOX 1.5 mm (AlSpec + AlMg3 + AlMgSi) 059429
- Gas protection (x1) 068346

MADE IN FRANCE 60974-1	50/60 Hz	I <sub>2</sub> A	SYNERGIC	TECHNOLOGY		U <sub>2</sub> V	kVA	kW	IP	CE	LxWxH cm / kg
				Acier/Steel	Alu						
GYS POT ARCPULL 350	208 · 240V	6 m	10 · 350	Manual + Digital Gun Motion Control	■	20.4 · 34V	16	11.9	OK	OK	48 x 36 x 30 / 17.4
GYS POT ARCPULL 700	3x 400V 3x 480V	5 m	50 · 680	Manual + Digital Gun Motion Control	—	22 · 44V	20 A (D) 16 A (D)	47.8 kW 45.7 kW	OK	OK	60 x 43 x 46 / 27.8







# GYS POT ARC PULL 200, 350 & COMBI ACCESSORIES & CONSUMABLES

## ACIER / STEEL / STAHL

<b>STEEL STUDS BOX 200 &amp; 350</b> 059443	x1	x1				x1	x100		x1	x100	x100	x100								x1	x100

## ALU

<b>ALU STUDS BOX 200 &amp; 350</b> 059436	x1	x1	x1	x100	x1	x100	x1	x100	x1	x100	x100	x1	x100

	straight rings						twisted rings							
	Al-Special		AlMg3		AlMgSi		Al-Special		AlMg3 - x 50		AlMgSi - x 50			
box	n°1 1mm x100	n°4 1.5mm x100	n°8 2mm x100	n°2 1mm x100	n°5 1.5mm x100	n°3 1mm x100	n°6 1.5mm x100	n°1 1mm x50	n°4 1.5mm x50	n°2 1mm x50	n°5 1.5mm x50	n°3 1mm x50	n°6 1.5mm x50	
	059535	059559	065703	059498	059511	059450	059474	059542	059566	059504	059528	059467	059481	
box	<b>ALU RING BOX 1 mm</b> 059412		1mm x50		1mm x50		1mm x50		1mm x20		1mm x20		1mm x20	
box	<b>ALU RING BOX 1.5 mm</b> 059429		1.5mm x50		1.5mm x50		1.5mm x50		1.5mm x20		1.5mm x20		1.5mm x20	
sachet - bag	<b>ALU RING BOX 2 mm</b> 065703		2mm x100											

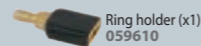

Earth clamp  
Croco T400.70  
043787



Double earth clamp  
25 mm², 3 m, 350 A  
070714



Joint rings for  
mandrel 04/5/6  
x2  
060814

<b>STUDS HOLDER BOX 350</b> 064591		x1	x1	x1	x1	x1	x1	x1	x1							x1
<b>ARCPULL DIFFICULT ACCESS BOX 350</b> 070813		x1	x1							x1	x1	x1	x1	x1	x1	x1

Difficult access:

<b>ARCPULL RIVET BOX 1 350 - 24kN</b> 064584		x1	x1	x1	x1	x1					
<b>ARCPULL RIVET BOX 2 350 - 50 kN</b> 073388		x1	x1				x1	x100	x1		

## GYS POT ARC PULL 700 - ACCESSORIES & CONSUMABLES

<b>ARCPULL RIVET BOX 700</b> 068452	x100	x1		x1	x1	x2	x1	x1	x1					



# FAST DENT PULLING

## STEEL / ACIER / STAHL

### EASY TOOL CONNECTION

for GYSPOT 39.02/04, PRO 230/400, EXPERT 230/400, COMBISPOT 230



051690

### MANUSPOT = 050679



Tools set and support for DENT 600, 800, 1000, 1600, Workstation & Dentstation



EASYGUN 051317



MANLINER 050471

3 m Ø 35 mm2

PATENTS REGISTERED NUMBERS 001652108-0003 EUROPEAN TRADEMARK & DESIGN

4 positions 4 Positionen

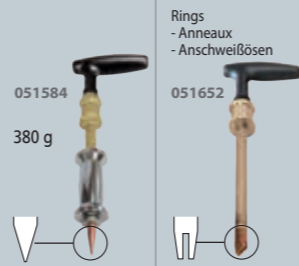
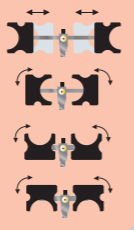

051584 380 g

Rings - Anneaux - Anschweißösen

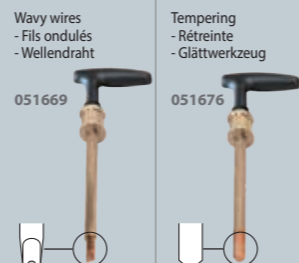

051669

Tempering - Rétreinte - Glättwerkzeug



Manual dent-pulling bar - Poignée de tirage manuel 057289

EASYGUN 051317

Box of 3 electrodes for accessories 050822

### FAST & EASY



RINGMATIC 052154

included (x 50)



Option Gun adapter - Adaptateur pistolet 052499

### MANLINER/GUN 056831

PATENTS REGISTERED NUMBERS 001652108-0003 EUROPEAN TRADEMARK & DESIGN



Gun adapter - Adaptateur pistolet included 052499

Pads - Patins (x2) 060807

### DENT AXE PULLER 080508

NEW

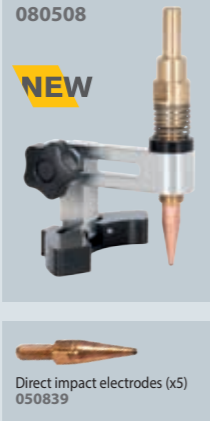

Direct impact electrodes (x5) 050839

### QUICK SPOT AIR GUN V2 057340



LIGHT 920 g

QUICK SPOT AIR GUN V2 + Mini-fraiseuse - Mini-Druckluftfräser 065567



Included Tungsten drill Ø 6 mm 054172

Gun adapter - Adaptateur pistolet 052826

### MANU PULLER 079502

079502



NEW

Included Alu 3 065178, Included 079830, Included Alu 4 065185

## ALU

### ARC PULLER PREMIUM 065161



Included Alu 3 065178

Included Alu 4 065185

Pads - Patins (x2) 069008

ULTRA RESISTANT No deformation

GRIP Full rotation

Multi positions

### ARC PULLER PREMIUM PRO 072572



Included Alu 3 065178, Included Alu 4 065185

Pads - Patins (x4) 074958

### ALU PULLER = 051003

4 positions

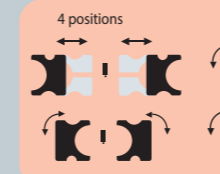

Included Alu 1 050938, Included Alu 2 050945

Patins - Pads (x2) 060807

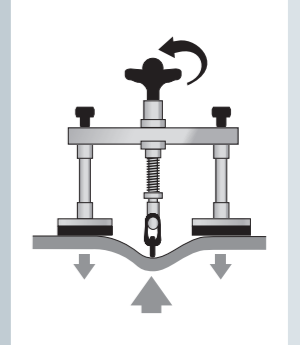

### STRAIGHT LINE LAMP - Lampe ligne droite - Dentline-laser 056770

056770



### FAST PULLING RINGS - Anneaux de tirage rapide 058743

058743

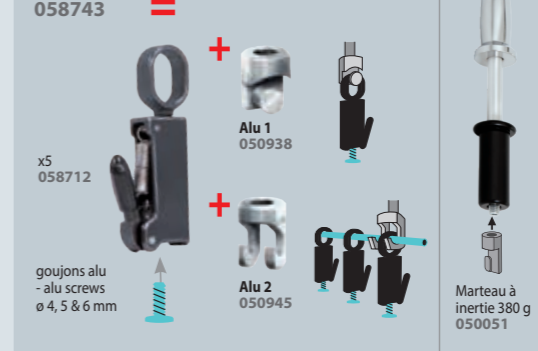

x5 058712

Alu 1 050938

Alu 2 050945

goujons alu - alu screws ø 4, 5 & 6 mm

### ALU HAMMERS - Marteaux alu 020986

020986



Marteau à inertie 380 g 050051

Heat gun - Décapeur thermique - Heißluftpistole

I: 100/300°C (450 W) II: 300/650°C (1500 W) Air flow: 450 l/min



066311

Gas hot air gun - Pistolet à air chaud autonome à gaz

Bouteille de gaz incluse, gas cylinder included



060777

Blow torch - Lampe à souder - Lötlampe

052741



052741

Novacet + (Butane/propane/proplyene) 380 ml/220 g

HIGH QUALITY



040441

Brushes - Brosses - Bürsten - Brosses - Cepillos

044258



044258

Thermal marking pencil - Crayon marqueur thermique

121°C / 250°F



052765

Infrared Thermometer - Thermomètre infrarouge

-50 / +380°C -58 / +716°F



052994

Freezer spray - Spray refroidisseur

-50°C 400 ml

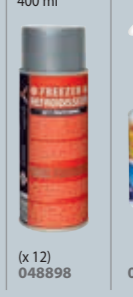

048898

Heat barrier spray - Spray barrière thermique

054325



054325



# PULLING BARS

## 3 PRODUCT LINES

### 1 STANDARD

### 2 PREMIUM



### 3 PREMIUM PRO



## STANDARD

**Levelling lever**  
- Levier de débousselage  
- Zughebel

**050686**  
↓ 1.6 kg  
⊗ 79 x 12 x 17 cm / 1.9 kg

PATENTS REGISTERED NUMBERS  
001652108-0002  
EUROPEAN TRADEMARK & DESIGN

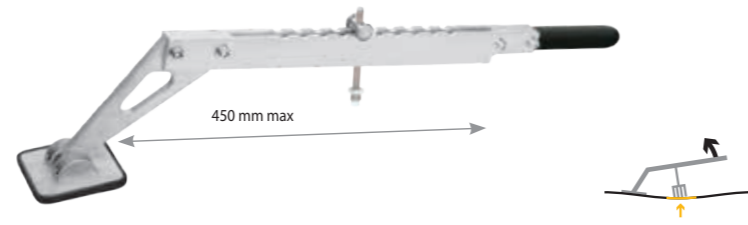

**Double action levelling bar**  
- Barre de débousselage double action  
- Zughebelbrücke

**053564**  
↓ 2.5 kg  
⊗ 77 x 12 x 13 cm / 3.2 kg

Licensed by  
BETAG.Innovation

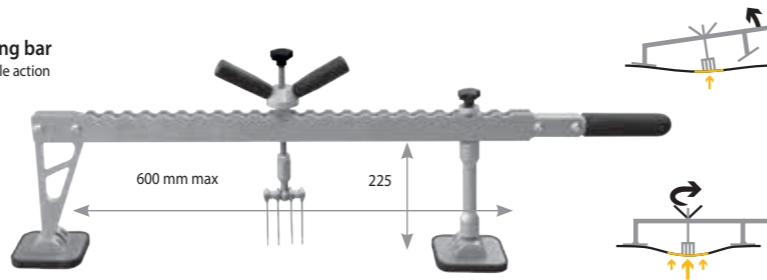

**Levelling bar**  
- Barre de débousselage  
- Zugbrücke

**050693**  
↓ 3.4 kg  
⊗ 87 x 17 x 19 cm / 4 kg

Licensed by  
BETAG.Innovation

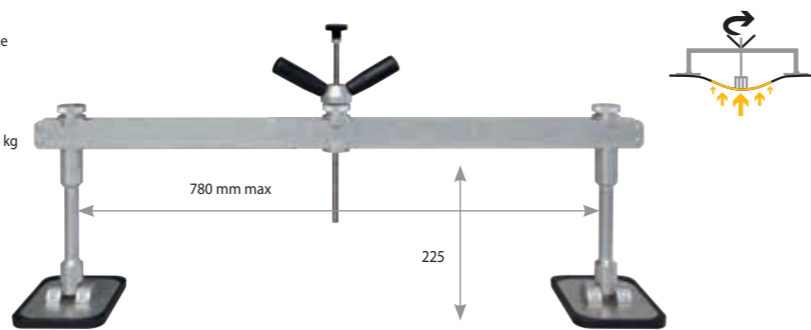

**Reinforced scissoring bar**  
- Barre de tirage renforcée  
- Scherenzugbrücke

**050716**  
↓ 5.1 kg  
⊗ 87 x 17 x 18 cm / 5.9 kg

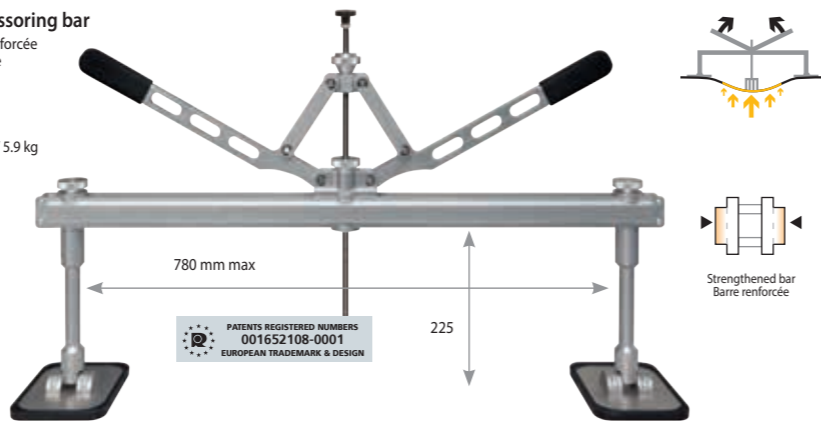

## SLIDE & LOCK

Removable system : pads and pulling systems  
Système amovible : patins et chariots de tirage

### FEET



### PULLING SYSTEM

only for 059313



## LIGHTWEIGHT

Léger



### GRIP 360

360° pads with grip  
Patins à frein orientables à 360°



### X-CROSS

Possibility of crossing the bars  
Possibilité de croiser les barres

## PREMIUM

**Premium levelling lever**  
- Levier de débousselage Premium  
- Premium Zughebel

**059290**  
↓ 1.6 kg  
⊗ 100 x 16 x 17 cm / 2.2 kg

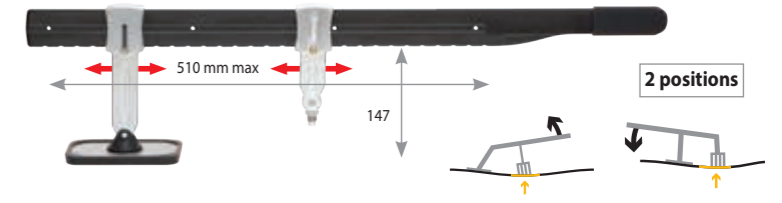

**Premium levelling bar**  
- Barre de débousselage Premium  
- Premium Zugbrücke

**059306**  
↓ 2.8 kg  
⊗ 79 x 30 x 13 cm / 3.2 kg

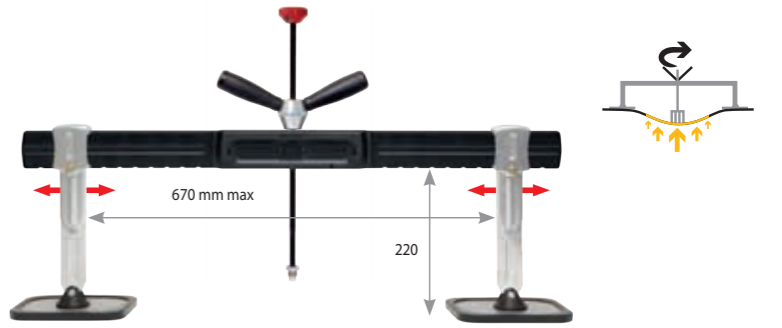

**Premium scissoring bar**  
- Barre de tirage Premium  
- Premium Scherenzugbrücke

**058996**  
↓ 3.1 kg  
⊗ 87 x 16 x 18 cm / 3.9 kg

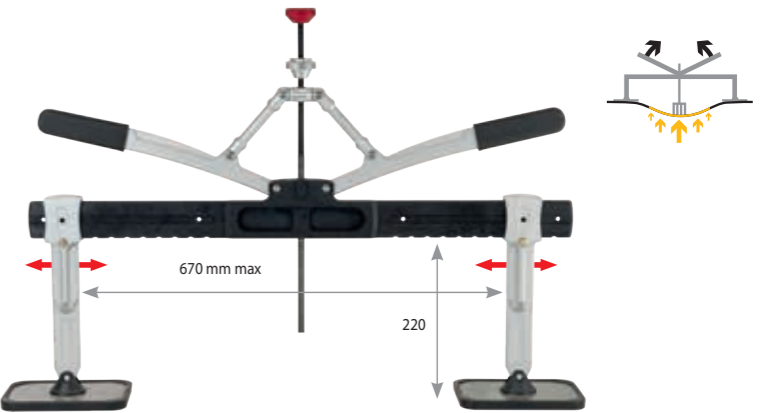

**Premium 1200 scissoring bar**  
- Barre de tirage 1200 renforcée Premium  
- Premium Scherenzugbrücke 1200

**059313**  
↓ 5.6 kg  
⊗ 127 x 26 x 9 cm / 6.2 kg

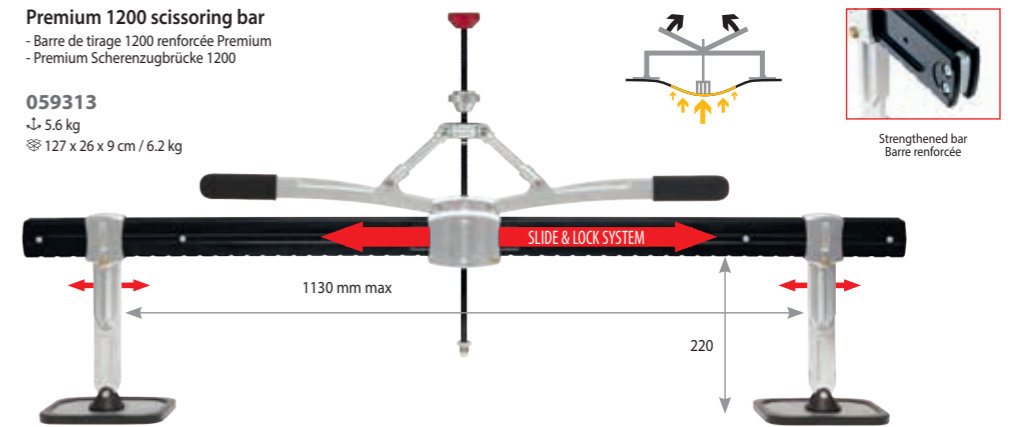

## OPTIONS

**Reinforced bar 1200 mm - Barre renforcée**  
051171  
1200 mm

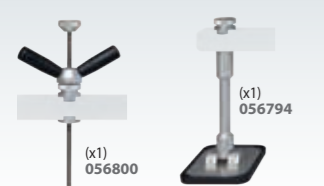
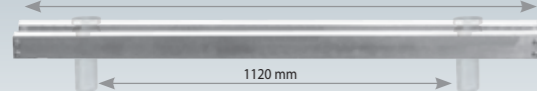

Fixing screw  
058439

**Double pads support**  
- Support double patin  
- Doppelpfüße  
050723



### STANDARD

**2 teeth hook**  
STANDARD  
057296

### STANDARD

PREMIUM (LONG FEET NEEDED)

**4 tooth claw**  
Ø M10 / M14  
049758

**6 tooth claw**  
Ø M10 / M14  
049734

**8 tooth claw**  
Ø M10 / M14  
049741



### PREMIUM

**2 teeth hook**  
PREMIUM  
059382

**3 teeth hook**  
PREMIUM  
059658



## OPTIONS



# ☆☆☆ SUPER ERGONOMIC



## QUICK HOOK

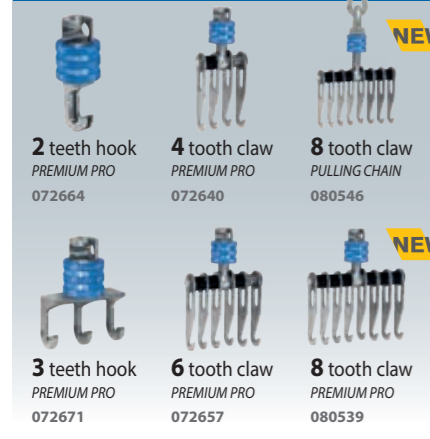

## EASY REMOVABLE PULLING SYSTEM

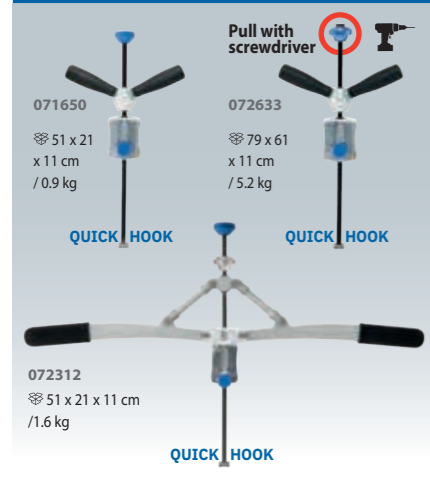

## SLIDE & LOCK



# PREMIUM PRO

### Premium Pro Levelling lever

- Levier de débosselage Premium Pro  
- Premium Pro Zughebel

072619  
↳ 1.6 kg  
⊗ 87 x 17 x 18 cm / 2.3 kg

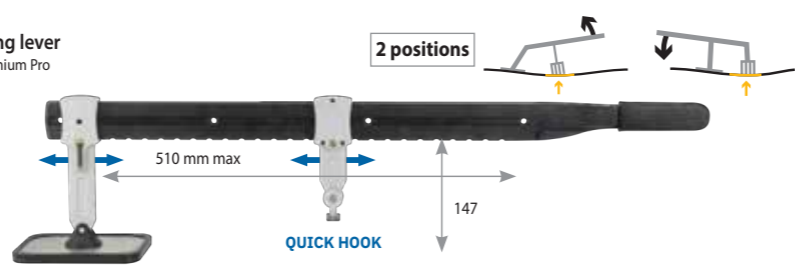

### Premium Pro Levelling bar 900mm / Single feet

- Barre de débosselage Premium Pro 900 mm  
- Premium Pro Zugbrücke 900 mm

071643  
⊗ 120 x 26 x 8 cm / 4.4 kg  
↳ 3.8 kg

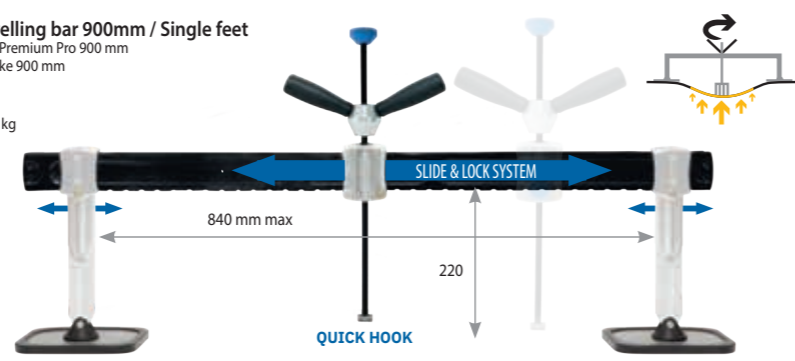

### Premium Pro Levelling bar 900mm / Double feet

- Barre de débosselage Premium Pro 900 mm  
- Premium Pro Zugbrücke 900 mm

080102  
↳ 3.8 kg

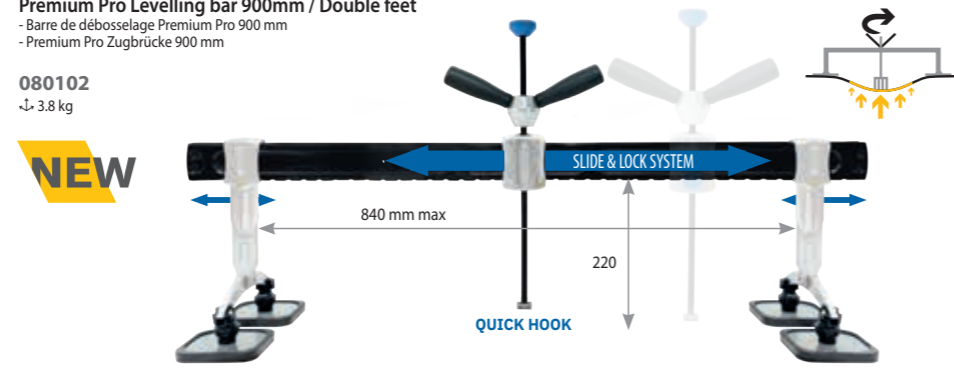

### Premium Pro Scissoring bar 900mm

- Barre de tirage Premium Pro 900 mm  
- Premium Pro Scherenzugbrücke 900 mm

072305  
⊗ 103 x 30 x 13 cm / 5.2 kg  
↳ 4.5 kg

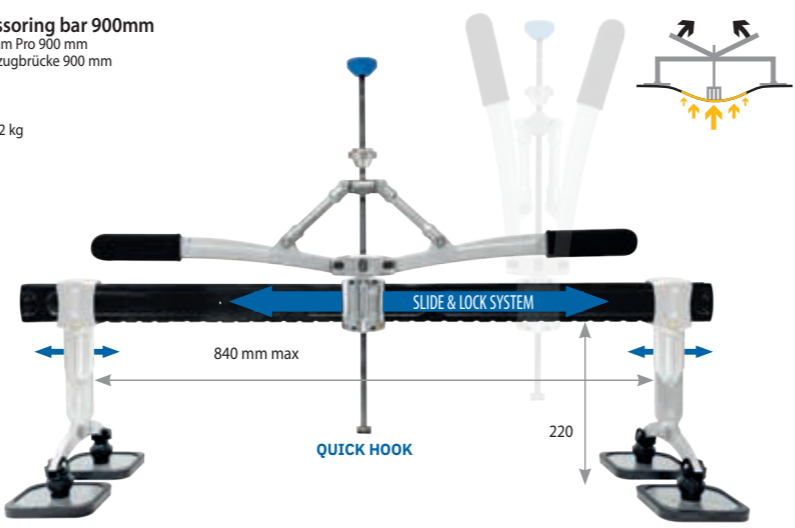

### Premium Pro Scissoring bar 1150 mm

- Barre de tirage Premium Pro 1150 mm  
- Premium Pro Scherenzugbrücke 1150 mm

072626  
⊗ 124 x 7 x 7 cm / 3.1 kg



## PREMIUM BAR SMARHAND

for Premium & Premium Pro  
072480





# DENT PULLING WORKSTATIONS

**A COMPLETE SOLUTION  
UNE SOLUTION COMPLÈTE  
KOMPLETTLÖSUNGEN**

## Compatibility

SPOT	Dent 600	Dent 1000	Universal 800	Weld 810	Weld 910	Dent 1600	Dent 1600 WD	Dentstation Pro WD
2600, 2700	✓	✓	✓	✓		✓		✓
34.02/04	✓	✓	✓	✓		✓		✓
39.02/04	✓	✓	✓	✓		✓		✓
PRO 230/400	✓	✓	✓	✓		✓		✓
EXPERT 230/400	✓	✓	✓	✓		✓		✓
ALU PRO FV	✓	✓	✓			✓		✓
COMBI 230 E.PRO						✓		✓
ARCPULL 200/350				✓	✓	✓		✓
COMBI ARCPULL						✓		✓
ARCPULL 700					✓	✓		✓

**Universal 800**  
↕ 83 x 48 x 60 cm  
17,6 kg  
☞ 15 x 52 x 80 cm  
18,1 kg  
051331

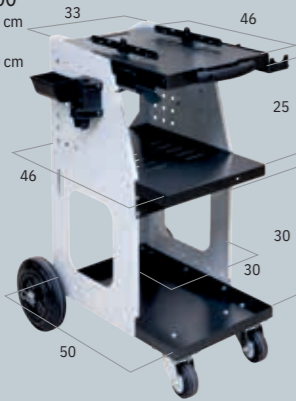

**Weld 810**  
↕ 84 x 50 x 77 cm  
20,1 kg  
☞ 14 x 80 x 51 cm  
21,6 kg  
037489

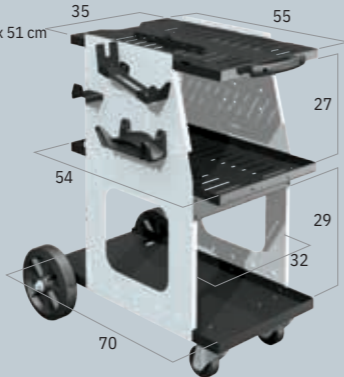

**Weld 910**  
↕ 84 x 52 x 89 cm  
25 kg  
☞ 22 x 80 x 52 cm  
27 kg  
070967

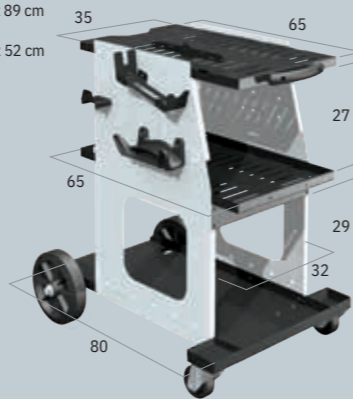

**Dent 1600**  
↕ 69 x 161 x 70 cm  
/ 35,8 kg  
☞ 103 x 22 x 66 cm  
/ 38,7 kg  
072596

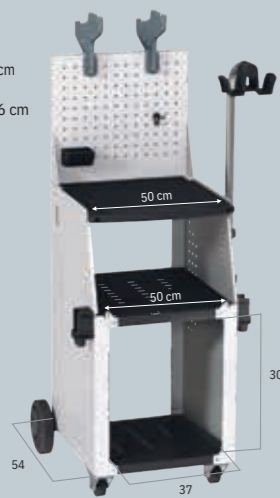

**Dent 1600 WD**  
↕ 71 x 161 x 70 cm  
/ 49,5 kg  
☞ 103 x 22 x 66 cm  
/ 52,4 kg  
072169

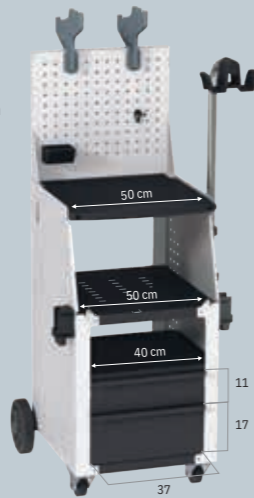

**Dentstation Pro WD**  
↕ 71 x 161 x 90 cm  
/ 65 kg  
☞ 120 x 28 x 80 cm  
/ 68,5 kg  
072800



## CHARIOTS / TROLLEYS

**Dent 600**  
↕ 44 x 62 x 35 cm / 6,9 kg  
☞ 60 x 14 x 39 cm / 7,4 kg  
072831



**Dent 1000**  
↕ 44 x 95 x 35 cm / 9,3 kg  
☞ 60 x 14 x 39 cm / 9,9 kg  
072848



## EASYLINER



EASYLINER 39.02

EASYLINER PRO 230

## PROLINER



PROLINER 39.02  
PROLINER 39.04

PROLINER PRO 230  
PROLINER PRO 400

PROLINER ALU PRO FV

PROLINER ARCPULL 200

### STEEL / ACIER / STAHL



GYSPOT  
(guns & consumables included)

### STEEL / ACIER / STAHL



GYSPOT  
(guns & consumables included)

### ALU



GYSPOT  
(guns & consumables included)

39.02	PRO 230	39.02	PRO 230	ALU PRO FV	ARCPULL 200
053618 ☞ : 058521	072398	035775	035799	035836	065260



#### INCLUDED ACCESSORIES



DENT 1000  
072848

Dent box easy  
053632

#### INCLUDED ACCESSORIES



UNIVERSAL 800  
051331  
+ Cable support  
052284

Dent box easy  
050037



Levelling bar double action  
053564

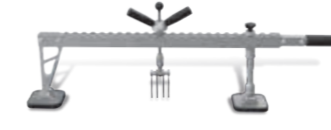

Levelling bar double action  
053564

#### INCLUDED ACCESSORIES



UNIVERSAL 800  
051331  
+ Cable support  
052284

#### INCLUDED ACCESSORIES



Weld 810  
037489  
+ Cable support  
052284



Alu puller  
051003



Arc puller premium  
065161



4 m³ support  
for Dent 1600 /  
1600 WD &  
Dentstation Pro WD  
059665



Cable support for  
Spot 800, 1600  
& Dentstation Pro WD  
052284



Protection cover - Housse de protection  
- Schutzhaube  
for Universal 800  
062733  
for Spot 1600 & Dent 1600  
048881  
for Dentstation Pro  
059870

# SPEEDLINER STANDARD

\*\*\*  
COMPLETE  
SYSTEM



PRO 230, 400      EXPERT 200, 230, 400      COMBI 230 E.PRO      ARCPULL 200 + PRO 230, 400      ARCPULL 200 + EXPERT 200, 230, 400      ALU PRO FV

## STEEL / ACIER / STAHL



GYSPT  
(guns & consumables included)



GYSPT  
(guns & consumables included)



GYSPT  
(guns & consumables included)



GYSPT  
(guns & consumables included)

PRO 230 074446	EXPERT 200 074460	COMBI 230 E PRO 074491	ARCPULL 200 + PRO 230 074507	ARCPULL 200 + EXPERT 200 074521	ALU PRO FV 074552
PRO 400 074453	EXPERT 230 074477		ARCPULL 200 + PRO 400 074514	ARCPULL 200 + EXPERT 230 074538	
	EXPERT 400 074484			ARCPULL 200 + EXPERT 400 074545	

### INCLUDED ACCESSORIES

DENT 1600 072596	Cable support 052284	Levelling bar 850 mm 050693      052451	
Magnetic earth 049666	Multihook heads 049758+049734	Levelling bar 050693	
Manuspot 050679	Dent box consumables 051515 3 lifting rods 050792	Ringmatic 052154	
Alu puller 051003	Cable support 052284	Arc puller premium 065161	Cable support 052284 + 4 m support 059665
Stainless steel brush 044258 Alu Box 05 & 6 048195	Infrared Thermometer 052994 Hot air gun 650°C 066311		

without generator (excluded Ringmatic) 035058

### INCLUDED ACCESSORIES

DENT 1600 072596	Cable support 052284
Levelling bar 850 mm 050693	
Alu hammers 020986	Set of pencil punches with 6 teflon tips 052888
Multihook heads 049758	Alu puller 051003
Stainless steel brush 044258 Alu Box 05 & 6 048195	Infrared Thermometer 052994 Hot air gun 650°C 066311

# SPEEDLINER PREMIUM

★★★★  
COMPLETE SYSTEM



PRO 230, 400



EXPERT 200, 230, 400



COMBI 230 E.PRO



ARCPULL 200  
+ PRO 230, 400



ARCPULL 200  
+ EXPERT 200, 230, 400



ARCPULL 200, 350

## STEEL / ACIER / STAHL



GYSPOT  
(guns & consumables included)



COMBI 230 E PRO  
(guns & consumables included)



ARCPULL 200 + PRO 230  
(guns & consumables included)



ARCPULL 200  
(guns & consumables included)

PRO 230 073883	EXPERT 200 073906	COMBI 230 E PRO 073968	COMBI ARCPULL 074569	ARCPULL 200 + PRO 230 073975	ARCPULL 200 + EXPERT 200 073913	ARCPULL 200 073999	ARCPULL 350 074934
PRO 400 073890	EXPERT 230 073920			ARCPULL 200 + PRO 400 073982	ARCPULL 200 + EXPERT 230 073937	077317 (without HOT AIR GUN)	
	EXPERT 400 073944				ARCPULL 200 + EXPERT 400 073951		

### INCLUDED ACCESSORIES

DENT 1600 WD 072169	Cable support 052284	Premium levelling bar 720 mm 059306
Hook head 049758 + 059658 + 059382	Premium levelling lever 059290	
Magnetic earth 049666	Manuspot 050679	Dent box consumables 051515 + 3 lifting rods 050792
Manual pulling handle 057289 Ringmatic 052154		

### INCLUDED ACCESSORIES

DENT 1600 WD 072169 Cable support 052284	Alu Ring Box 1 mm 059412 Alu Ring Box 1,5 mm 059429 Premium 2-teeth hook 059382
Arc puller premium 065161	Premium levelling bar 720 mm 059306
Alu hammers 020986	Infrared Thermometer 052994 Hot air gun 650°C 066311
Set of pencil punches with 6 teflon tips 052888	3 lifting rods 050792 Ring holder 059610
Stainless steel brush 044258	4 m³ support 059665

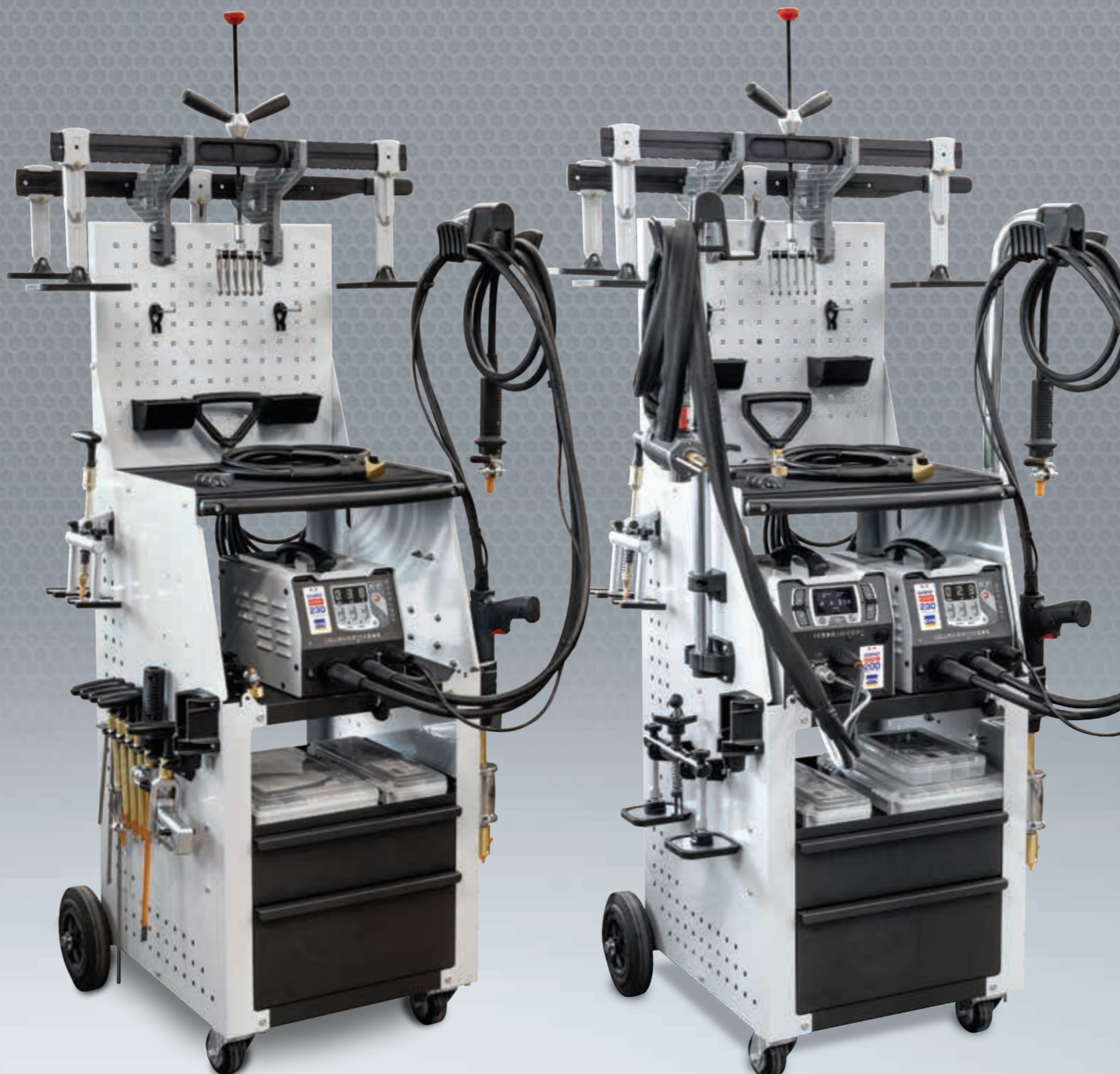

# SPEEDLINER PREMIUM PRO



PRO 230, 400



EXPERT 200, 400  
+ ARCPULL 200, 350



COMBI ARCPULL



ARCPULL 200, 350

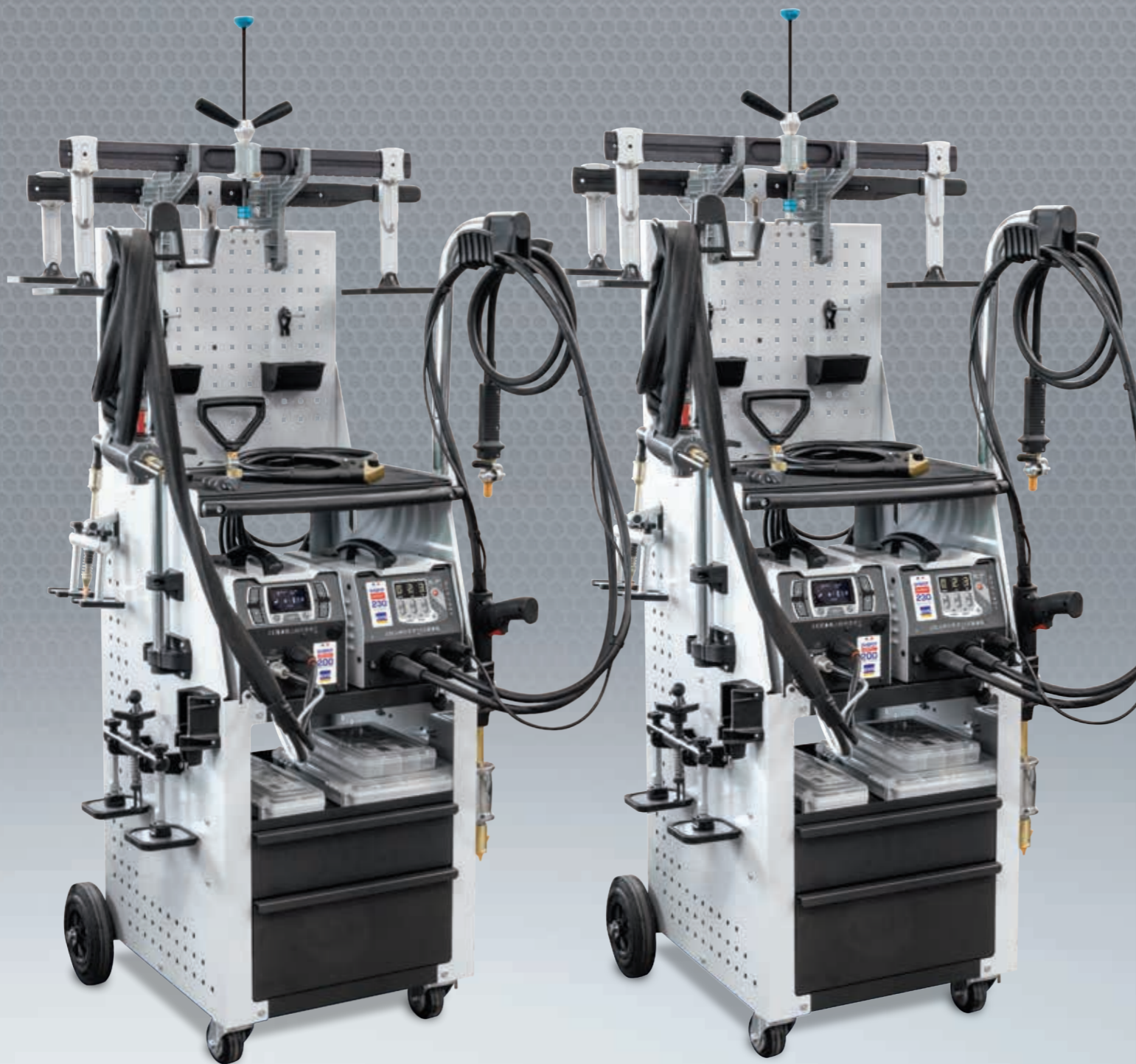

## STEEL / ACIER / STAHL



GYSPOT  
(guns & consumables included)

## ALU + STEEL / ACIER / STAHL



GYSPOT  
(guns & consumables included)

GYSPOT  
(guns & consumables included)

## ALU



GYSPOT  
(guns & consumables included)

EXPERT 230	EXPERT 400	EXPERT 400 + ARCPULL 200	EXPERT 400 + ARCPULL 350	COMBI ARCPULL	ARCPULL 200	ARCPULL 350
080201	080218	080232	080249	080225	080256	080263
		EXPERT 200 + ARCPULL 200				
		080553				

### INCLUDED ACCESSORIES

Dent 1600 WD 072169	Premium Pro levelling bar 900 mm 071643
Ringmatic 052154	Manuspot 050679
Manual pulling handle 057289	3 lifting rods 050792 Dent box consumables 051515
Premium Pro teeth hook 072671 + 072664 + 072640	Magnetic earth 049666

### INCLUDED ACCESSORIES

Dent 1600 WD 072169	Alu Ring Box 1 mm 059412 Alu Ring Box 1.5 mm 059429
Ring holder 059610	4 m³ support 059665
Premium Pro levelling bar 900 mm 071643	Arc Puller Premium Pro 072572
Set of pencil punches with 6 teflon tips 052888	Infrared Thermometer 052994 Hot air gun 650°C 066311
Alu hammers 020986	Stainless steel brush 044258
Cable support 052284 4 m³ support 059665 Arc Puller Premium Pro 072572	3 lifting rods 050792



# DENTSTATION STANDARD



## STEEL / ACIER / STAHL



39.02	PRO 230	EXPERT 200
078161	078208	078321
39.04	PRO 400	EXPERT 230
078185	078260	078369
		EXPERT 400 078444

## ALU + STEEL / ACIER / STAHL



COMBI 230 E PRO	ARCPULL 200 + PRO 230	ARCPULL 200 + EXPERT 200
078529	078222	078338
	ARCPULL 200 + PRO 400	ARCPULL 200 + EXPERT 230
	078284	078384
		ARCPULL 200 + EXPERT 400 078468



### INCLUDED ACCESSORIES

<p>x6    x2</p>	<p>Double pads 050723</p>	<p>Levelling bar 850 mm 050693</p>	<p>Scissoring bar 050716</p>
<p>Dentstation Pro WD 072800 Fixing kit 051362</p>	<p>Multihook heads 049758 +049734 +049741</p>	<p>Levelling lever 050686</p>	<p>Strengthened bar 1200 mm 051171 Extensions (x2) 052451</p>
<p>Magnetic earth 049666</p>	<p>Manuspot 050679</p>	<p>Dent box consumables 051515 3 lifting rods 050792 Empty box 320x113mm</p>	<p>Manual pulling handle 057289</p>
<p>Fast pulling rings (x5) 058712 + Alu puller 051003</p>	<p>Cable support 052284</p>	<p>Arc puller premium 065161</p>	<p>Cable support 052284 + 4 m<sup>3</sup> support 059665 + Flanges (x 2) 062146</p>

# DENTSTATION PREMIUM



PRO 230, 400



EXPERT 200, 230, 400



COMBI 230 E.PRO  
COMBI ARCPULL



ARCPULL 200  
+ PRO 230, 400



ARCPULL 200  
+ EXPERT 200, 230, 400

★★★★  
COMPLETE  
SYSTEM

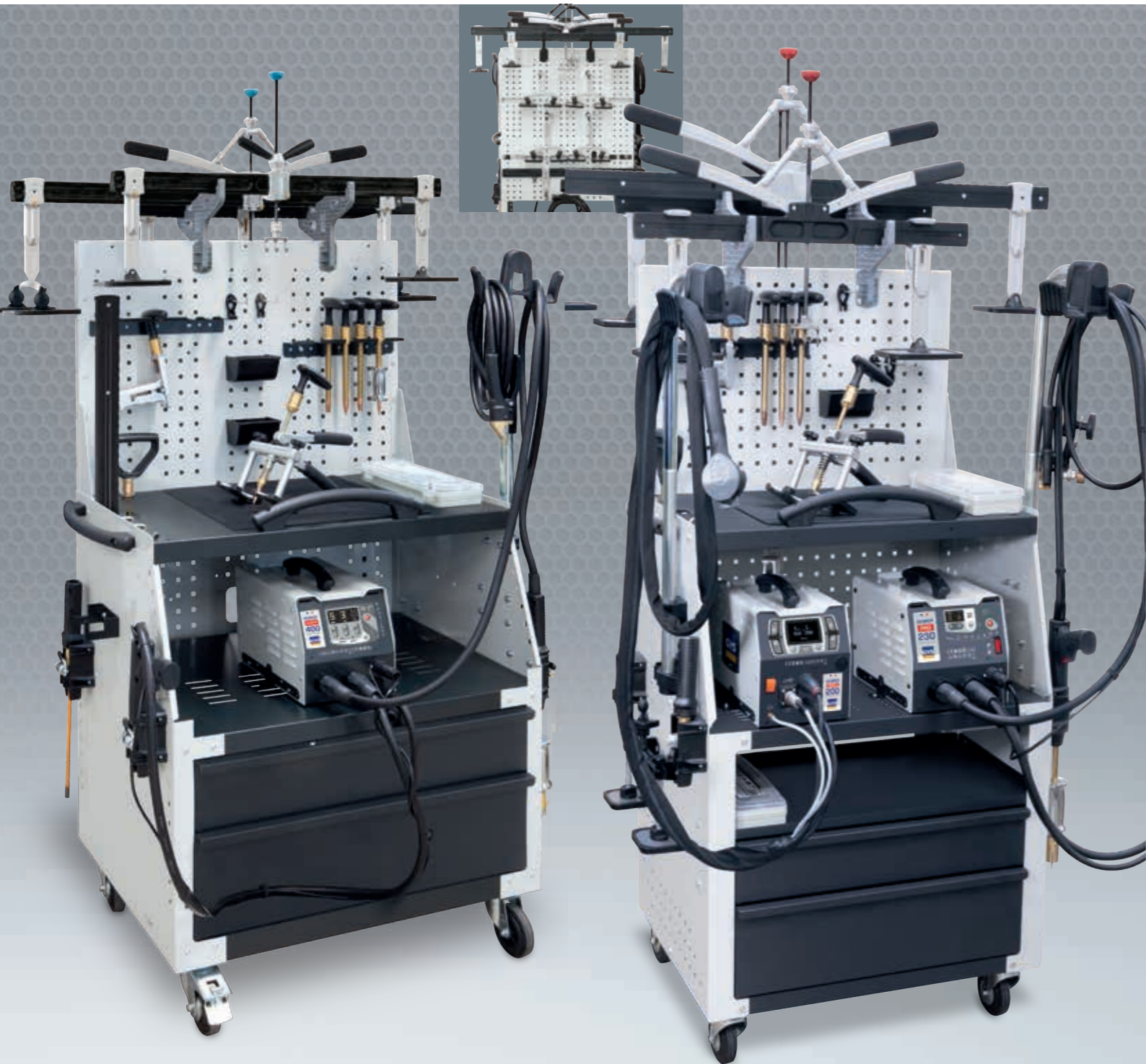

## STEEL / ACIER / STAHL



GYSPOT  
(guns & consumables included)

## ALU + STEEL / ACIER / STAHL



GYSPOT  
(guns & consumables included)



GYSPOT  
(guns & consumables included)

<b>PRO 230</b> 078239	<b>EXPERT 200</b> 078345	<b>COMBI 230 E PRO</b> 078543	<b>COMBI ARCPULL</b> 078567	<b>ARCPULL 200 + PRO 230</b> 078253	<b>ARCPULL 200 + EXPERT 200</b> 078352
<b>PRO 400</b> 078291	<b>EXPERT 230</b> 078406			<b>ARCPULL 200 + PRO 400</b> 078314	<b>ARCPULL 200 + EXPERT 230</b> 078420
	<b>EXPERT 400</b> 078482				<b>ARCPULL 200 + EXPERT 400</b> 078505

### INCLUDED ACCESSORIES

x6 x2	Manuspot 050679	Premium levelling bar 720 mm 059306	Premium levelling lever 059290
Dentstation Pro WD 072800 Fixing kit 051362	Hook head 049734 + 059658 + 059382	Premium scissoring bar 720 mm 058996	Premium scissoring bar 1200 mm 059313
Magnetic earth 049666	Premium double pads support 150 mm (x2) 059351 + 220 mm (x2) 059375	Dent box consumables 051515 3 lifting rods 050792 Empty box 320x113mm	Manual pulling handle 057289
		Ringmatic 052154	

Fast pulling rings (x5) 058712 Alu puller 051003 Cable support 052284	Cable support 052284 4 m <sup>2</sup> support 059665 Flanges (x 2) 062146 Arc puller premium 065161	Arc puller premium 065161	Cable support 052284 4 m <sup>2</sup> support 059665 Flanges (x 2) 062146
--	--	------------------------------	--

WORKSTATIONS  
DENT PULLING



# DENTSTATION PREMIUM PRO



EXPERT 230, 400



COMBI ARCPULL



EXPERT 400  
+ ARCPULL 200, 350



ARCPULL 200, 350

## STEEL / ACIER / STAHL



1 BOX GYSPOT (guns & consumables included)

## ALU + STEEL / ACIER / STAHL



1 BOX GYSPOT (guns & consumables included)

## ALU



1 BOX GYSPOT (guns & consumables included)

EXPERT 230	EXPERT 400	EXPERT 400 + ARCPULL 200	EXPERT 400 + ARCPULL 350	COMBI ARCPULL	ARCPULL 200	ARCPULL 350
080133	080140	080164	080171	080157	080461	080478

### INCLUDED ACCESSORIES



1 BOX Dentstation Pro WD 072800



Premium pro levelling bar 900mm 071643



Premium pro levelling lever 072619  
Premium pro bar 1184 mm 072626



Manuspot 050679

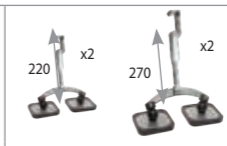

x2 220 x2 270  
(x2) 059375 + (x2) 072688



072664 + 072671 + 072640 + 072657



071650 + 072312  
Double padded feet 270 mm 072688

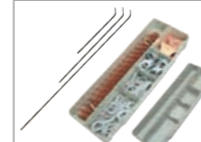

Dent box consumables 051515  
3 lifting rods 050792  
Empty box 320x113mm



Magnetic earth 049666  
Ringmatic 052154  
Manual pulling handle 057289

1 BOX STEEL ACCESSORIES PACK V2 080126



Cable support 052284



4 m³ support 059665



Arc Puller Premium Pro 072572

1 BOX ALU ACCESSORIES PACK 073838



Ring holder 059610  
Alu Ring Box 1,5 mm 059429

### INCLUDED ACCESSORIES



1 BOX Dentstation Pro WD 072800

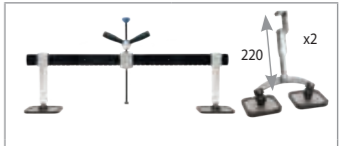

Premium pro levelling bar 900mm 071643 (x2) 059375



072664 + 072640 + 071650



059412  
Alu Ring Box 1,5 mm 059429



Alu hammers 020986



Arc Puller Premium Pro 072572



Set of pencil punches with 6 teflon tips 052888



3 lifting rods 050792  
Ring holder 059610



Stainless steel brush 044258  
Infrared Thermometer 052994  
Hot air gun 650°C 06631



4 m³ support 059665

1 BOX ARCPULL ACCESSORIES PACK 080485



# PULLING SYSTEMS



AIRFIX DRAW ALIGNER	39
DRAW ALIGNER	40
FRAME STRAIGHTENING	42



## DRAW ALIGNER

### AIRFIX DRAW ALIGNER

Air 5-8 bars

077379



### 350 kg Uniform pulling force

Force de tirage uniforme  
Gleichmäßige Zugkraft  
Forza di spinta uniforme



**NEW**



- Designed for
- ★ Time saving
  - ★ Maximum grip
  - ★ Durability

Ground anchor by suction  
**Fast installation**  
Ancrage au sol par aspiration :  
installation rapide  
Verankerung durch Vakuumbildung -  
schnell einsatzfähig  
Ancoraggio a terra: installazione rapida

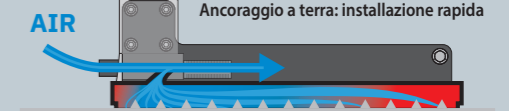

#### Precision

All directions

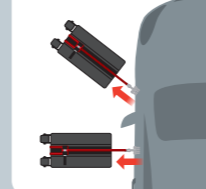

#### Down-pulling

Rocker panel  
- Bas de caisse  
- Schweller  
- Sottoporta



#### 4 pads

### Seal protection Perfect stability

4 patins : protection du joint, stabilité parfaite  
4 Pads: Dichtungsschutz, perfekte Stabilität  
4 piedini: protezione sigillata, perfetta stabilità



Seal - Joint - Rahmen - Guarnizione

#### Quick & easy set up



Compact  
& light  
31 kg



#### Low noise

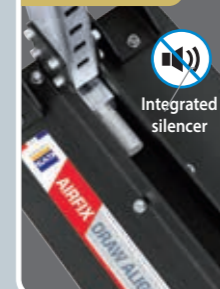

Integrated  
silencer

#### Smart maintenance

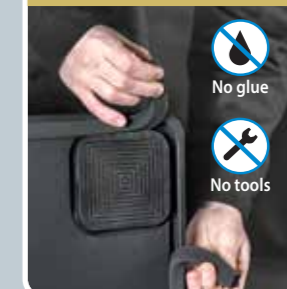

No glue



No tools



# PULLING SYSTEMS



Youtube

**DRAW ALIGNER**

Draw aligner - Équerre de tirage - Schnellausbeul-Richtausleger 052475

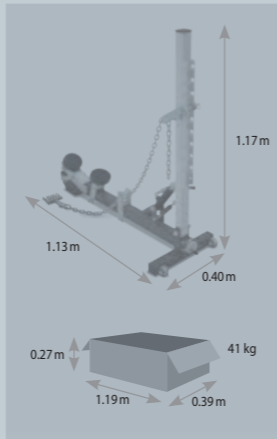
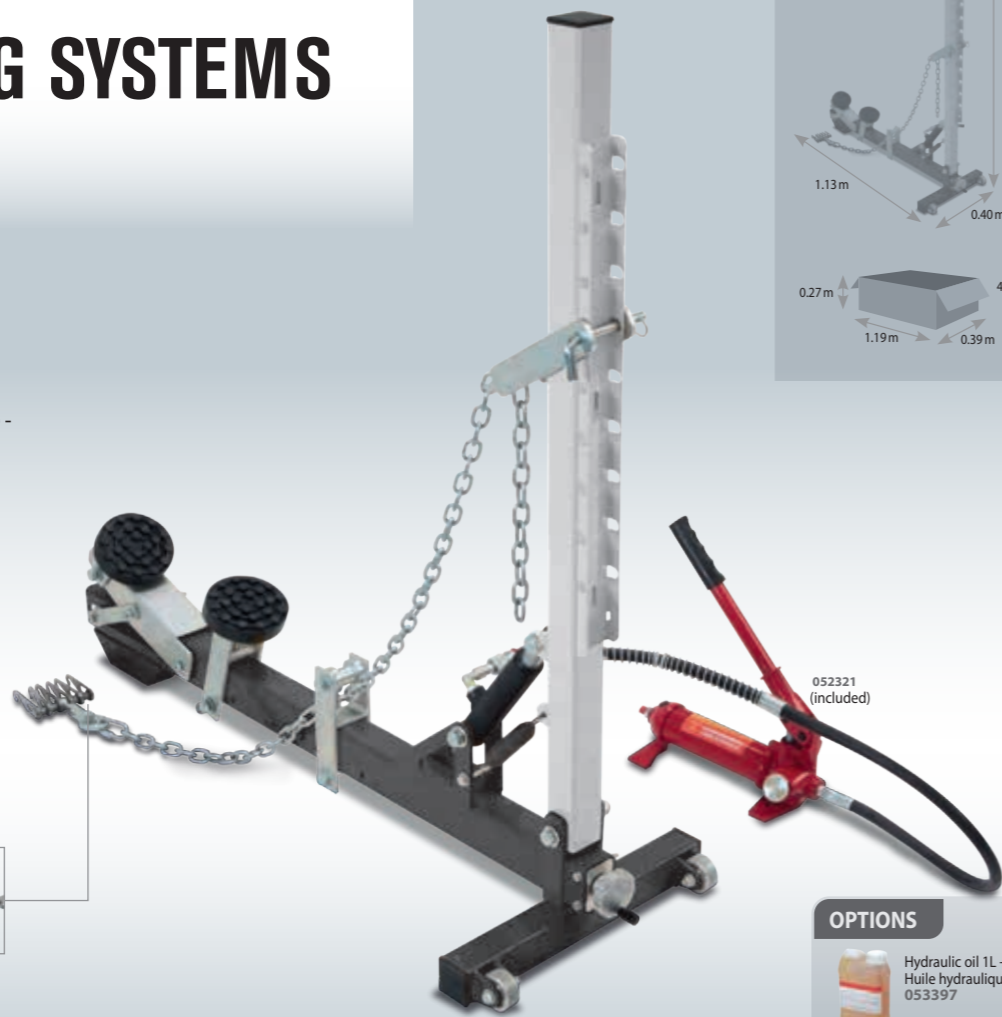
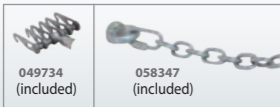
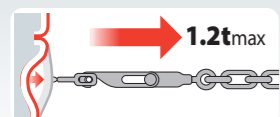
**OPTIONS****INCLUDED**

Wedge for rocker panel - Cône pour bas de caisse

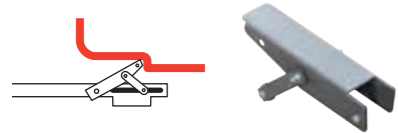

Pads kit for rocker panel - Kit patins pour bas de caisse

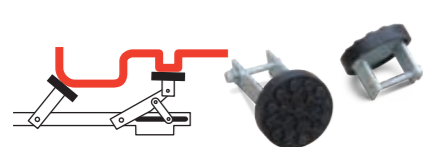
**OPTIONS**

Rocker panel arms for draw aligner - Bras de bas de caisse - Abstütztraverse für Richtausleger

052581

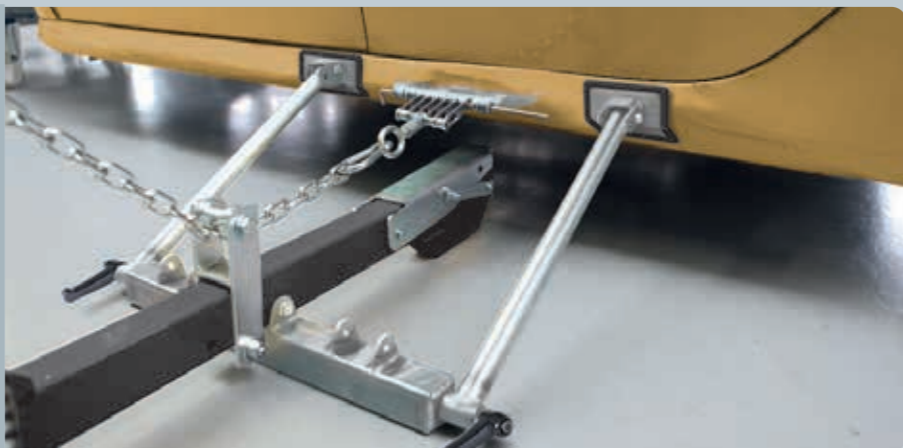
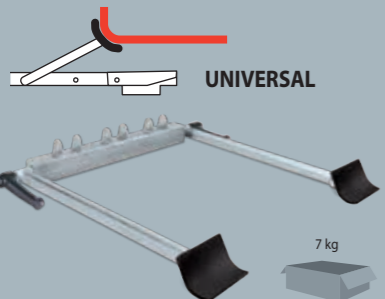
**DRAW ALIGNER PRO**

069244

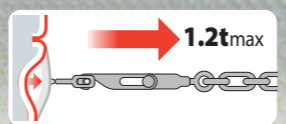

049734 (included) 058347 (included)

**OPTIONS****INCLUDED**

Plate under the wheel - Cône sous roue Compatible with Draw Aligner &amp; Draw Aligner Pro 076693



Wedge for rocker panel - Cône pour bas de caisse

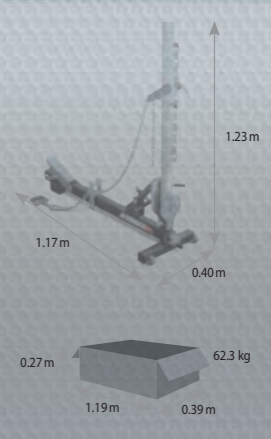
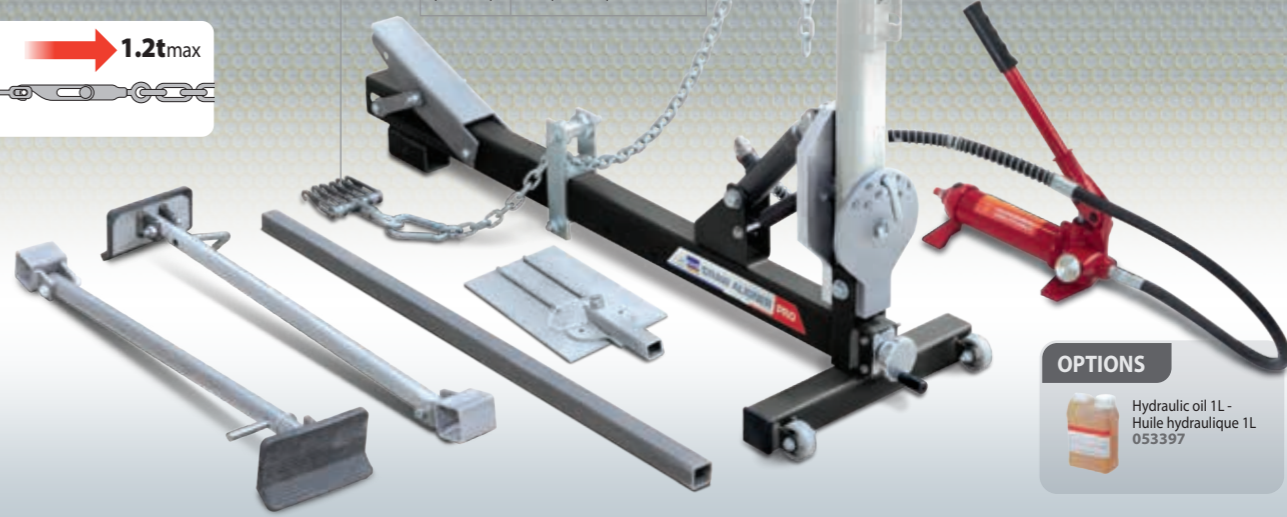
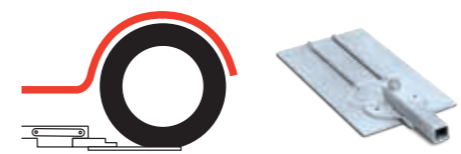

Rocker panel arms and stabilisation bar - Kit bras de bas de caisse et barre de stabilisation

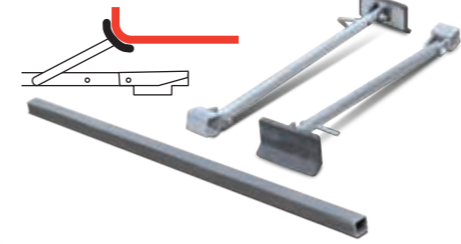
**OPTIONS**

Pads kit for rocker panel - Kit patins pour bas de caisse 071278



## SMART PULLER SILVER PULLING SYSTEM

- Système de tirage Smart puller silver - Schnellausbeul-Richtausleger Smart puller silver

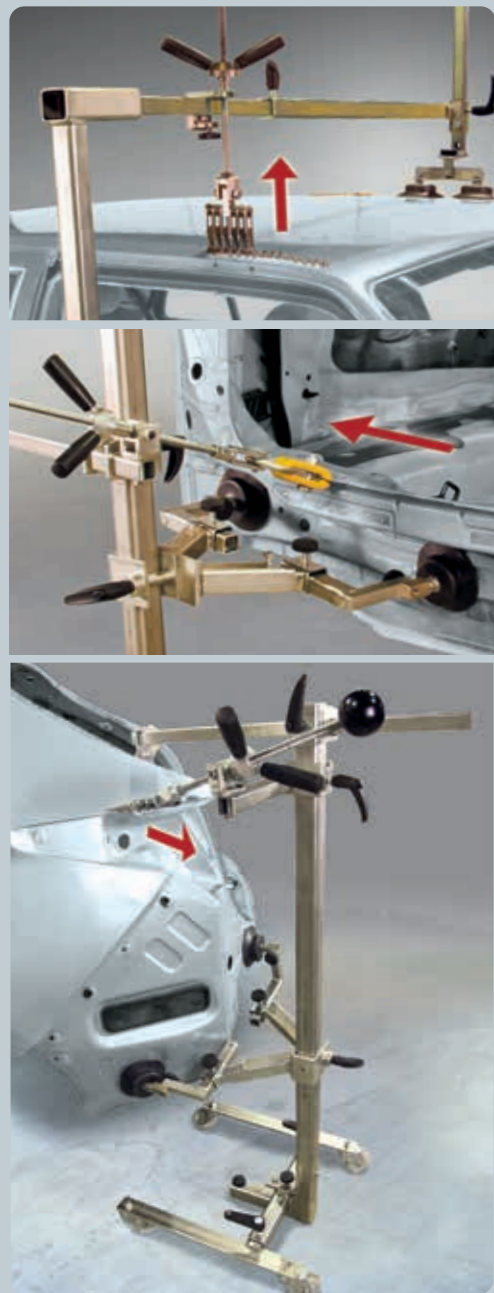

054820



- Doors - Portières - Türen
- Supports - Montants - Scheibenrahmen
- Hood/Bonnet - Capot - Haube
- Armature - Armature - Rahmen
- Rocker panel - Bas de caisse - Schweller
- Wings - Ailes - Kotflügel
- Roof - Toit - Dach
- Hatchback - Hayon - Heckdeckel

min: 0.60 m  
max: 2 m

min: 1.50 m  
max: 2.70 m

0.55 m

0.20 m

1.55 m

0.35 m

54 kg

**Autorobot**

### INCLUDED

Accessories

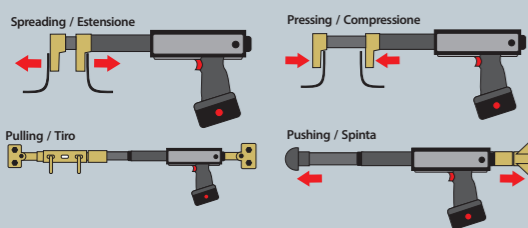
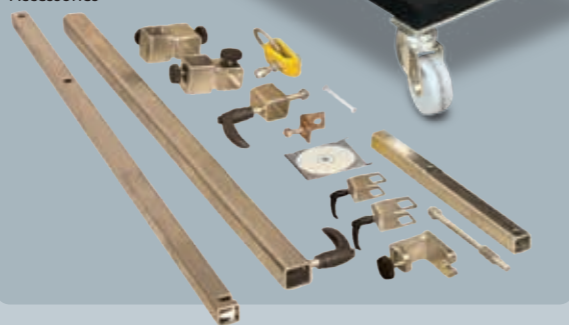

Applications / Applicazioni

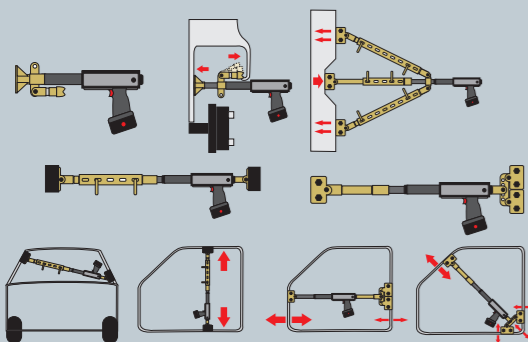

## ELECTRO POWER - Zug-Druckpresse

Non commercialisable en France

### OPTION

Pince écarteur 079496

**NEW**



with accessories : 057425

• PULLING POWER: 5 Ton.  
• PUSHING POWER: 5 Ton.  
• PISTON  
• STROKE: 130 mm



### INCLUDED

Standard kit : 425x620x210 mm  
Standard kit  
Total weight: 18 kg

057401

### INCLUDED

Accessories kit : 425x620x150 mm  
Accessories kit  
Total weight: 20 kg

057418

Li-Ion battery (included) 058514

## HYDRAULIC CYLINDER KIT - Coffret vérin hydraulique - Hydraulischer Drucksatz

MADE IN CHINA

**BASIC 4T**  
052345



**BASIC 10T**  
052338



**PRO 4T**  
057432



**PRO 10T**  
057449



### OPTIONS

Hydraulic oil 1L - Huile hydraulique 1L 053397

## ANCHOR BAR - Barre d'ancrage - Türspanner

MADE IN TAIWAN

053045



053052

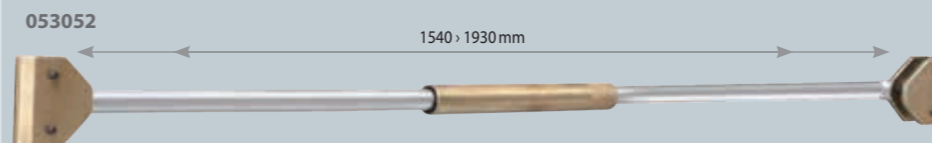

## MEASURING TOOLS - Mesures - Vermessung

BODYMETER, Mechanical measurements

052130

250 > 2230 mm



GYSMETER, Electronic measurements

052093

Measuring report

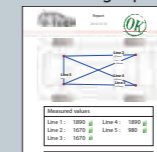

400 > 2650 mm

**SWIVEL CLAMP**  
- Pince pivotante

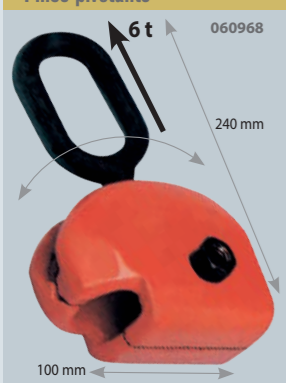

**PULL CLAMPS - Pincas de tirage - Ziehwerkzeuge**

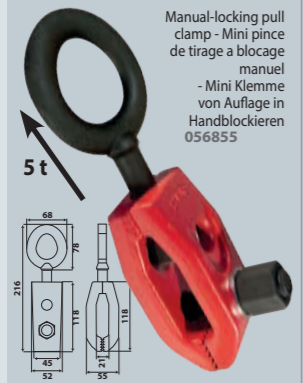

**PULL HOOK - Crochet de tirage - Ziehwerkzeuge**

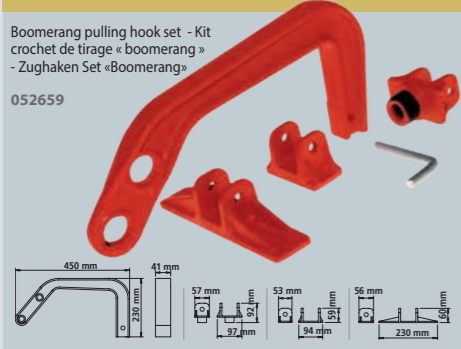

**ARCH HOOKS - Passage de roue**

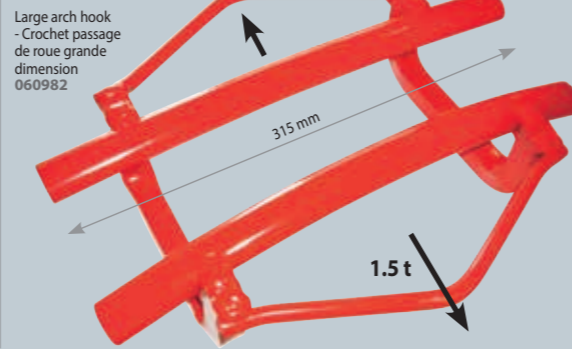
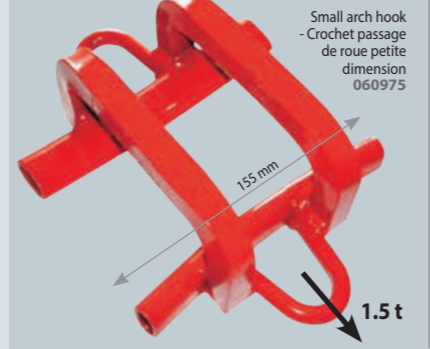

**PULLING CHAIN - Chaînes de tirage - Ziehwerkzeuge**

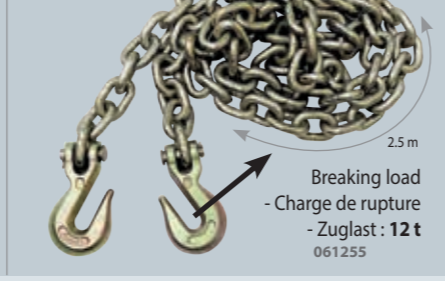
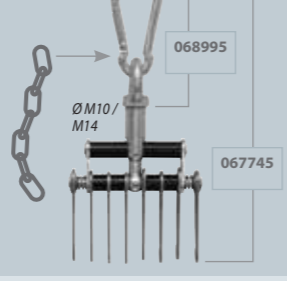
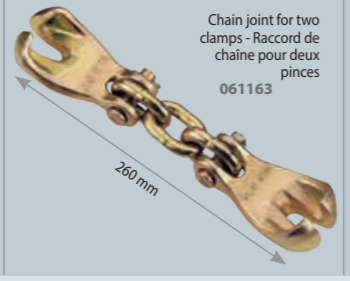
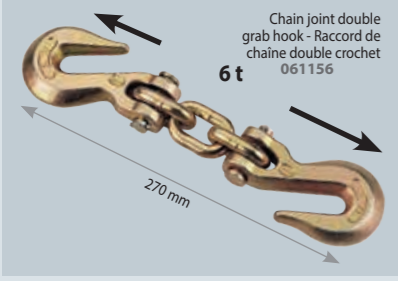

**WIDE PULL CLAMPS - Pincas de tirage larges**

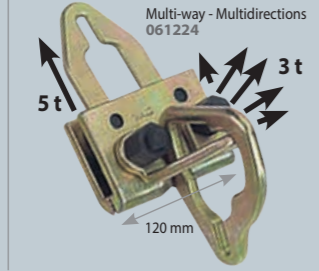
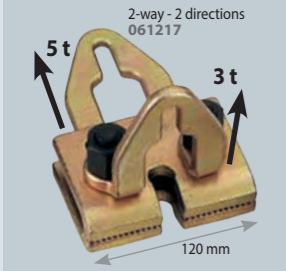

**SMALL PULL CLAMPS - Pincas de tirage faible largeur**

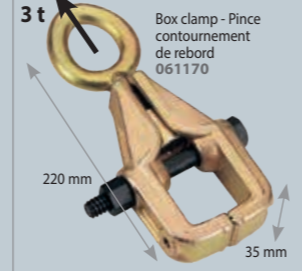
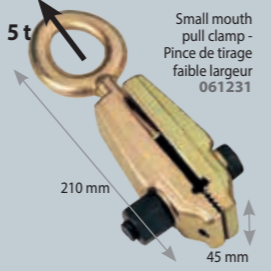
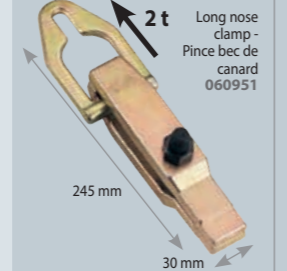

**MULTIPLE PULL CLAMP**  
- Pince de tirage multiple

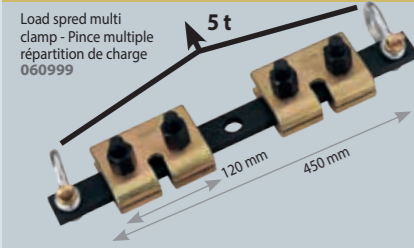

**45 MM SCISSORS CLAMP**  
- Pince ciseaux largeur 45 mm

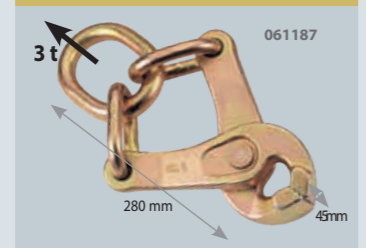

**90 DEGREE CORNER CLAMP**  
- Pince de tirage pour angle 90°



**C TYPE CLAMP**  
- Pince de tirage type C



**INERTIA HAMMER KIT - Kit marteau à inertie - Ausziehhammer kit**

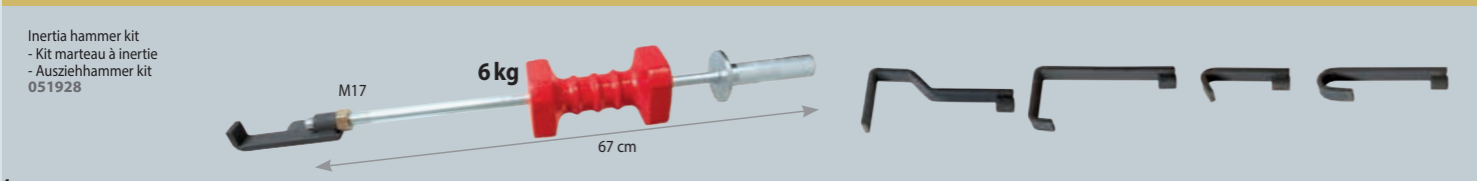

**SMART SATELLITE - Satellite intelligent- Satellite Komplett-Kit**

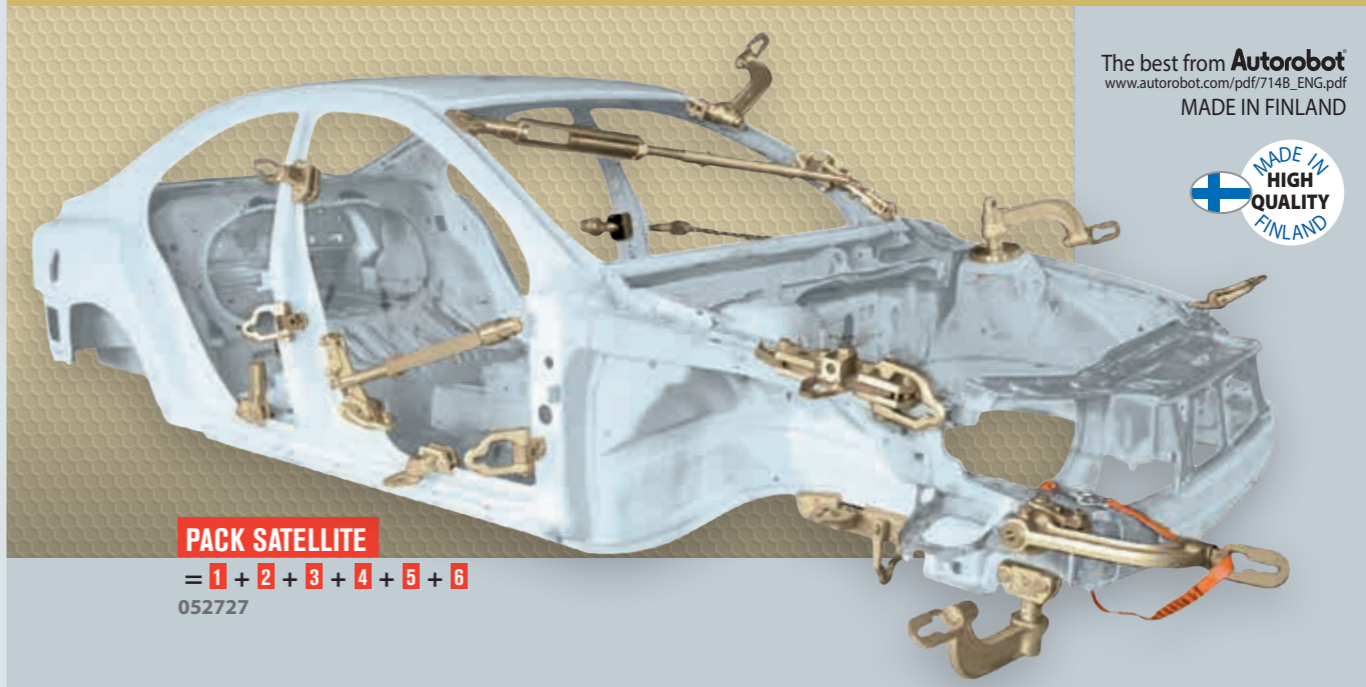

The best from **Autorobot**  
www.autorobot.com/pdf/7148\_ENG.pdf  
MADE IN FINLAND



**PACK SATELLITE**  
= 1 + 2 + 3 + 4 + 5 + 6  
052727

**1 SATELLITE**  
- Satellite - Satellite Basisbügel-Set



**2 KIT MAC PHERSON (A)**  
- Mac Pherson Kit - Befestigungs-Kit-Federbein (McPherson)



**3 BARRE POUR TIRER/POUSSER**  
- Push/Pull Bar - Zug/Druck-Stangenset

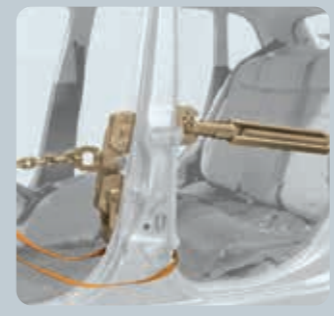
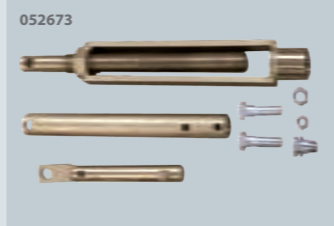

**4 SATELLITE (B)**  
- Bügelverlängerung

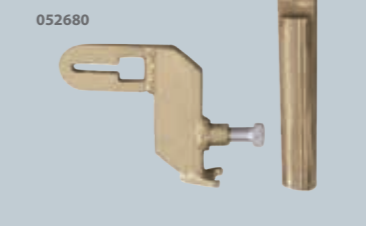

**5 SANGLE DE SÉCURITÉ**  
- Safety Strap - Sicherungsgurt



**6 DOUBLE PINCE SATELLITE (C)**  
- Double Clamp Satellite - Satellite Doppelklemme



**PINCE DE TIRAGE MULTI-USAGE**  
- Versatile pulling clamp - Multifunktions-Zugklemme

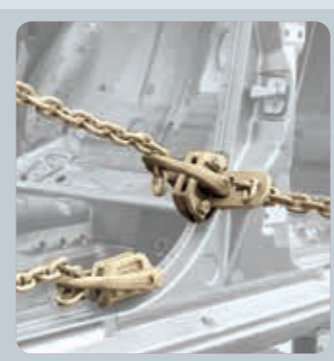

**POWER-PULLER 4T**

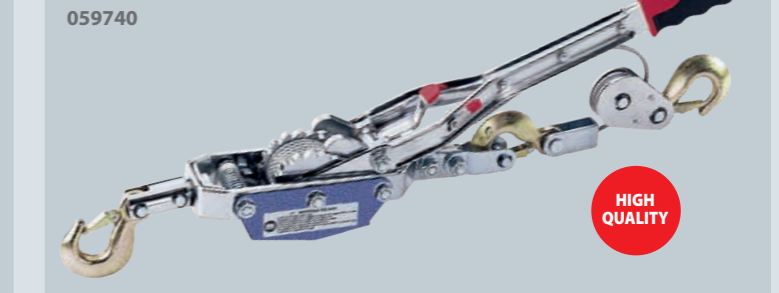

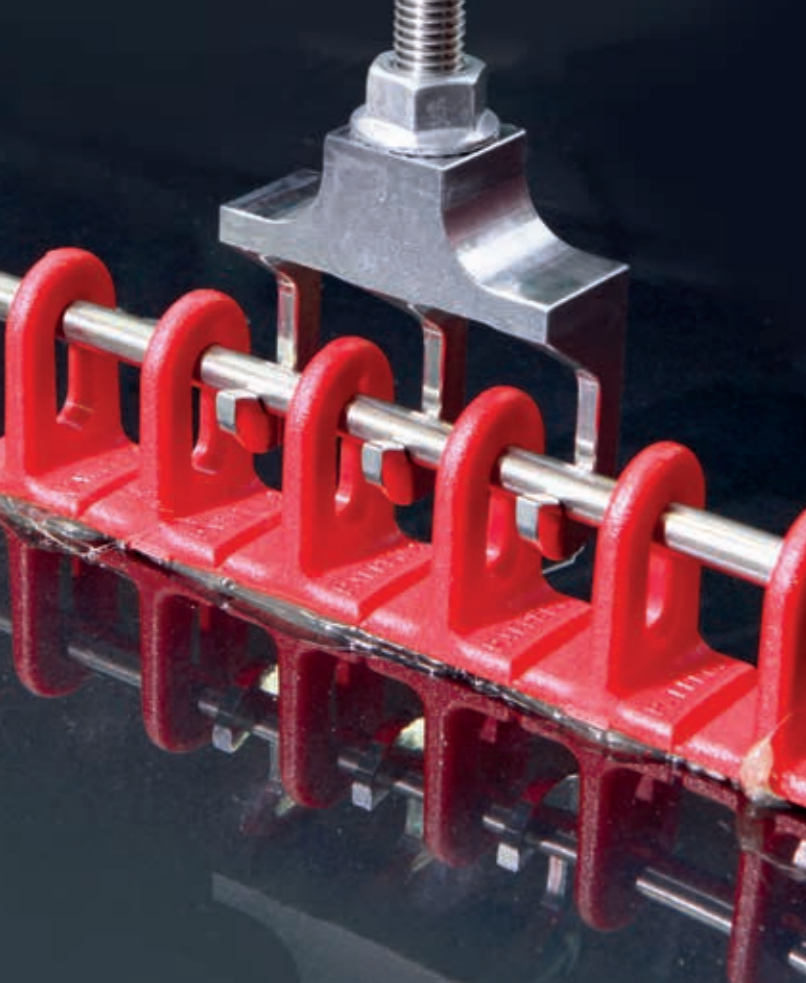

# PAINTLESS DENT REPAIR

## DENT PULLING INDUCTOR

- Inducteur débosselage - Dellenmatrix

GYS  
DUCTION  
AUTO + Dent pulling  
inductor  
054776

= GYS  
DUCTION AUTO  
DENT REPAIR  
054981

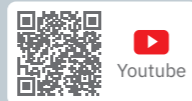

Licensed by  
BETAG.Innovation

🔌	🔌	⚡	Freq.	INTEGRATED TECHNOLOGY	❄️	Cable (m)	📦	⚙️
50 Hz	A	W	kHz	PFC	FV	Liquid Cooling	Inductor	LxWxH cm / kg
230V, 1~	16	2 400	35+120	▪	▪	—	2 2.5	52 x 30 x 37 / 9.4
								37 x 21 x 37 / 7.5

## DENT PULLING INDUCTOR

- Inspection carrosserie  
- Ausbeul Induktor

Planche flexible pour inspection  
de la carrosserie - Ausbeul-  
Matrix  
Ø 800 mm  
059122

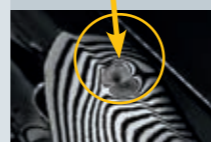

OPTION  
Freezer spray  
- Spray refroidisseur  
-50 °C  
400 ml  
(x 12)  
048898

## PAINTLESS DENT REPAIR MAGNETIC KIT

- Kit magnétique de débosselage sans peinture  
- Magnetisches Ausbeul-Kit

053168

EXELTOOLS



1010 mm - 40"

705 mm - 28"

610 mm - 24"

510 mm - 20"

## PAINTLESS DENT REPAIR LAMPS

- Lampes de débosselage  
- Ausbeullampe

ULTRA LIGHT CARBON X40 PW  
053175

EXELTOOLS



150 mm  
- 6"

300 mm - 12"

## DENT PULLING KIT (PAINTLESS)

- Kit débosselage sans peinture - Dellenausbeulhebel-Set

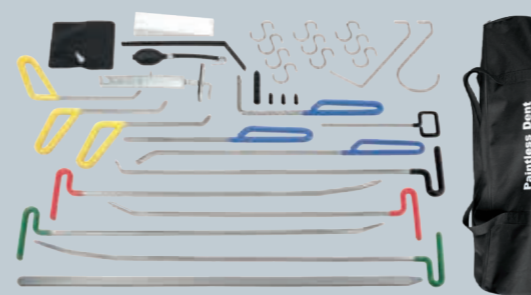

33  
parts

051959

## SET OF 6 PENCIL PUNCHES

- Kit de 6 coins de frappe - Beulenstemmer-Satz mit 6 Tefloneinsätzen

052888

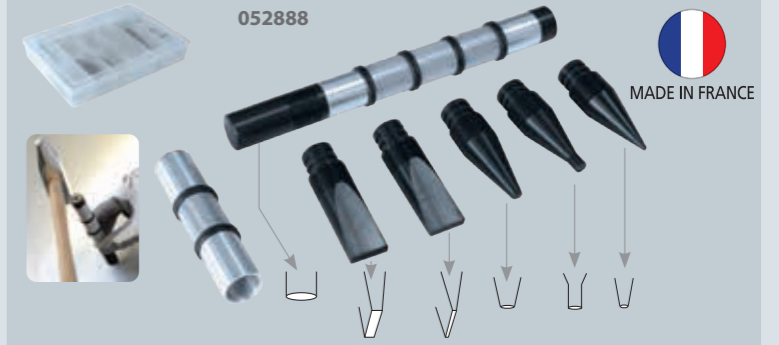

## PNEUMATIC INERTIA HAMMER

- Marteau inertie pneumatique - Unterdruck-Schlaghammer

2.5 kg

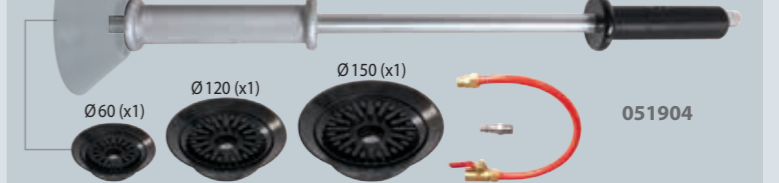

Ø 60 (x1)

Ø 120 (x1)

Ø 150 (x1)

051904

## AIR CUSHION KIT

- Kit coussins gonflables - Luftpolster-Spreizkissen-Satz



051942

## PUMP AIR SUCTION SLIDE HAMMER

- Marteau à inertie à ventouses (pompage manuel) - Man. Unterdruck-Schlaghammer

1,1kg



Ø 75 (x1)

Ø 100 (x1)

Ø 125 (x1)

048683





PDR: Paintless Dent Repair  
 - Débosselage rapide et sans peinture  
 - Lackschadenfreies Ausbeulen

# PAINTLESS DENT REPAIR

## BARRETTES ANNEAUX PLASTIQUE Plastic Multipads Ösen-Klebe pads

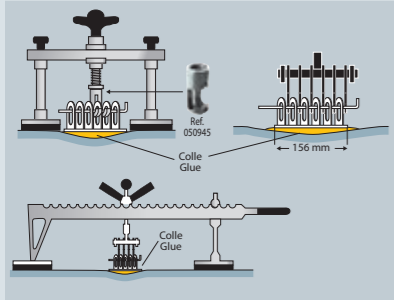
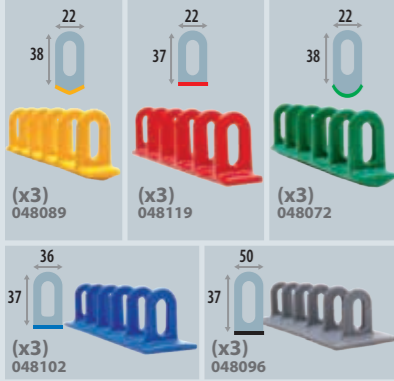

## GLUE PULLING KITS

### GYSMART GLUE PULLING KIT

NEW



### GYSMART GLUE PULLING KIT PLUS

NEW



Workstation 054233	Set of pincl punches with 6 tefon tips 052888	Infrared thermo-meter 052994	Heat Gun 066311	Levelling bar 050693	6 Gripping multihook head 049734	3 Lifting rods: 150, 300 & 500 mm 050792	Set of 3 conical plastic multipads 048096 048072 048089 048119 048102	Inertia hammer 057906	Set of 6 glue tips 050952	Glue Puller PRO 058699	Glue Puller PRO Export 059160	33PC Paintless dent repair kit 051959	PDR Light ultra light carbon X40PW 053175	Mini puller 050921	Aluminium clamp 2 050945
--------------------	---	------------------------------	-----------------	----------------------	----------------------------------	--	---	-----------------------	---------------------------	------------------------	-------------------------------	---------------------------------------	---	--------------------	--------------------------

GYSMART GLUE PULLING KIT 076051							✓								
GYSMART GLUE PULLING KIT EXPORT 076105						✓									✓
GYSMART GLUE PULLING KIT PLUS 076082							✓								✓
GYSMART GLUE PULLING KIT PLUS EXPORT 076129							✓								✓

## GLUE PULLER PRO (Steel/Alu • Acier/Alu)



## OPTIONS



## PDR TECH KIT

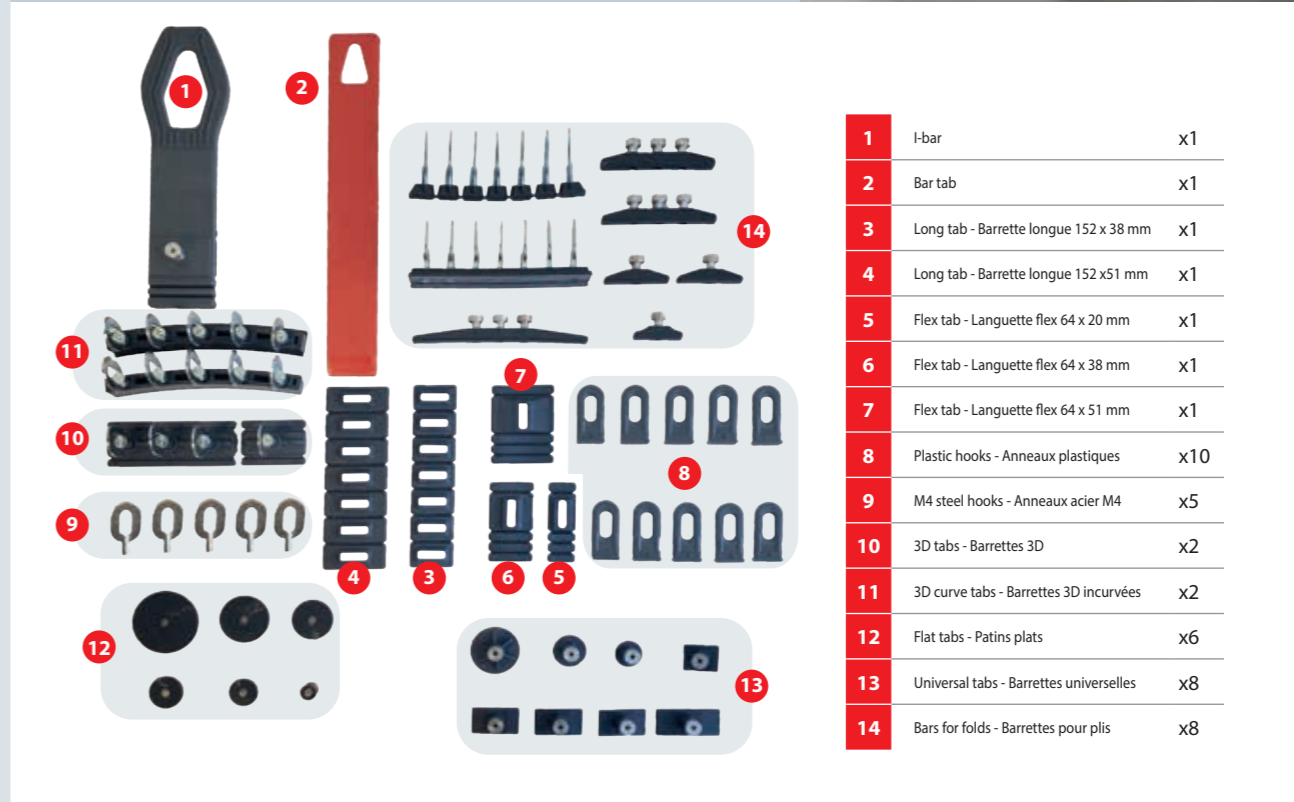

1	I-bar	x1
2	Bar tab	x1
3	Long tab - Barrette longue 152 x 38 mm	x1
4	Long tab - Barrette longue 152 x 51 mm	x1
5	Flex tab - Languette flex 64 x 20 mm	x1
6	Flex tab - Languette flex 64 x 38 mm	x1
7	Flex tab - Languette flex 64 x 51 mm	x1
8	Plastic hooks - Anneaux plastiques	x10
9	M4 steel hooks - Anneaux acier M4	x5
10	3D tabs - Barrettes 3D	x2
11	3D curve tabs - Barrettes 3D incurvées	x2
12	Flat tabs - Patins plats	x6
13	Universal tabs - Barrettes universelles	x8
14	Bars for folds - Barrettes pour plis	x8

## Options

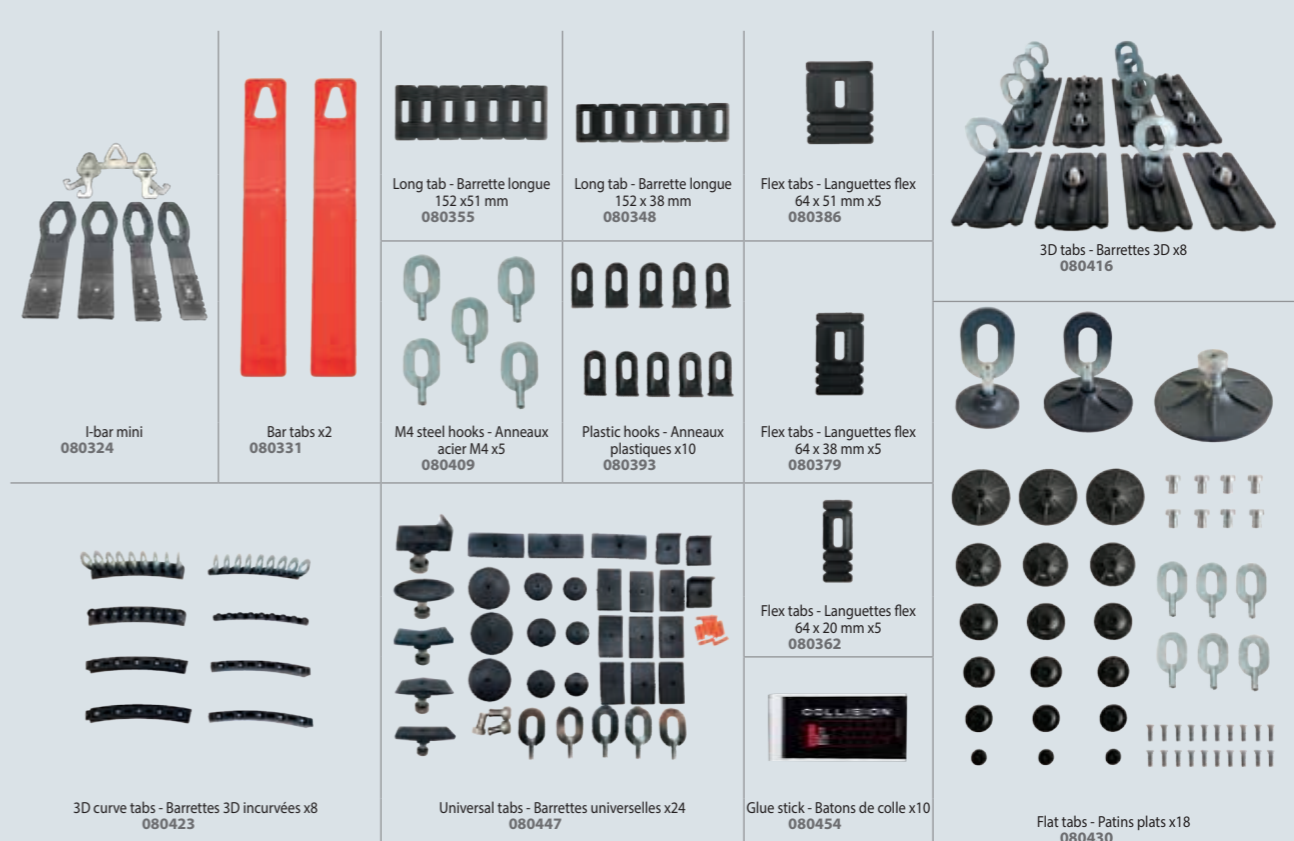



# TRUCK TOOLS & MOBILE LIFTS

## TRUCK TOOLS

TROLLEY IW1	51
MULTITOOL TRUCK	51

## CAR LIFTS

SPOT LIFT	52
ERGO LIFT / QUICK LIFT	54
AIR JACKS	55
MANUAL WHEEL LIFT	55



TROLLEY IW1 / MULTITOOL TRUCK

# TRUCK TOOLS

**TROLLEY IW1**  
Impact wrench trolley -  
Support de clé à choc

max 6.5 bar

max 20 kg

063136

### OPTIONS



Huile hydraulique  
- Hydraulic oil  
1l  
053397



Youtube

Weight, vibrations  
& torque suppression -  
Suppression du poids,  
des vibrations et du couple



42°

70 kg  
95 cm  
86 cm  
86 cm  
39 cm  
75 kg  
123 cm  
79 cm

Impact wrench -  
Clé à choc  
max 20 kg

Fixation  
36 x 36 mm  
→ 44 x 44 mm

90 cm (max)  
30 cm (min)

Weight adjust  
- Effort réglable

High dexterity -  
Liberté de mouvement

High maneuverability & stability -  
Grande maniabilité et stabilité



INVEST IN THE FUTURE

## MULTITOOL TRUCK **NEW**

SAFE EN 14238 + A1

max 200 kg

067158

### INCLUDED



Lifting tool for brake caliper  
- Outil de levage pour étrier  
de frein - Hebewerkzeug für  
Bremssattel



Brake caliper



Lifting tool for battery -  
Outil de levage pour batterie  
- Hebewerkzeug für Batterie



Truck batteries



Lifting tool for wheels -  
Outil de levage pour roues  
- Hebewerkzeug für Räder



SAFE  
EN 14238 + A1

ULTRA COMPACT  
103 cm

90°

90kg  
103 > 186 cm  
88.5 > 110 cm  
101 > 130 cm  
39 cm  
95 kg  
123 cm  
79 cm

HEALTH CARE



# SPOT LIFT

## MOBILE LIFTS

### SPOT LIFT EASY

max Air 8 bar **SAFE EN 1494**  
**max 2.2 t**

#### HEALTH CARE

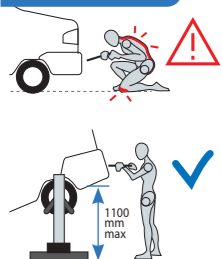

#### High stability - Haute stabilité

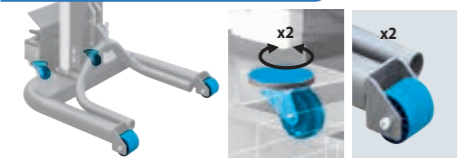

Included  
220 bar  
053588

**SAFE EN 1494**

#### SECURITY

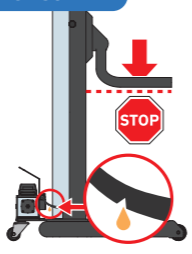

#### OPTIONS

Hydraulic oil 1L  
- Huile hydraulique  
1L  
053397

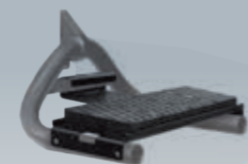

Rocker panel lifting tool  
- Outil de levage pour bas de caisse  
- Auflage für Seitenschweller  
053236



84 kg 1.27 m  
0.89m 0.76m

0.29m 93 kg  
1.23 m 0.79m



### SPOT LIFT PRO

max Air 8 bar **SAFE EN 1494**  
**max 2.2 t**

053557

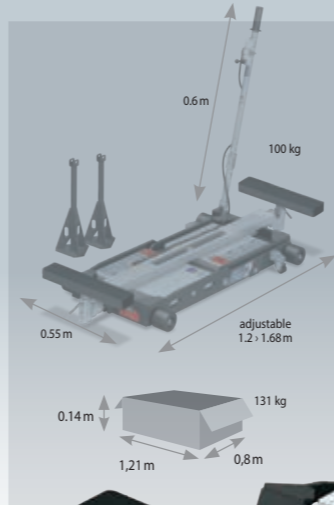

0.6m 100 kg  
0.55m adjustable 1.2 - 1.68m  
0.14m 131 kg  
1.21m 0.8m



### SPOT LIFT PRO MOB

max Air 8 bar **SAFE EN 1494**  
**max 2.2 t**

055896

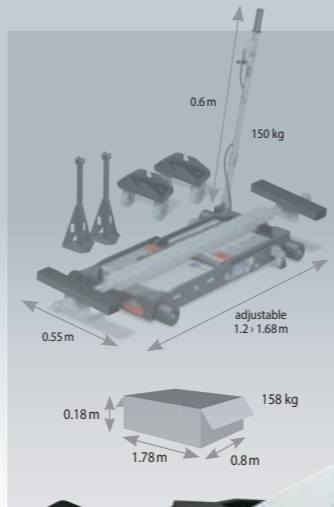

0.6m 150 kg  
0.55m adjustable 1.2 - 1.68m  
0.18m 158 kg  
1.78m 0.8m

**60 cm (max)**  
14 cm (min)

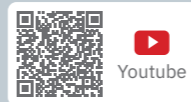

#### AUTO ROLL

min 500 mm  
max 1700 mm (AUTOROLL 1.0m)  
max 2240 mm (AUTOROLL 1.55m)  
**2.5 t max**

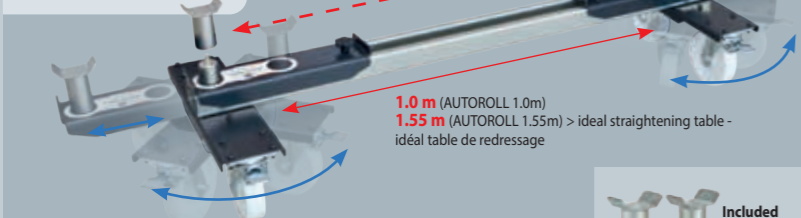

1.0 m (AUTOROLL 1.0m)  
1.55 m (AUTOROLL 1.55m) > ideal straightening table - idéal table de redressement

**AUTO ROLL 1.0 m / 1.2 t**  
059047



**AUTO ROLL 1.55 m / 1.2 t**  
063839



#### AFTER LIFT AUTO ROLL

1 2  
**2.5 t max**

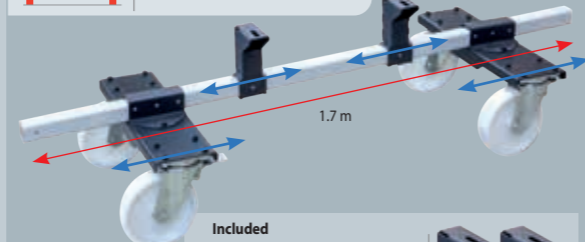

067967

45 Kg

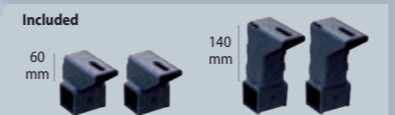

#### WHEEL TROLLEYS - Tabourets de manutention - Radhocker

048768

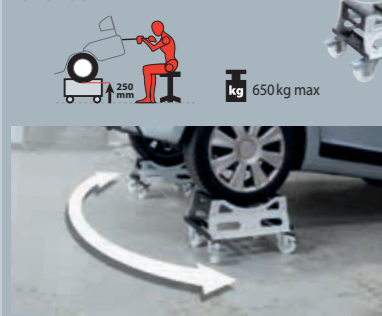

250 mm  
kg 650kg max

#### WHEEL TRUCKS - Chariots de manutention prise sous roue - Kfz-Montagelift, fahrbar

Chariots mécaniques (x 2)  
- Mechanic jacks (x2)  
071995

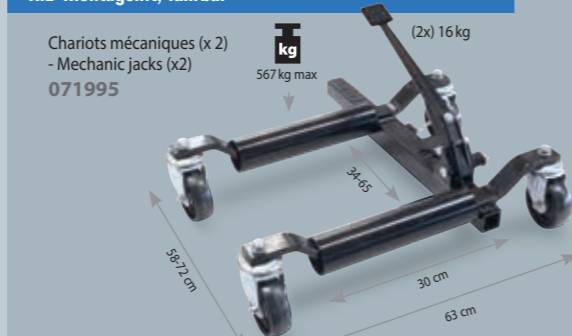

567 kg max (2x) 16 kg



Made in China

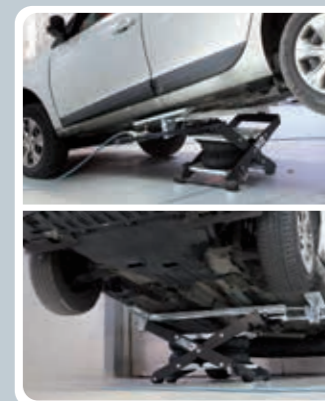

#### OPTIONS

Height adjuster for 4x4 & utility vehicles  
- Réhausseur pour 4x4 et utilitaires  
- Erhöhung f. 4x4 und Leicht-LKW



**Pads - Patins**  
for Audi & BMW  
(x 2)  
053717

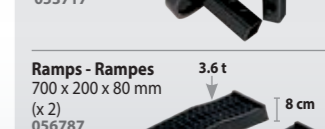

**Ramps - Ramps**  
700 x 200 x 80 mm  
(x 2)  
056787



#### OPTIONS

**SPOT LIFT PRO MOB**  
Réhausseur pour 4x4 et utilitaires  
- Height adjuster for 4x4 & utility vehicles  
- Erhöhung f. 4x4 und Leicht-LKW



**Patins - Pads**  
for Audi & BMW  
(x 2)  
061606

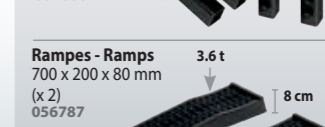

**Ramps - Ramps**  
700 x 200 x 80 mm  
(x 2)  
056787



## ERGO LIFT 650

220 V, 1~ **SAFE EN 1493**

**max 2 t**

056817



Youtube

220 V, 1 ph  
0.75 kW

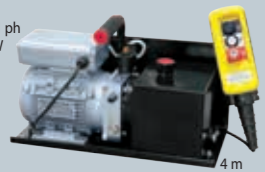

Included  
Hydraulic oil 5 L  
- Huile hydraulique  
5 L  
062160



### EASY 360° - Déplacements sur 360°



Removable wheels

### High stability - Haute stabilité

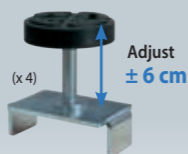

Adjust  
± 6 cm

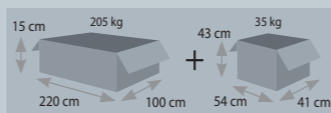

**SAFE EN 1493**



10 cm (min)

light weight - 200 kg

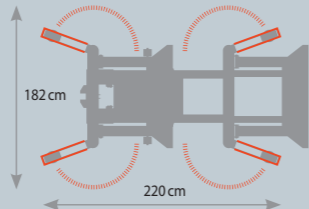

### Pack ERGO LIFT 650 + 4 Wheel trolleys (x4)

068544



## ERGO LIFT 1000 ROLL

Air 7-8 bars **SAFE EN 1493**

**max 2.5 t**

076792

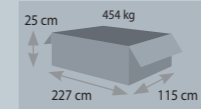

### High stability - Haute stabilité



**SAFE EN 1493**



**PATENT PENDING**

Handle for adjusting the automatic locking support arms  
Poignée de positionnement des bras porteurs avec verrouillage automatique

### Pack ERGO LIFT 1000 ROLL + wheels

076792



ERGO LIFT 1000 ROLL 067950

Wheel kit 076778

### ERGO LIFT 1000 ROLL

067950



10 cm (min)

382 kg

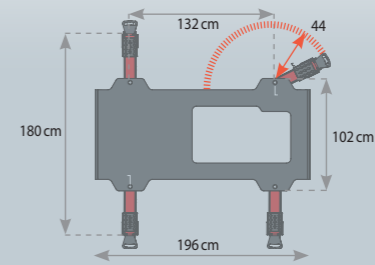

## QUICK LIFT L520E

062184

220 V, 1 ph  
0.75 kW

Included  
Hydraulic oil 5 L  
- Huile hydraulique  
5 L  
062160



Youtube

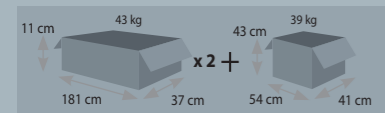

Made in China

46 cm (max)



**SAFE EN 1493**

**2.5 t max**

### OPTIONS

x4 Patins à rainures  
071933

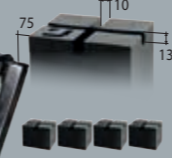

Pads for SUV - Patins pour SUV  
x4  
065017



Wall mount - Support mural  
071926



## AIR JACKS



**AIR JACK VAN 2T**  
058330

**2T max**

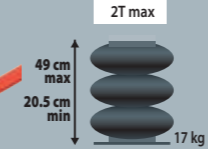

**AIR JACK CAR 2T**  
058323

**2T max**

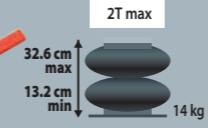

## MANUAL WHEEL LIFT

**Wheel lift trolley - Lève roue à treuil - Radmontage-Heber**  
061385

min: R13 / 135 / 65  
max: R22 / 300 / 35  
kg 40kg max

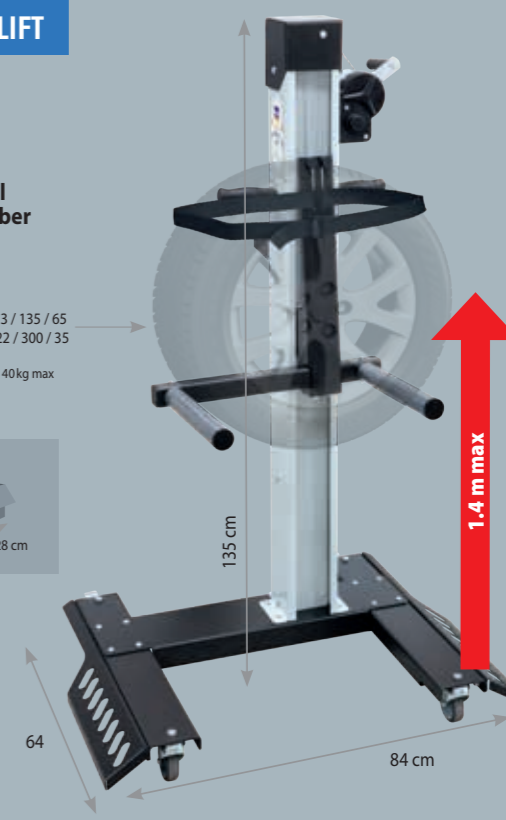
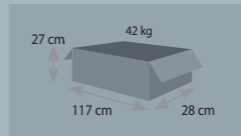

1.4 m max



# SPOT WELDING

TECHNOLOGY 58

GVSPOT 32D-X & 100R-CX 61

GVSPOT BP-LX & BP-LC-S7 62

PTI-S7 63

X & C ARMS 64

BP GENIUS 66

PTI PREMIUM PRO 68

PTI GENIUS 70

G ARMS 72

ACCESSORIES & CONSUMABLES 73

# ÉVOLUTION TECHNOLOGIQUE

TECHNICAL IMPROVEMENTS - TECHNISCHE ENTWICKLUNG - MEJORAS TECNICAS

**France**  
Facteurs d'évolution :  
• Challenge CO2 = faible poids  
• Crash test = ★★★★★  
• Anti corrosion = nouveaux revêtements  
• Esthétique et visibilité plus sophistiquées.

**UK**  
Evolution factors :  
• CO2 Challenge = low weight  
• Crash test = ★★★★★  
• Anti-corrosion = new coatings  
• Improved aesthetics and demand for better occupant visibility.

**Germany**  
Entwicklungsfaktoren :  
• CO2 Challenge = geringes Gewicht  
• Crash-Test = ★★★★★  
• Anti-Korrosion = neue Beschichtung  
• Modernes Technik-Design.

**Italy**  
Fattori di evoluzione :  
• Sfida CO2 = basso peso  
• Crash test = ★★★★★  
• Nuovi rivestimenti = anticorrosivi  
• Estetica e visibilità più sofisticate

2004

OLD SOLUTIONS

Traditional machines  
180 daN max  
6500 A max  
X clamps  
Ø 4 mm max

2023

GYS SOLUTIONS

INVERTER Technology  
550 daN max  
14500 A max  
X & C clamps  
Liquid cooled system  
Ø 10 mm

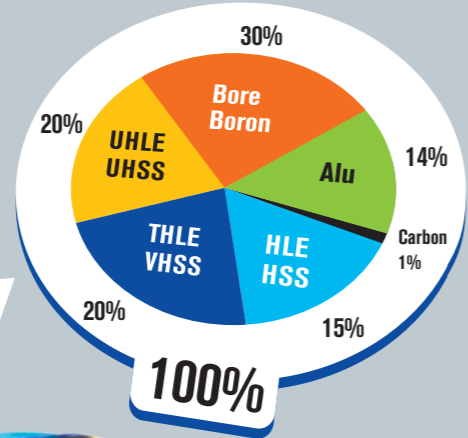
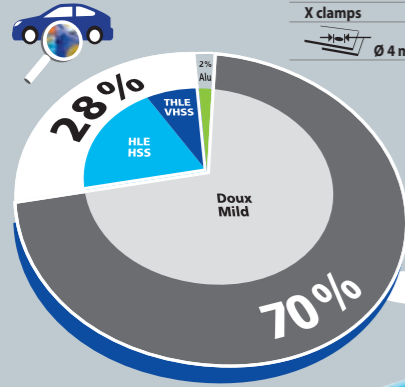

- HSS - HLE
- VHSS - THLE
- UHSS - UHLE
- Bore - Boron
- Aluminium

An example of new generation car body  
• Exemple de carrosserie nouvelle génération  
• Beispiel einer Karosserie der neuen Generation  
• Esempio di carrozzeria di nuova generazione

## HOMOLOGATIONS PRODUITS

MANUFACTURER APPROVALS / COMPLIANCE - PRODUKT HOMOLOGATIONEN - PRODOTTI APPROVATI



Product Category	Model	VW	Jeep	Mercedes	Smart	Dacia	Nissan	GM	Tata	Eicher	Kia	Jaguar	Land Rover	Ford	Honda	Volvo	Lynxco	BYD
DENT PULLER	GYSPT 2600/2700	•	•	•	•	•	•	•	•	•	•	•	•	•	•	•	•	•
	GYSPT 36-39.02/04, PRO230/400, EXPERT 200/230/400	•	•	•	•	•	•	•	•	•	•	•	•	•	•	•	•	•
	Workstations	•	•	•	•	•	•	•	•	•	•	•	•	•	•	•	•	•
	GYSPT ALU FV	•	•	•	•	•	•	•	•	•	•	•	•	•	•	•	•	•
RESISTANCE SPOT WELDER	GYSPT ARCPULL 200	•	•	•	•	•	•	•	•	•	•	•	•	•	•	•	•	•
	GYSPT 100R	•	•	•	•	•	•	•	•	•	•	•	•	•	•	•	•	•
	GYSPT BP-LX	•	•	•	•	•	•	•	•	•	•	•	•	•	•	•	•	•
	GYSPT BP-LC-s7	•	•	•	•	•	•	•	•	•	•	•	•	•	•	•	•	•
	GYSPT BP GENIUS	•	•	•	•	•	•	•	•	•	•	•	•	•	•	•	•	•
	GYSPT PTI-s7	•	•	•	•	•	•	•	•	•	•	•	•	•	•	•	•	•
	GYSPT PTI PREMIUM PRO	•	•	•	•	•	•	•	•	•	•	•	•	•	•	•	•	•
	GYSPT PTI GENIUS	•	•	•	•	•	•	•	•	•	•	•	•	•	•	•	•	•
VAS 821 101 - Spot Welder	•	•	•	•	•	•	•	•	•	•	•	•	•	•	•	•	•	
RIVE / MIG	GYS PRESS	•	•	•	•	•	•	•	•	•	•	•	•	•	•	•	•	•
	CARMIG	•	•	•	•	•	•	•	•	•	•	•	•	•	•	•	•	•
MIG / MAG	E1 GYS AUTO	•	•	•	•	•	•	•	•	•	•	•	•	•	•	•	•	•
	E2 E3 GYS AUTO	•	•	•	•	•	•	•	•	•	•	•	•	•	•	•	•	•
	AUTOPULSE 220-M1	•	•	•	•	•	•	•	•	•	•	•	•	•	•	•	•	•
	AUTOPULSE 220-M3	•	•	•	•	•	•	•	•	•	•	•	•	•	•	•	•	•
	AUTOPULSE 320-T1	•	•	•	•	•	•	•	•	•	•	•	•	•	•	•	•	•
	AUTOPULSE 320-T3	•	•	•	•	•	•	•	•	•	•	•	•	•	•	•	•	•
PLASMA	VAS 821 005 - Pulse MIG	•	•	•	•	•	•	•	•	•	•	•	•	•	•	•	•	•
	VAS 821 00580 023	•	•	•	•	•	•	•	•	•	•	•	•	•	•	•	•	•
	EASYCUT 40	•	•	•	•	•	•	•	•	•	•	•	•	•	•	•	•	•
CUTTER	CUTTER 25K/35KF	•	•	•	•	•	•	•	•	•	•	•	•	•	•	•	•	•
	CUTTER 30FV/45CT	•	•	•	•	•	•	•	•	•	•	•	•	•	•	•	•	•
GYS DUCTION AUTO	•	•	•	•	•	•	•	•	•	•	•	•	•	•	•	•	•	

## RANGE

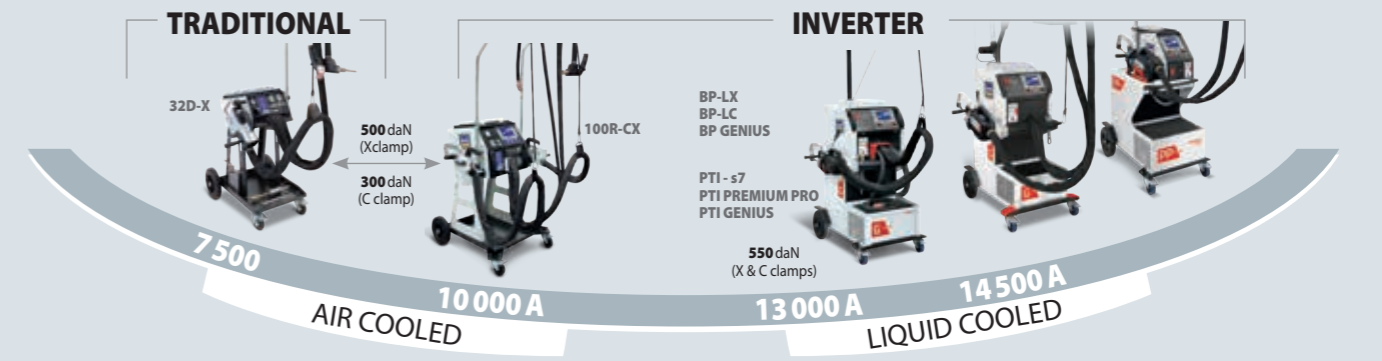

Model	32 D	100 R	BP / BP GENIUS	PTI-s7	PTI PREMIUM PRO	PTI GENIUS
-------	------	-------	----------------	--------	-----------------	------------

Mild - Doux	•	•	•	•	•	•
HSS/VHSS - HLE/THLE → ⚠	X	•	•	•	•	•
UHSS/BORON - UHLE/BORE	X	Difficult	•	•	•	•

Number of spots - Nombre de points 10 spots/min	0.8 + 0.8 mm	100	150	no limit	no limit
	2.5 + 2.5 mm	5	10	95	60

Inverter Technology	—	•	•	•	•
EMF Directive 2013/35/UE (⚡)	—	—	BODY PROTECT TECHNOLOGY	•	•
Cooling system - Système de refroidissement	AIR ❄️	AIR ❄️	LIQUID ❄️	LIQUID ❄️	LIQUID ❄️
Automated regulation - Régulation automatique	I (A)	—	•	•	•
	daN	—	•	•	•
	Ø	irregular	constant	constant	constant

MODE AUTO	—	—	• (LC, LG)	•	
Pince - Clamp	X	• (32DX)	• (BPLX)	—	
	C	—	• (BPLC, BPLG)	• G clamp	
	X+C	—	• (100R-CX)	—	
Transformer Inside Clamp	—	—	—	•	
Cables (L)	2.5 m	2.5 m	2.5 m	4 or 6 m	6 m
Includes gun	•	•	•	option	option

Max welding frequency (spots/min) - Cadence de soudage maximale (points/min)	0.8 + 0.8 mm	10	10	BP-LC : 10 - BP-LG : 20			10	20		
	2.5 + 2.5 mm	6	2	6	10	2	6	10	10	20
Fuse	400 V	32 A	32 A	40 A	50 A	32 A	40 A	50 A	20 A	25 A
	200/208-240 V	—	—	—	—	60 A	80 A	100 A	40 A	50 A



# SPOT WELDING

PORTASPOT 230

**6 300 A** 120 daN

Air cooled

230V  
022256

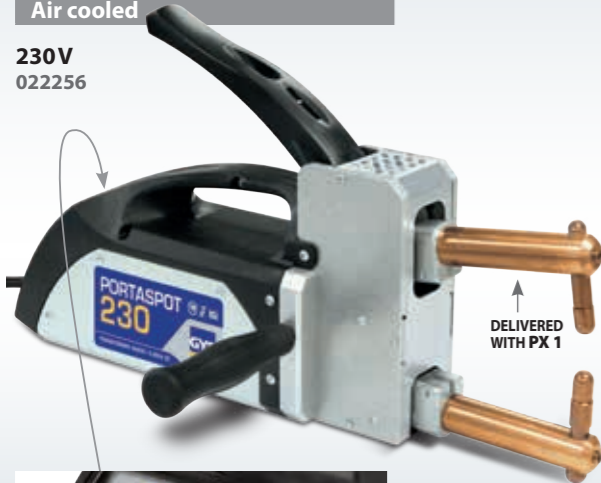

DELIVERED WITH PX 1



ARMS Ø 23 mm

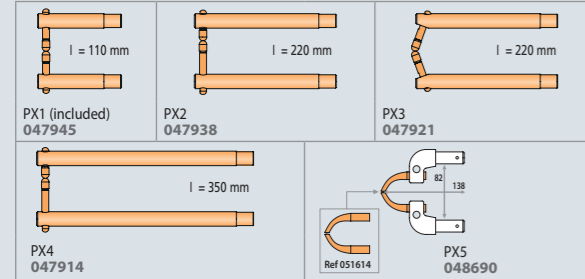

ELECTRODES

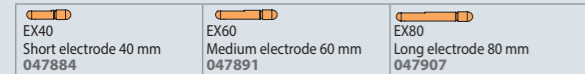

CAPS & ACCESSORIES

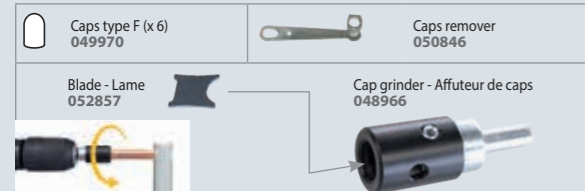

50/60 Hz	A	A	A	mm	V	m	mm <sup>2</sup>	100% CU	LxWxH cm / kg
1 x 230V	<b>16(D)</b>	<b>6 300</b>	8 900	2+2	2.45	2.5	3x2.5 H05VVf	OK	41 x 18 x 22 / 11.3

GYSPOT 32D-X

**7 500 A** 500 daN

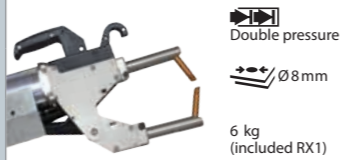

Air cooled

2 x 400V  
019881



	included
Monopoint/Spot 049291	▪
Inertia hammer 049482 + 049802	▪
Spotter box pro 050075	▪
Top support box	▪
Contact grease 050440	▪
Caps remover 050846	▪
Cable support	▪
RX1 051034	▪
RX2 051041	▪

GYSPOT 100R-CX

**10 000 A** 500 daN (X)  
300 daN (C)

For mild steel, HSS, UHSS

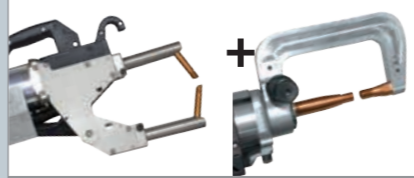

Air cooled

Traceability software  
Save spot welding configuration and export data

3 x 400V  
022317

	included
Monopoint/Spot 049291	▪
Inertia hammer 049482 + 049802	▪
Spotter box pro 050075	▪
Top support box	▪
Contact grease 050440	▪
Caps remover 050846	▪
Cable support	× 2
RX1 051034	▪
RX3 051058	▪
RC1 051065	▪
RC2 051072	▪
RC3 051089	▪



OPTION 100R-CX

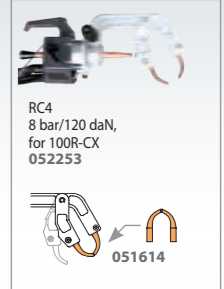

OPTIONS



MADE IN FRANCE CE NORM. 62135	50/60 Hz	A	Spots/min (max)	RMS	MAX	mm	Uo	Cables			100% CU	LxWxH cm / kg
								Air Cooled	Ø mm	mm <sup>2</sup>		
GYSPOT 32D.X	400V	32 (13 kVA)	6	7 500	10 500	3 + 3	1,2 + 3	2,2	200	OK	79 x 57 x 54 / 111	
								2,5	150			
								8	3 x 6 HO7RNF			
GYSPOT 100R.CX	3 x 400V	40 (28 kVA) 50 (35 kVA)	2 6 10	10 000	—	2.5+2.5+2.5	1,5 + 3	2,5	200	OK	61 x 79 x 71 / 137	
								2,5	150			
								8	4 x 6 HO7RNF			

**GYSPOT BP-LX**  
**13 000 A**  
550 daN

For mild steel, HSS, UHSS **Boron steel**

Double pressure  
Ø 10 mm  
6.5 kg (included X1)

**Liquid cooled**

**BP BODYPROTECT**  
Unique electro-magnetic field protection  
2013/35/UE by GYS

**Traceability software**  
Save spot welding configuration and export data

019652

	019652	058804
<b>400V</b>		
Gyspot BP-LX	▪	▪
Monopoint/Spot 049291	▪	▪
Spotter box pro (p.10) 050075	▪	▪
Inertia hammer 049482 + 049802	▪	▪
X1 050501	▪	▪
X4A (x2) + X4B + X4C + X2 020733	▪	▪
Liquid cooling (10L) 052246		(x3)

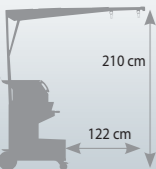

**OPTIONS**

050068  
x10 (x20: 052239)  
x6 (x6: 049994)

x18 (x6: 049987)  
x18 (x6: 049970)

**NEW** Caps type A box 048935  
Caps type F box 077119

SD CARD 050914

Cooling liquid - Liquide de refroidissement - Kühlmittel - Enfriamiento líquido - Refrigeração líquida  
10L

Protection cover - Housse de protection - Schutzhäube  
for BP & PTI  
050853

Included High stability support - Support haute stabilité gyro +

**GYSPOT BP-LC-s7**  
**13 000 A**  
550 daN

For mild steel, HSS, UHSS **Boron steel**

Double pressure  
Ø 10 mm  
6.5 kg (included C1)

**Liquid cooled**

**BP BODYPROTECT**  
Unique electro-magnetic field protection by GYS

**Traceability software**  
Save spot welding configuration and export data

020757

	020757	058798
<b>400V</b>		
Gyspot BP-LC-s7	▪	▪
Monopoint/Spot 049291	▪	▪
Spotter box pro (p.10) 050075	▪	▪
Inertia hammer 049482 + 049802	▪	▪
Contact grease 050440	▪	▪
Caps remover 050846	▪	▪
Arm panel	▪	▪
C1 019140	▪	▪
C2 + C3 + C4 060821	▪	▪
C6 022409	▪	▪
Liquid cooling (10L) 052246		(x3)



Mandrels for gun - Mandrins pour pistolets - Pistole & Anschlußstücke, Zubehör

**OPTIONS BP-LC**

S1 < nov 2010 048171

S2 > nov 2010 048188

GYRO 360° for BP-LC 051737

10-14 kg

**GYSPOT PTI-s7**  
**14 500 A**  
550 daN

For mild steel, HSS, UHSS **Boron steel**

FUSE 20 A  
Double pressure  
Ø 10 mm  
9.9 kg (included C1)

**TRANSFORMER INSIDE**

**Liquid cooled**

**Traceability software**  
Save spot welding configuration and export data

020894

	4M 020894	4M 067998
<b>220V</b>	6M 022195	6M 020900
<b>400V</b>		
Gyspot PTI-s7	▪	▪
Contact grease 050440	▪	▪
Caps remover 050846	▪	▪
Arm panel	▪	▪
C1 021402	▪	▪
C2 + C3 + C4 060821	▪	▪
C6 022409	▪	▪
Gyro 360° 051720	▪	▪
Complete gun kit 067318	▪	▪
Liquid cooling (10L) 052246		(x3)

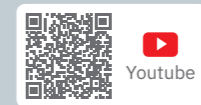
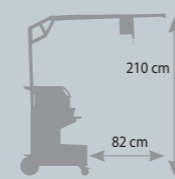

**Very light**  
9.9 kg

10-14 kg 059696

**CONVERT PTI S-7 > PTI PREMIUM PRO WITH G ARMS**

**KIT RENOV PTI PREMIUM PRO 220V 072367**

400V 072541

**C ARMS** → **G ARMS**

**OPTION**

200 mm<sup>2</sup> 1.6 m

300 mm<sup>2</sup> 1m

Complete gun kit 067318

GYRO 360° for PTI 051720

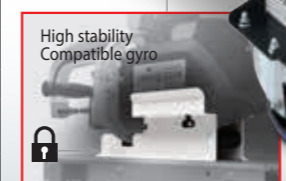

MADE IN FRANCE 62135	50/60 Hz	A D curve	Spots/min (max) 2.5+2.5	RMS A	Uo V	mm			Cables			100% CU	cm	kg
						2.5+2.5+2.5	1.5+3	2.5, liquid	2.5	8m, 4x6 HD78NF	OK			
<b>GYSPOT BPLX</b>	3 x 400V	32 (22 kVA) 40 (28 kVA) 50 (35 kVA)	2 6 10	13 000	16	2.5+2.5+2.5	1.5+3	2.5, liquid	2.5	8m, 4x6 HD78NF	OK	65 x 80 x 205	164.5	
<b>GYSPOT BPLC-s7</b>														
<b>GYSPOT PTI-s7</b>	3 x 400V	20 (14 kVA)	10	14 500	7.3	2.5+2.5+2.5	1.5+3	4m, liquid	6m, liquid	8m, 4x4 HD78NF	OK	65 x 80 x 230	105.3	
<b>GYSPOT PTI-s7 220 V</b>														
	3 x	200 208 220 240	10	12 500 13 000 14 500 14 500	6.5 6.7 7.4 7.7	2.5+2.5+2.5	1.5+3	4m, liquid	6m, liquid	8m, 4xAWG8 (SOOW)	OK	65 x 80 x 230	115.7	



FOR GYSPOT 32D-X, 100R-CX, BP-LX

550 daN

6,5 kg including X1

- DOUBLE PRESSURE
- LIQUID COOLED REFRIGERATION LIQUIDE
- Ø 10 mm



MADE IN FRANCE

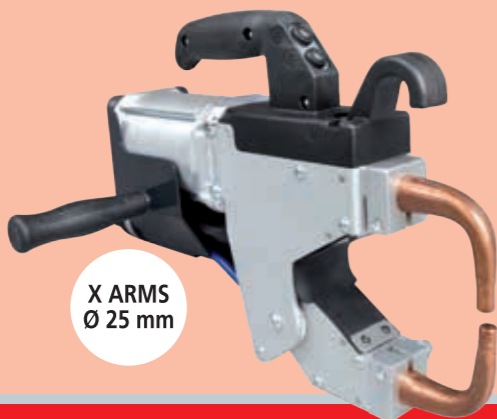

X ARMS Ø 25 mm

X Arms - Caps Ø13 mm

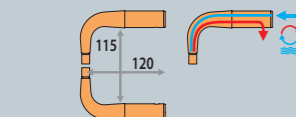

X1 8 bar/550 daN

050501

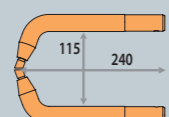

X2 8 bar/400 daN

050518

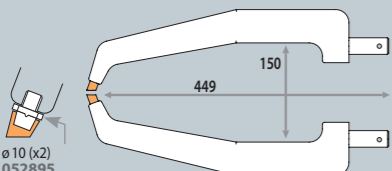

X4 8 bar/120 daN

050532

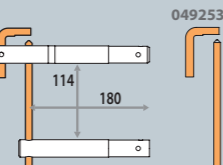

X5 8 bar/200 daN

050549

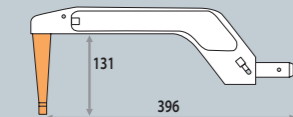

X4A 8 bar/150 daN

020702



X4B 8 bar/150 daN

020719

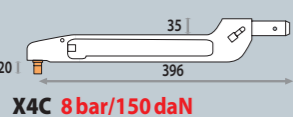

X4C 8 bar/150 daN

020726

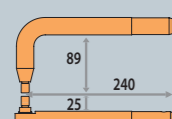

X6 8 bar/400 daN

050587

X4 (A, B & C) combinations



X4A + X4A



X4A + X4B



X4B + X4B



X4A + X4C



X4C + X4C



X4B + X4C

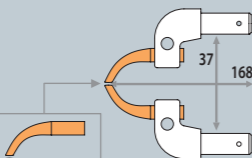

X11 3 bar/150 daN

051607

X ARMS PANELS

X4A (x2) + X5 + X2

022324

X4A (x2) + X4B + X4C + X2

020733

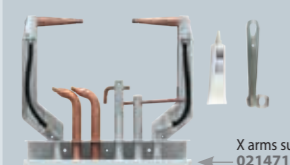

X arms support 021471

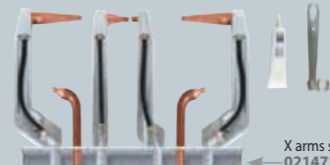

X arms support 021471

Remote control (BP)



Digital screen control Change Mode & Parameters

X clamp control



C clamp control



C ARMS PANELS



C2 + C3 + C4

060821



C2 + C3 + C6 + C12 + C9

= 061316

2 BOXES



C10 + C3 + C5 + C6 + C9

= 076495

NEW



FOR GYSPOT BP-LC, PTI

550 daN

6,5 kg including C1

- DOUBLE PRESSURE
- LIQUID COOLED REFRIGERATION LIQUIDE
- Ø 10 mm



MADE IN FRANCE



550 daN

Transformer inside

9,9 kg including C1

DOUBLE PRESSURE

- AIR COOLED + LIQUID COOLED
- DOUBLE REFRIGERATION AIR + LIQUID

Ø 10 mm

C Arms - Caps Ø13 mm

Classic arms



CLASSIC FINISH

Bras isolés - Isolated arms - Isolierte Bügel



ELECTRICAL INSULATION

PTI arm support kit 077577



BP arm support kit 080089

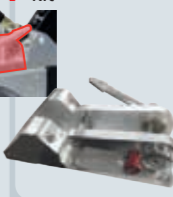

Arm lock pin 062405

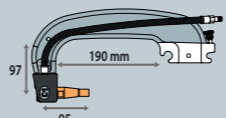

C1 8 bar/550 daN

021402

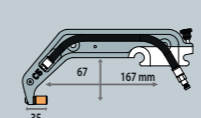

C5 8 bar/550 daN

022393

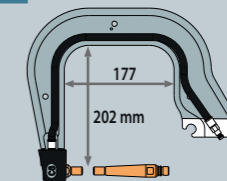

C8 8 bar/550 daN

021440

X Arms - Caps Ø13 mm

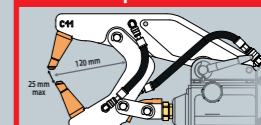

C11 8 bar/550 daN

053649

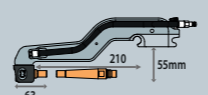

C2 8 bar/550 daN

022386

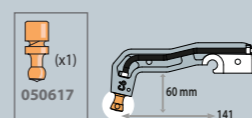

C6 8 bar/300 daN

022409

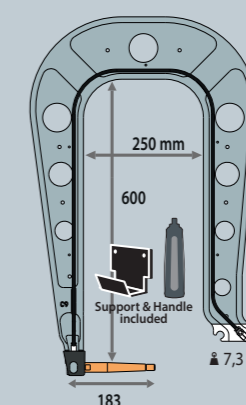

C9 8 bar/550 daN

020078

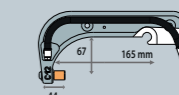

C12 8 bar/550 daN

022997

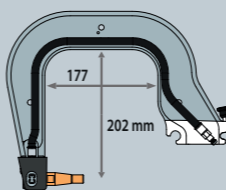

C3 8 bar/550 daN

021419

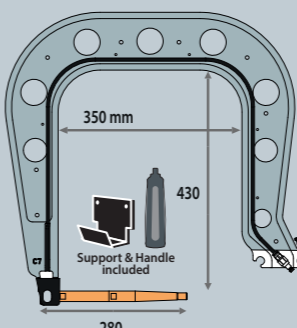

C7 8 bar/550 daN

021433

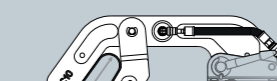

C10 4 bar/150 daN

051638

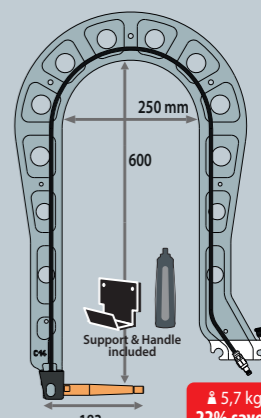

C14 8 bar/400 daN

023543

5,7 kg 22% saved

Option for C7

C7-SA (Small Access) 067684

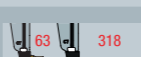

021426

Option for C9 & C14

C9/C14-SA (Small Access) 067660

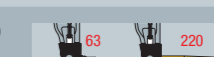

021426



GYSPOT

# SPOT WELDING BP

**G**  
ARMS

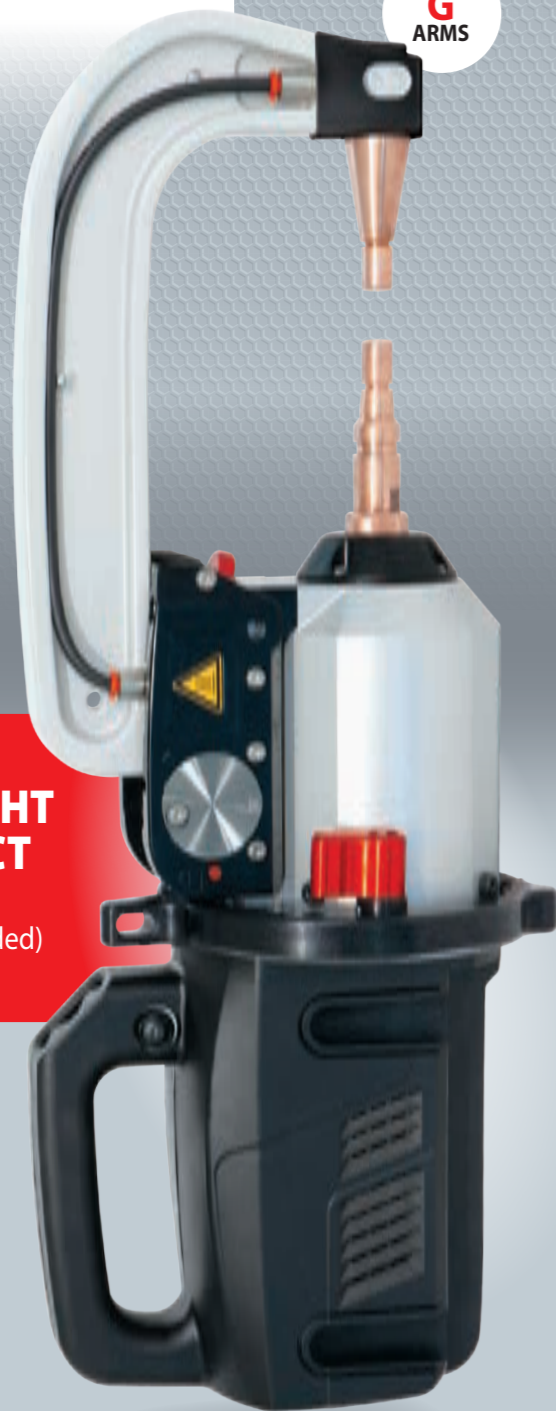

**ULTRA LIGHT & COMPACT**  
6.5 kg  
(Gyro & G1 included)

550 daN

LIQUID COOLED  
REFROIDISSEMENT  
LIQUIDE  
Ø 10 mm

6.5 kg  
(Gyro & G1 included)



Youtube

### OPTIONS

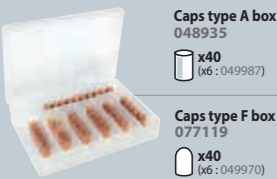

**Caps type A box**  
048935  
x40 (x6: 049987)  
x6 (x6: 049970)  
x2 (x1: 050617)  
073449



Cooling liquid  
- Liquide de refroidissement  
- Kühlmittel  
- Enfriamiento líquido  
- Refrigeração líquida  
052246



Protection cover  
- Houise de protection  
- Schutzhaube  
for BP & PTI  
050853



10L  
10-14 kg  
059696

### FAST OPEN XL

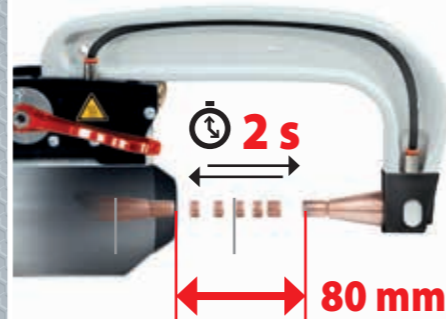

### EASY



### GYRO INTEGRATED



### PERFECT ELECTRICAL CONNECTION



### AUTO



## GYSPOT BP GENIUS

**13 000 A**  
550 daN

For mild steel, HSS, UHSS Boron steel

**BP** BODYPROTECT  
2013/ISS/UE Unique electro-magnetic field protection by GYS

Traceability software  
Save spot welding configuration and export data

023451



	023550	023451	023499
Gyspot BP GENIUS	220 V	400 V	
Monopoint/Spot 049291	▪	▪	▪
Spotter box pro (p.10) 050075	▪	▪	▪
Inertia hammer 049482 + 049802	▪	▪	▪
Caps remover 050846	▪	▪	▪
Arm support	▪	▪	▪
G1 022768	▪	▪	▪
G2 + G3 + G4 022896	▪	▪	▪
Liquid cooling (10L) 052246			(x3)



MADE IN FRANCE 62135	50/60 Hz	A D curve	Spots/min (max) 2.5+2.5	I <sub>RMS</sub> A	U <sub>o</sub> V	mm			Cables			100% CU	cm	kg
						2.5	1.5	3	2.5 m, Ø 200 mm <sup>2</sup> , Liquid	2.5 m, Ø 150 mm <sup>2</sup> air	8 m 4x16 mm <sup>2</sup> (6AWG) 500W			
GYSPOT BP GENIUS 220 V	3 x	200	2	10 500	15	2.5+2.5+2.5	1.5+3	2.5 m, Ø 200 mm <sup>2</sup> , Liquid	2.5 m, Ø 150 mm <sup>2</sup> air	8 m 4x16 mm <sup>2</sup> (6AWG) 500W	OK	65 x 80 x 205	178	
		208			15.5									
		220			17									
GYSPOT BP GENIUS 400V	3 x 400V	60 (21-25 kVA)	2	13 000	16	2.5+2.5+2.5	1.5+3	2.5 m, Ø 200 mm <sup>2</sup> , Liquid	2.5 m, Ø 150 mm <sup>2</sup> air	8 m 4x6 mm <sup>2</sup> H07RNF	OK	65 x 80 x 205	171	
		80 (28-33 kVA)												6
		100 (35-41 kVA)	10											



67

GYSPOT BP GENIUS

LIQUID COOLED

Gun & cable support

Included Protection 067271

Included Cable support for BPLG ULTRA RESISTANT 059719



GYS POT

# SPOT WELDING PREMIUM PRO



MADE IN FRANCE

**NEW**

**FULL  
ERGONOMIC**

10.3 kg  
(Gyro & G1 included)

550 daN



10.3 kg  
(Gyro & G1 included)

**Ergonomy & Security**

20°  
**EASY  
HANDLE**

**LOCKING  
SYSTEM**

**G  
ARMS**



**TRANSFORMER INSIDE**

**GYRO INCLUDED**



**PERFECT ELECTRICAL CONNECTION**

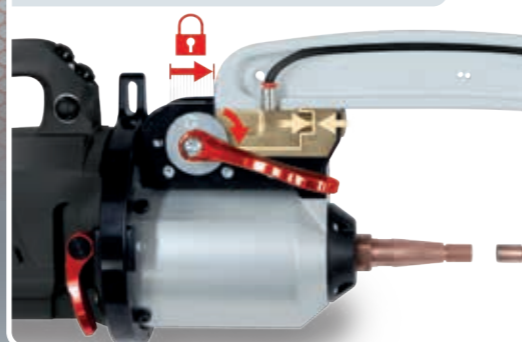

**AUTO**

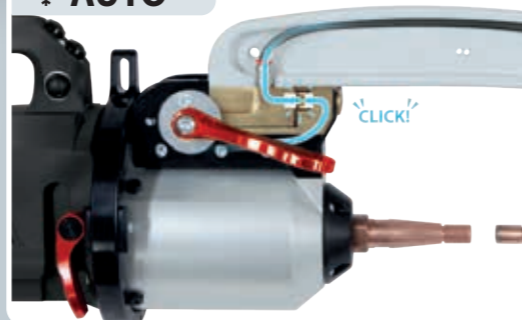

**XL Balancer**



**GYSPOT  
PTI PREMIUM PRO**

**14500 A**  
550 daN

For mild steel, HSS, UHSS



**TRANSFORMER INSIDE**

Liquid cooled

Traceability software  
Save spot welding configuration  
and export data

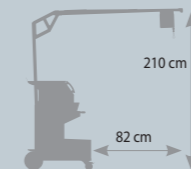

**NEW**



10.3 kg

	6M	
	072206	072183
	<b>220 V</b>	<b>400 V</b>
GYSPOT INVERTER PTI PREMIUM PRO		
Caps remover 050846		
Arm panel		
G1 022768		

**OPTIONS**

**G11**  
for PTI PREMIUM  
PRO only

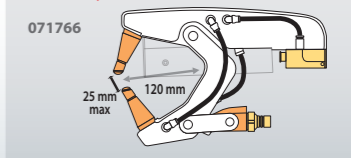

**OPTIONS**

	Caps type A box 048935	x40 (x6: 049987)			
	Caps type F box 077119	x40 (x6: 049970)			
	Cooling liquid - Liquide de refroidissement - Kühlmittel - Enfriamento líquido - Refrigeração líquida	10L			
	SD CARD 050914	2 GB			

MADE IN FRANCE	50/60 Hz	A D curve	Spots/min (max)	RMS A	Uo V	mm	Cables			100 % CU	cm	kg	
							↔	↔	↔				
<b>GYSPOT PTI PREMIUM PRO 220V</b>	3 x	200 208 220 240	10	12500 13000 14500 14500	6.6 6.9 7.3 7.9	2.5+2.5+2.5	1.5 + 3	6 m, liquid	OPTION 067226; 1.8 m, Ø 300 mm²	8 m, 4x4 H07RNF	OK	65 x 100 x 230	118.7
<b>GYSPOT PTI PREMIUM PRO 400V</b>	3 x 400V	25 (14 kVA)	10	14 500	7.3	2.5+2.5+2.5	1.5 + 3	6 m, liquid	OPTION 067226; 1.8 m, Ø 300 mm²	8 m, 4x4 H07RNF	OK	65 x 100 x 230	109.2



69

GYSPOT PTI PREMIUM PRO

LIQUID COOLED



GYSPOT

# SPOT WELDING GENIUS



MADE IN FRANCE

**G**  
ARMS

550 daN

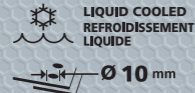

11.3 kg  
(Gyro & G1 included)

**TRANSFORMER  
INSIDE**

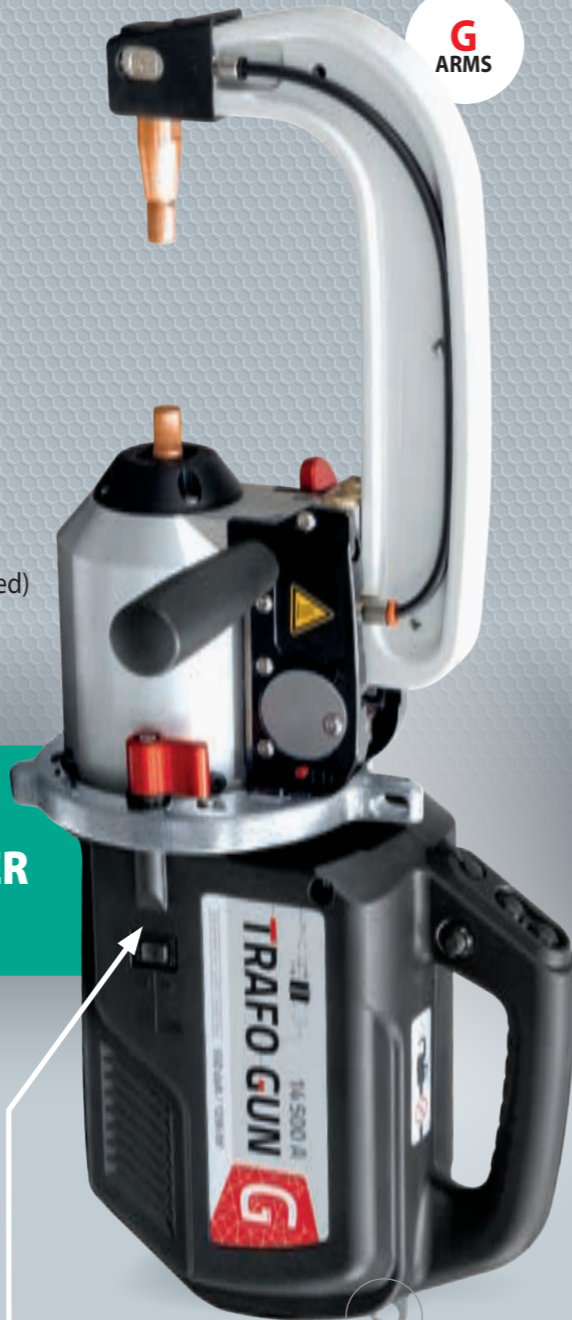

### FAST OPEN XL

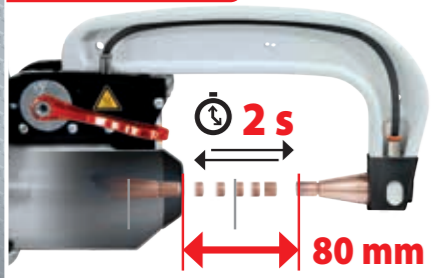

### GYRO INTEGRATED

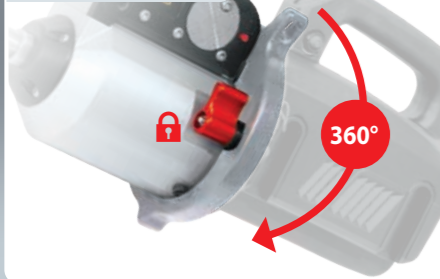

### PERFECT ELECTRICAL CONNECTION

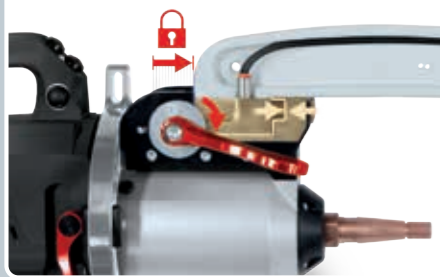

### AUTO

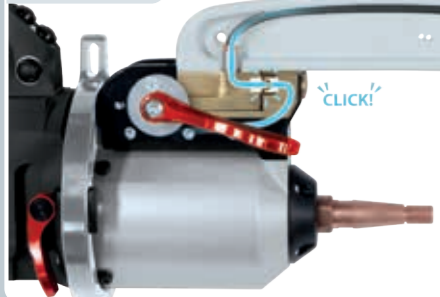

### OPTIONS

Caps type A box 048935 (x6: 049987)	SD CARD 050914	Kit WIFI Compatibility: Gyspot Inverter PTI-GENIUS 070691	Cooling liquid - Liquide de refroidissement - Kühlmittel - Enfriamiento liquido - Refrigeração líquida 052246	Protection cover - Houuse de protection - Schutzhaube for BP & PTI 050853 for PTI GENIUS 077126

## GYSPOT PTI GENIUS

**14 500 A**  
550 daN

For mild steel, HSS, UHSS    Boron steel

**TRANSFORMER INSIDE**

Liquid cooled

Traceability software  
Save spot welding configuration and  
export data

	024854	024878	068001	024892
	220V	400V	480V	
Gyspot PTI-GENIUS				
Caps remover 050846	■	■	■	■
Arm support	■	■	■	■
G1 022768				
G2 + G3 + G4 022898			■	
Kit gun 067226			■	
Liquid cooling (10L) 052246			(x3)	

### Ergonomic

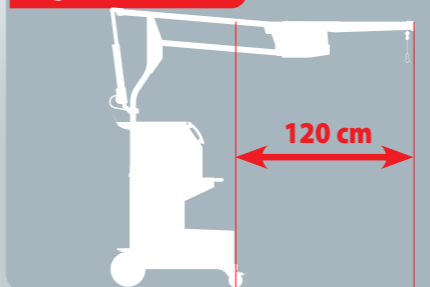

Included  
Cable support  
ULTRA  
RESISTANT



**ELECTRIC  
MOTOR**

Control  
Commande

Electrode storage  
- Rangement pour  
électrodes

6 m

### OPTIONS

Kit gun  
067226

300 mm<sup>2</sup>  
1.8 m

300 mm<sup>2</sup>  
1m

MADE IN FRANCE 62135	50/60 Hz	A D curve	Spots/min (max) 2.5+2.5	I RMS A	Uo V	mm		Cables		cm	kg	
						mm	mm	mm	mm			
GYSPOT PTI GENIUS 220 V	3 x	200 208 220 240	50 (17-21 kVA)	20	12 500	6.6	2.5+2.5+2.5	1.5+3	6 m, Liquid	8 m 4xAWG8 (500W)	71 x 90 x 200	136.2
					13 000	6.9						
					14 500	7.3						
GYSPOT PTI GENIUS 400V	3 x 400 V	25 (17 kVA)	20	14 500	7	2.5+2.5+2.5	1.5+3	6 m, Liquid	8 m 4x4 mm <sup>2</sup> H07RN6	71 x 90 x 200	185.5	
					7.9							
GYSPOT PTI GENIUS 480V	3 x 480 V	20 (17 kVA)	20	14 500	7	2.5+2.5+2.5	1.5+3	6 m, Liquid	8 m 4xAWG12 (500W)	71 x 90 x 200	128.7	

**FOR GYSPOT BP GENIUS, PTI PREMIUM PRO & PTI GENIUS**

G Arms - Caps Ø13 mm

Bras isolés - Isolated arms - Isolierte Bügel

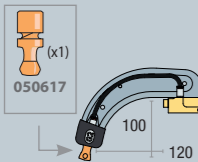

**G2**  
8 bar/300 daN  
022775

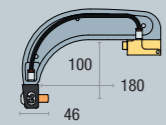

**G6**  
8 bar/550 daN  
022812

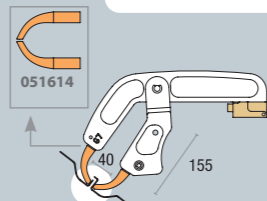

**G7**  
4 bar/150 daN  
022829

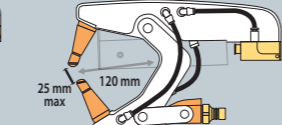

**G11**  
8 bar/550 daN  
for PTI PREMIUM PRO only  
071766

Kit de maintenance connecteurs pince G - Connectors maintenance kit for G clamp 067295

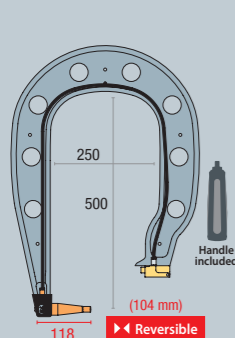

**G4**  
8 bar/550 daN  
022799

Option for G4

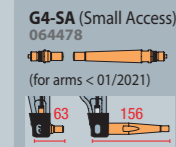

**G4-SA (Small Access)**  
064478  
(for arms < 01/2021)

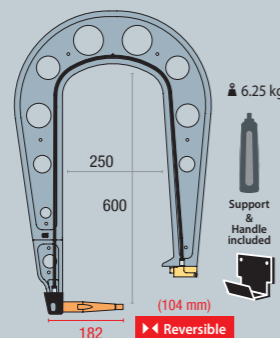

**G5**  
8 bar/550 daN  
022805

Option for G5

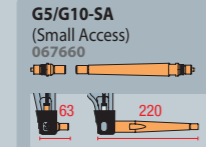

**G5/G10-SA (Small Access)**  
067660

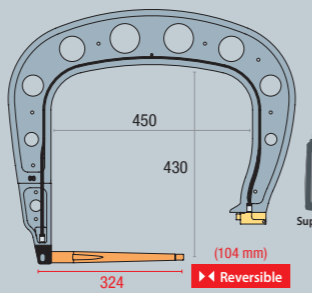

**G8**  
8 bar/550 daN  
022836

Option for G8

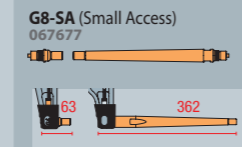

**G8-SA (Small Access)**  
067677

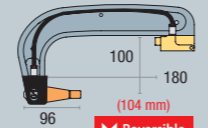

**G1**  
8 bar/550 daN  
022768

Option for G1 & G3

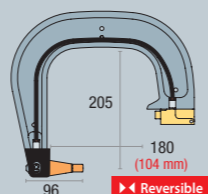

**G3**  
8 bar/550 daN  
022782

**G1/G3-SA (Small Access)**  
067653  
(for arms > 02/2021)

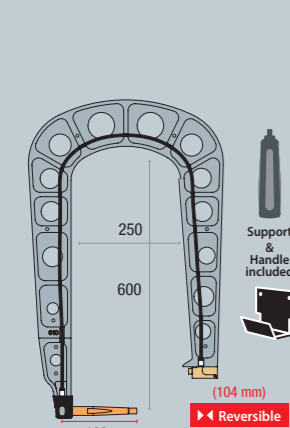

**G10**  
8 bar/400 daN  
067165

Option for G10 & G12



**G5/G10/G12-SA (Small Access)**  
067660

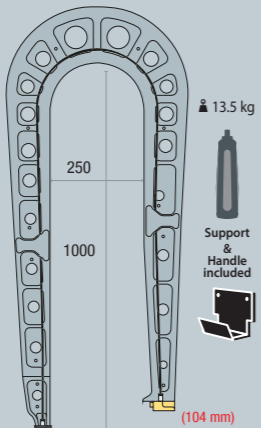

**G12**  
8 bar/300 daN  
075238



**G5/G10/G12-SA (Small Access)**  
067660

**G X** **AUTOMATIC WELDING FOR X1, X2 & X6**

**G9 | 8 bar/550 daN**  
not for PTI PREMIUM PRO

**G9 with X1 Included**  
022881

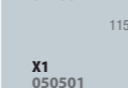

**G9 with X6 Included**  
072275

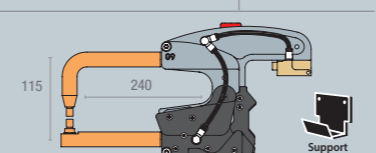
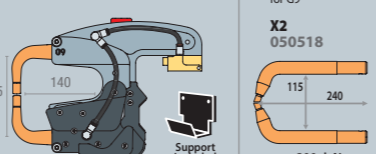
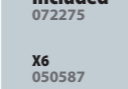

90284 + 55121  
for BP-G < Oct. 2019

Option SD card 050914  
Option PCB 97449C



**X/C/G CONSUMABLES - Consommables X/C/G**

Type A Cor X clamp Ø 13 mm (x6) 049987	Type D Cor X clamp Ø 13 mm (x10) 058507	TYPE G Ø 13 mm (x10) 059672	Caps type A box 048935 x40	073449 x20
Type B Cor X clamp Ø 13 mm / Ø 5 mm (x6) 055506	TYPE F For single sided gun Ø 13 mm (x6) 049970	Caps inclinés - Beveled X2, X4, C11 arms Ø 13 mm (x6) 049994	Caps type F box 077119 x40	x6 x2
Contact grease Graisse contact 050440	Caps remover 050846	Anti-corrosion welding primer - Primaire de soudage anti-corrosion 076822	Spot / Monopoint 049291	050068 x10 x6 x18 x18

**CAP GRINDER - Affuteur de caps**

Lame - Blade 052857

048966

Optimal speed: 400-800 rpm

Youtube

**GYRO 360°**

for BPLC/BPLCX 051737

10-14 kg

for PTI 051720

**STEEL SHEET TRACTION BENCH**

- Banc de traction arrache tôle - Blech-Zugbank zur Festigkeitsprüfung

052420

052321 (included)

**WELD TEST KIT - Valise test soudure HLE / THLE**

- Schweißtestkit im Hartschalenkoffer

050433

Barre d'arrachage / Traction bar  
+ Acier doux / Mild steel 0.65 (x25) + 1.0 (x25)  
+ Acier HSLA 360 - HLE 0.8 (x25) + 1.5 (x25)  
+ Acier DP600 - THLE/UHLE 1.0 (x25)  
+ Acier FB560 - THLE/UHLE 2.5 (x25)

**ANTI-ARC PROTECTION 12V**

- Protection anti-arc 12 V  
- Lichtbogenschutz 12V - Protección anti-arco 12V

041318

**PROTECTION COVER**

- Housse de protection  
- Schutzhaube

050853

for BP & PTI

for PTI GENIUS 077126

**SHEETS SET**

- Échantillons de tôles

Acier standard / Standard steel  
0.8 (x65) + 1 (x55) + 1.5 (x35) + 2 (x25)  
+ Alu  
1 (x45) + 1.5 (x30) + 2 (x20)

055841

**ELECTRODE FORCE SENSOR**

- Capteur d'effort

052314

**TANK DRAINING KIT - Kit de purge réservoir**

- Kit zur Tankentleerung

058286

for GYSPOT BPLC-s7 / BPLCX-s7 / PTI-s7

**SD MEMORY CARD**

- Carte mémoire SD

SD CARD 050914

**KIT WIFI**

for Gyspot Inverter PTI GENIUS 070691

**COOLING LIQUID**

- Liquide de refroidissement  
- Kühlmittel - Enfriamiento líquido - Refrigeração líquida

052246

10L

**G ARMS PANELS**

G2 + G3 + G4 022898

G2 + G3 + G5 063297

**KIT SMALL ACCESS GENIUS for PTI GENIUS 077072**

included SA 073579

+ G1/G3-SA (Small Access) 134

+ G4-SA (Small Access) 150

+ G5/G10/G12-SA (Small Access) 220

+ G8-SA (Small Access) 368



# RIVETING

GYSPRESS 10T	77
GYSPRESS 10T PP	78
GYSPRESS PREMIUM 10T PP	79
WORKSTATION	81
ADAPTERS	83
DIES BOXES & RIVETS	84
ACCESSORIES	87



GYPRESS

# RIVETING

PNEUMATIC HYDRAULIC

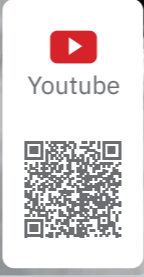

## BRAS DE RIVETAGE - RIVETING ARMS - STANZNIETBÜGEL



	HR110 063310	HR210 063327	HR310 8T PP/10T/10T PP 063334
GYPRESS 8T	✓	✓	—
GYPRESS 10T	✓	✓	✓
GYPRESS 8T PUSH PULL	✓	✓	✓
GYPRESS PREMIUM 10T PUSH PULL	✓	✓	✓
GYPRESS 10T PUSH PULL	✓	✓	✓
GYPRESS 10T CONNECT	✓	✓	✓



**KIT WITH HR210 + HR310**  
064089

**CASE & FOAM WITHOUT ARMS**  
- Valise et mousses sans bras  
077546

**XT31-40**  
Rallonges bras HR310 pour point milieu - HR310 arm extension for middle point

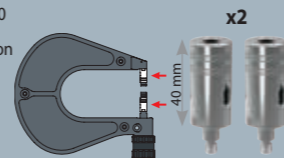

Compatible 8T PP/10T/10T PP x2  
066335

## OPTIONS

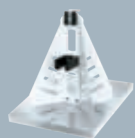

Riveting machine support for changing accessories (arms & dies)  
- Support Riveteuse pour changements d'accessoires (bras & matrice)  
- Supportständer  
↕ 28 x 40 x 21,5 cm  
⊗ 45 x 39 x 20 cm / 7,2 kg  
054158



Trolley - Chariot  
↕ 74 x 51 x 81 cm  
⊗ 80 x 123 x 15 cm / 44 kg  
054233

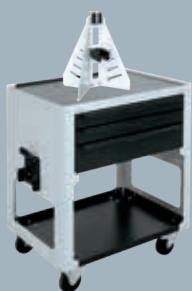

Trolley + Support Chariot + Support  
↕ 51 x 74 x 122 cm  
⊗ 51,2 kg  
055391

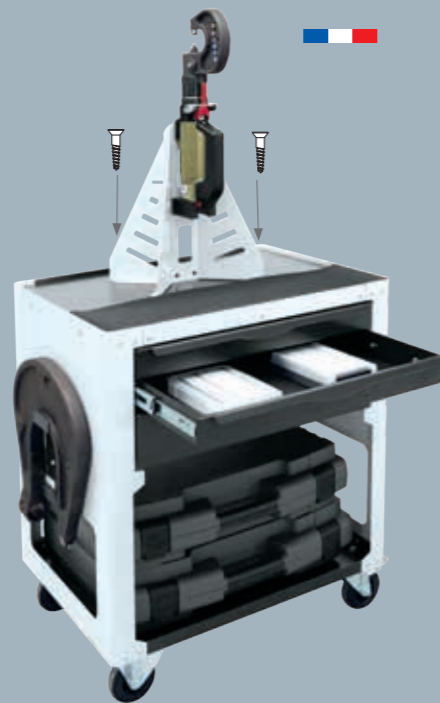

Pressure sensor - Capteur d'effort  
062115

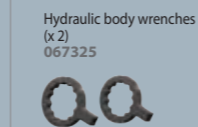

Hydraulic body wrenches (x2)  
067325

Temporary - Serre-tôles - fasteners manual mounting

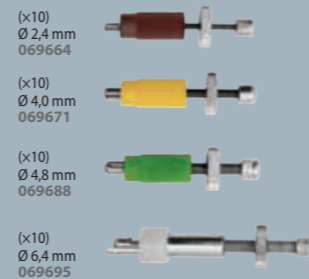

## GYPRESS 10T

6.5 bar | 100 kN

10t

063303



**US version**  
070653



Pressure gauge  
Psi



Discharge lever  
- Levier de décharge - Auslösehebel



Speed control - Contrôle de la vitesse - Regelung  
Werkzeuggeschwindigkeit



Pressure control  
- Contrôle de la pression - Druckregelung



## GYPRESS 10T COMPLETE PACKS

	HR110 063310	XT11.21 - Extension for HR110 & HR210 058644	Standard 10T tool box 053694	6 x 50 rivets RAP - Nieten SPR 048706	HR210 + HR310 064089	50kN adapter 064867	Pulling adapter kit 066076	Trolley+support 055391
<b>GYPRESS 10T</b> 063303 070653			✓					
<b>GYPRESS 10T pack 1</b> 066441				✓				
<b>GYPRESS 10T pack 2</b> 066458					✓			
<b>GYPRESS 10T pack 3</b> 064744								✓

MADE IN FRANCE	AIR BAR	PRESSURE CONTROL	SPEED CONTROL	↕	⚖	📦
				cm	kg	LxWxH cm / kg
<b>GYPRESS 10T</b>	6.5 bar = 10 t (maxi 10 bar)	0 > 6.5 bar	+	39.5 x 180	6.2 (HR110 included)	58 x 50 x 15 / 12.1

GYPRESS

RIVETING



## GYPRESS 10T PUSH PULL

6.5 bar 100 kN  
**10t**

063853

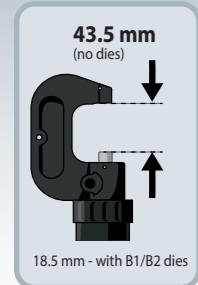

### UNIQUE PUSH PULL SYSTEM by GYS

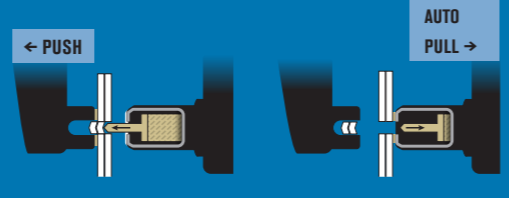

Push/Pull selection  
- Sélection Push/Pull



Pressure control  
- Contrôle de la pression  
- Druckregelung



Speed control  
- Contrôle de la vitesse  
- Regelung Werkzeuggeschwindigkeit



## GYPRESS 10T PUSH PULL COMPLETE PACKS

<b>GYPRESS 10T PUSH PULL</b> 063853	✓						
<b>GYPRESS 10T PP pack 1</b> 066465			✓				
<b>GYPRESS 10T PP pack 2</b> 066472				✓			
<b>GYPRESS 10T PP pack 3</b> 065789			✓				✓

	AIR BAR	PRESSURE CONTROL	SPEED CONTROL			
				cm	kg	LxWxH cm / kg
MADE IN FRANCE	6.5 bar = 10 t (maxi 10 bar)	0 > 6.5 bar	+ -	39.5 x 180	6.7 (HR110 included)	58 x 51 x 17 / 12.8

## GYPRESS PREMIUM 10T PUSH PULL

6.5 bar 100 kN  
**10t**

077065

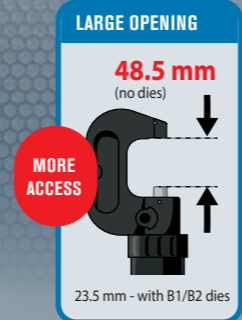

MORE ACCESS



### UNIQUE PUSH PULL SYSTEM by GYS

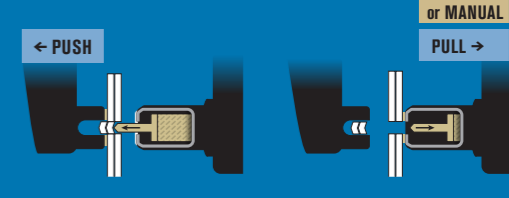

WORK FASTER

Push/Pull selection  
- Sélection Push/Pull



MANUAL PULL MODE

Manual/Automatic selection  
- Sélection Manuel/Automatique



OPENING CONTROL



Pressure control  
- Contrôle de la pression  
- Druckregelung



Speed control  
- Contrôle de la vitesse  
- Regelung Werkzeuggeschwindigkeit



US version  
070660

Pressure gauge  
Psi



## GYPRESS 10T PREMIUM PUSH PULL COMPLETE PACK

<b>GYPRESS PREMIUM 10T PUSH PULL</b> 077065	✓						

	AIR BAR	PRESSURE CONTROL	SPEED CONTROL			
				cm	kg	kg
MADE IN FRANCE	6.5 bar = 10 t (maxi 10 bar)	0 > 6.5 bar	+ -	39.5 x 180	6.7 (HR110 included)	59 x 50 x 16 / 13.1





GYPRESS

# SYNERGIC RIVETING WORKSTATION

PNEUMATIC HYDRAULIC



## ACCESSIBILITY

16 languages

- FR PR CN
- GB CZ JP
- DE NL VN
- IT SE FI
- ES RU TR

★★★★★  
**SYNERGIC RIVETS SETTINGS**

Main panel



Setup instructions

Results

## 3 MODES

- MANUAL
- SYNERGIC
- CAR MANUFACTURERS

## CAR MANUFACTURERS COMPATIBILITY

- ✓ VW GROUP
- ✓ MERCEDES-BENZ
- ✓ BMW
- ✓ TESLA
- ✓ FERRARI
- ✓ FORD
- ✓ RENAULT ALPINE
- ✓ GM

## CONNECTIVITY

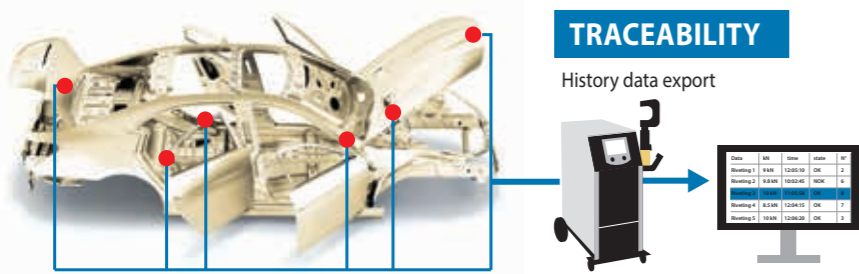

### TRACEABILITY

History data export

### SOFTWARE UPDATE

Gyspress evolutions

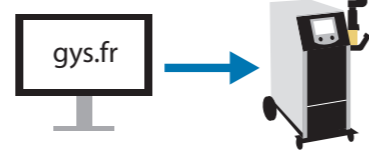

## PUSH PULL SYSTEM by GYS

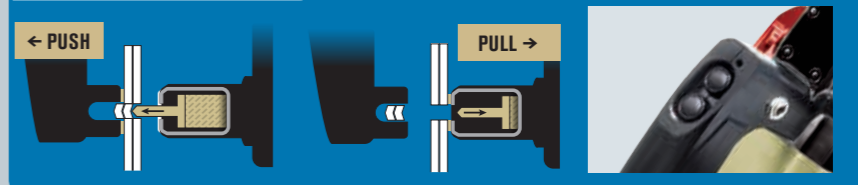

Gyspress support



Arms support



POWER 10t



Discharge lever - Levier de décharge - Auslösehebel

### WORKSTATION GYPRESS 10T PP CONTROL

6.5 bar 100 kN

10t

063860

included



### OPTIONS

Pressure gauge - Capteur d'effort 10T PP CONTROL 071759



Youtube

Hydraulic body wrenches for GYPRESS 10T, 10T PushPull, 10T PP CONTROL (x2) 067325

MADE IN FRANCE WORKSTATION GYPRESS 10T PP CONTROL	230V	AIR BAR 6.5 bar = 10 t (maxi 10 bar)	PRESSURE CONTROL 0 > 6.5 bar	SPEED CONTROL + -	LxWxH cm / kg	LxWxH cm / kg
					74 x 50 x 116 / 54	76 x 42 x 94 / 64.4

**BLIND RIVET ADAPTERS  
- ADAPTATEURS POUR RIVETS AVEUGLES**

GYSPRESS

Adaptators

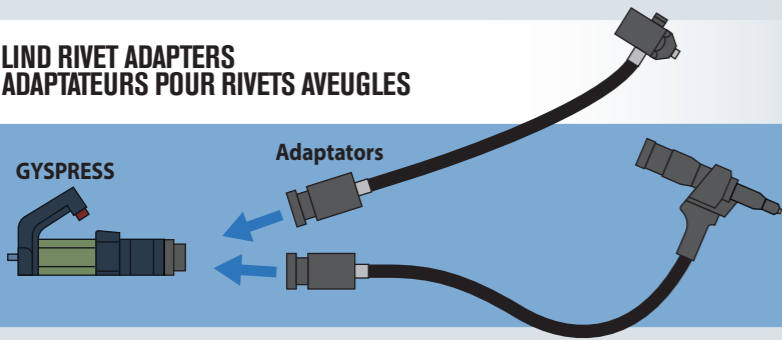

**Compatibility**

- GYSPRESS 10T
- GYSPRESS 10T PUSH PULL
- GYSPRESS 10T PUSH PULL PREMIUM
- GYSPRESS 10T CONNECT



Youtube

**BLIND RIVET ADAPTER 24 kN - Adaptateur 24 kn pour rivets aveugles - Blindnietadapter 24 kN**

HIGH ACCESSIBILITY



SPECIFIC STORAGE



**24 kN STANDARD** 600 mm  
063822

Pour rivets POP - For BLIND rivets - Für Blindniet  
Acier / Steel: Ø 4.0 → 6.4  
Alu: Ø 4.0 → 7.8

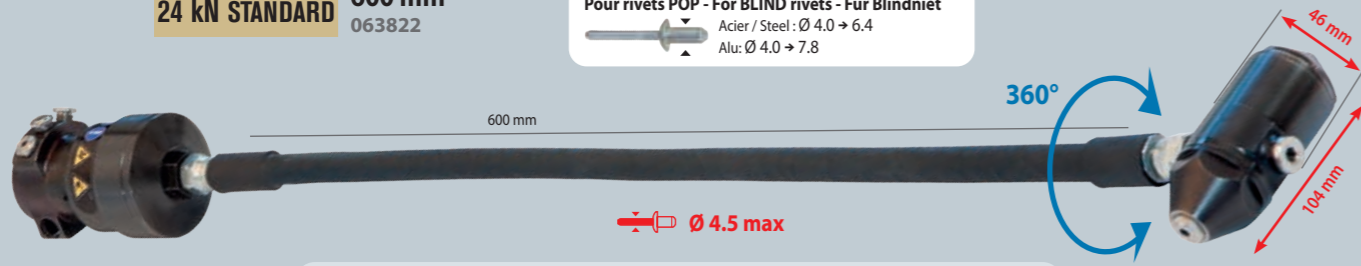

INCLUDED

- 058446
- for standard rivets: Ø 3.2 x 1 059221, Ø 3.6 x 1 059238
- Ø 4.0 x 1 059245, Ø 4.5 x 1 059252

**24 kN COMPACT** 600 mm  
077164

Pour rivets POP - For BLIND rivets - Für Blindniet  
Acier / Steel: Ø 6.4  
Alu: Ø 6.4 → 7.8

COMPACT HEAD



NEW

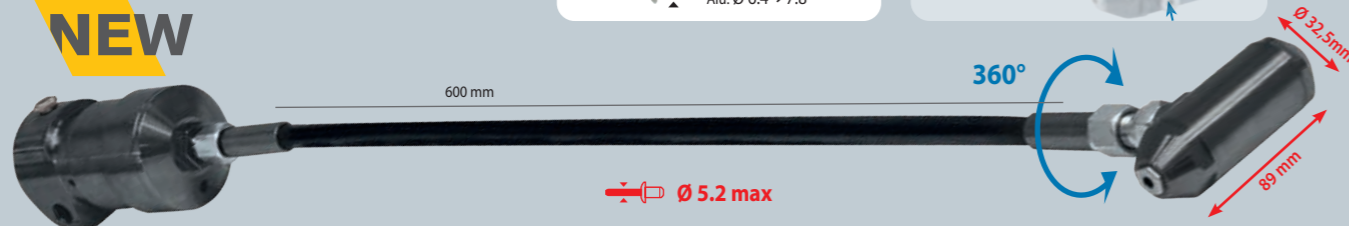

INCLUDED

- 058446
- for standard rivets: Ø 4.5 x 1 081222, Ø 5.2 x 1 079939
- for extraction of self piercing rivet: Rivet-extraction insert - Buse d'extraction 24kN compact Ø 5 079946

**PERFECT COMBO WITH ARCPULL**

**SPECIAL TEARING RIVETS**  
- Spécial arrachage de rivets  
- Spezial-Zugnieten

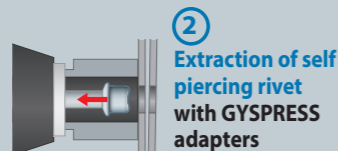
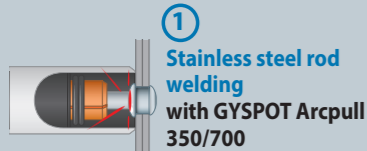

**OPTION FOR GYSPOT ARCPULL (details p.17)**

for GYSPOT ARCPULL 350

**ARC PULL RIVET BOX1 350 - 24kN**  
064584

Stainless steel nail - Tige Inox Ø 4 x 50 mm 064607	Barrel for stainless steel nail welding - Canon pour pose de tige inox 059634	Mandrel support - Support porte-goujon 059634	Nozzle + pad - Buse + patin 059641	mandrel Ø4mm 049000	Buse d'extraction 24kN Ø 4 064683
x100	x1	x1	x1	x1	x1

**BLIND RIVET ADAPTER 50 kN - Adaptateur 50 kn pour rivets aveugles - Blindnietadapter 50 kN**



Stroke adjustment - Réglage de la course de traction  
0 → 25 mm

**50 kN** 1 m  
064867  
4.0 kg

For BLIND rivets - Pour rivets POP - Für Blindniet

Steel / Acier: Ø 4.0 → 6.4  
Alu: Ø 4.0 → 7.8

INCLUDED

Kit Standard



+ Complete kit 065987



OPTIONS

Steel / Acier: Ø 4.0 → 6.4  
Alu: Ø 4.0 → 7.8

**160 mm extension - Extension 160 mm - Verlängerung 160 mm**  
066144



Ø 8.0 → 9.8

**Ø8.0/9.8mm nozzle-piece kit - Kit Rivets Ø8.0/9.8mm - Mundstückkit 8,0/9,8 mm**  
066045



M5 → M14  
M5 → M8

**Blind rivet nut pulling, Blind rivet bolt adapter kit - Kit 6 tirants pour pose d'écrous à sertir et goujons à sertir - Blindnietmuttern, Blindnietgewindebolzen-Kit**  
066076



**OPTION FOR GYSPOT ARCPULL (details p.17)**

for GYSPOT ARCPULL 350

**ARCPULL RIVET BOX2 350 - 50kN**  
073388

Long barrel + mandrel M5 - Canon long + mandrin M5 070738	Mandrel support - Support porte-goujon 059634	Buse + pad 059641	Buse d'extraction 50kN Ø 5 066151
x100	x1	x1	x1

for GYSPOT ARCPULL 700

**ARCPULL RIVET BOX 700**  
068452

Long barrel + mandrel M5 - Canon long + mandrin M5 070738	Buse d'extraction 50kN Ø 5 066151	Mandrel support - Support porte-goujon 071377	Buse + pad 059641	Ring holder 059610	Rod for pulling rings - Fourche pour anneau 071384	Vis de butée
x100	x1	x1	x1	x2	x1	x1

**CONSUMABLES BOX FOR 50KN ADAPTER - Boîte consommables pour adaptateur 50kN - Zubehörbox für 50 kN Adapter**



Blind rivet nuts - Écrous à sertir	Blind rivet bolts - Goujons à sertir	Blind rivets - Rivets aveugles
M5, M6, M8, M10, M12, M14	M5, M6, M8	Ø 6.4, Ø 9.8
0.5 → 3.0, 0.5 → 3.0, 0.5 → 3.0, 1.0 → 3.5, 1.0 → 4.0, 4.5 → 6.0	22.5 → 27, 24 → 28.5, 23.5 → 28	2.8 → 4.8, 3.0 → 14.0
x50, x50, x50, x50, x50, x10	X50, X50, X50	x50, x50
066175, 066182, 066199, 066205, 066212, 066229	066236, 066243, 066250	066267, 066274
+ demo metal sheet - plaque de démonstration	+ x10, x10, x10	+ x10, x10

**Application of self-piercing rivets**  
- Pose de rivets auto-perçants  
- Stanzniet-Verpressen

**Application of solid rivets**  
- Pose de rivets pleins  
- Vollniet-Verpressen

**Application of Flow-form rivets**  
- Pose de rivets Flow-Form  
- Setzen v. Fließformnieten

**Extraction de rivets**  
- Extraction of rivets  
- Niet-Auspressen

**Metal sheet punching and shaping**  
- Perçage et formage des tôles pour rivets pleins  
- Vollniet-Lochstanzen/Prägen

**DIES BOXES - Boîtes matrices - Matrizensätze**

**STANDARD**

**STANDARD 8T/10T**  
for 8T 10T  
053694  
Included XT11-21 058644

x1	x1	x1	x1	x1	x1	x1	x2	x1	x1	x1	x1	x2	x4
A1	A2	B1	B2	F1	F2	D17	E1	E2	T1	T2			
Self-piercing rivets				Flow-form rivets			Extraction		Punching		key	seals	
Ø 3.2, 3.5	Ø 3.3	Ø 5, 5.3	Ø 5.3	Ø 6 - A1/2/3 S0/1/2/3/4/5/6			Ø 3.3, 4.8	Ø 3.9, 5.3	Ø 6				x1

**STANDARD 8T/10T PUSH PULL**  
for 8T PP 10T PP 10T CONTROL  
058361  
Included XT31-60 - 60 mm extension for HR310 (use with ST1, T5, T7) 057135  
+ XT11-21 058644

x1	x1	x1	x1	x1	x1	x2	x1	x1	x1	x1	x1	x2	x4
A1	A2	B1	B2	F1	F2	D17	E1	E2	ST1	T5	T7		
Self-piercing rivets				Flow-form rivets			Extraction		Punching		key	seals	
Ø 3.2, 3.5	Ø 3.3	Ø 5, 5.3	Ø 5.3	Ø 6 - A1/2/3 S0/1/2/3/4/5/6			Ø 3.3, 4.8	Ø 3.9, 5.3	Ø 6				x1

**Low pressure**  
Ø 6.4 mm  
KIT RMB PP05 for 10T PP 10T CONTROL  
Idéal aluminium, aciers doux - Ideal for aluminum, mild steel 066366

**HIGH pressure**  
Ø 6.4 mm  
KIT RMB 08 PREMIUM for 10T 10T PP 10T CONTROL  
Idéal aciers durs, Boron - Ideal for UHSS, Boron 066403

**Flow-Form Ø 6 mm**  
KIT RMB 14 PREMIUM for 10T 10T PP 10T CONTROL  
Idéal aciers durs, Boron - Ideal for UHSS, Boron 071186

**Flow-Form Ø 8 mm**  
KIT RMB 15 PREMIUM for 10T 10T PP 10T CONTROL  
Idéal aciers durs, Boron - Ideal for UHSS, Boron 071193

**Ne pas utiliser avec une Gyspress 8T & 8T PP - Do not use with Gyspress 8T & 8T PP**

**GM**

**RMB 11** for 10T  
071087  
**RMB PP04** for 10T PP 10T CONTROL  
071063  
Included XT31-60 - 60 mm extension for HR310

x1	x1	x1	x1	x1	x1	x1	x1	x1	x1	x1	x3	x1	x1	x2	x2	x4			
F1	F2	F6	E9	E11	T1	T2					T7	T17	T18	T19	D18	D17			
Flow-form rivets				Extraction		Punching									key	seals			
Ø 6				Ø 6.8		Ø 6													

**FERRARI**

**RMB 06** for 8T 10T 8T PP 10T PP 10T CONTROL  
059009

x1	x1	x1	x1	x1	x1	x1	x2	x1	x1	x1	x2	x4			
B4	B5	B6	S3	S7	S8	D17	E1	E2	E13						
Self-piercing rivets						Extraction		Punching				key	seals		
Ø 3.9		Ø 4.75		Ø 3.9		Ø 4.75		Ø 3.3, 4.8		Ø 3.9, 5.3		Ø 4.75			

**VW GROUP**

**RMB 03** for 8T 10T 8T PP 10T PP 10T CONTROL  
054257

x1	x1	x1	x1	x1	x1	x1	x1	x1	x1	x1	x1	x1	x1	x1	x1	x1	x1	x2	x4																		
A1	B1	S3	S7	S8	D8	D9	D17	D1	D2	D3	D4	D13	E2	S1	S4	S5	D5	D6	D7	D10	D11	D12	D15	D16													
Self-piercing rivets				Solid rivets		Extraction										Punching				key	seals																
Ø 3.2, 3.5		Ø 5, 5.3		Ø 3.9		Ø 4.75		Ø 4		Ø 6		Ø 5.3										Ø 3.9, 5.3		Ø 3.2		Ø 5.3		Ø 8		Ø 4.8		Ø 4+8		Ø 4		Ø 6	

**NIO**

**RMB PP08** for 10T 10T PP 10T CONTROL  
072404  
Included XT31-60 - 60 mm extension for HR310

x1	x1	x1	x1	x1	x1	x1	x1	x1	x1	x1	x1	x3	x1	x2	x1	x2	x4				
B1	B2	F1	F2	F6	E2	E3	E9	E11	T5	ST1	T7	T17	T18	T19	D17	D18					
Self-piercing rivets		Flow-form rivets			Extraction									Punching			key	seals			
Ø 5.3		Ø 5.3		Ø 6			Ø 5.3									Ø 6					

**MERCEDES-BENZ**

**RMB 07** for 10T  
064454  
Included XT31-60 - 60 mm extension for HR3 (use with E3, E4, E5, E9, E10, E11) 057135

x1	x1	x1	x1	x1	x1	x1	x1	x1	x1	x1	x1	x1	x1	x1	x1	x1	x1	x1	x2								
F1	F2	F3	F4	F5				E9	E10	E11	T1	T2	T3	T4													
Flow-form rivets								Extraction			Punching							key	seals								
Ø 6 - A1/2/3 S0/1/2/3/4/5/6								S28/38/48/58/68			S08/18			Ø 5.3, 8		Ø 6		Ø 6.8		Ø 8		Ø 6		Ø 6		Ø 8	

**RMB PP01** for 8T PP 10T PP 10T CONTROL  
058378  
Included XT31-60 - 60 mm extension for HR3

x1	x1	x1	x1	x1	x1	x1	x1	x1	x1	x1	x1	x1	x1	x1	x1	x1	x1	x1	x2								
F1	F2	F3	F4	F5				E9	E10	E11	ST1	ST2	T5	T7	T8	T10											
Flow-form rivets								Extraction			Punching							key	seals								
Ø 6 - A1/2/3 S0/1/2/3/4/5/6								S28/38/48/58/68			S08/18			Ø 6.8		Ø 8		Ø 6		Ø 6		Ø 6		Ø 6		Ø 8	

**FORD**

**RMB PP02** for 10T 8T PP 10T PP 10T CONTROL  
058835  
Included XT31-60 - 60 mm extension for HR3 (use with E7 & E12) 057135

x1	x1	x1	x1	x1	x1	x1	x1	x1	x1	x1	x1	x1	x1	x2	x4	
B1	G1	G2	G3	G4	G5	G6	E7	E12								
Self-piercing rivets										Extraction		key		seals		
Ø 5, 5.3										Ø 5, 5.3						

**JAGUAR / LAND ROVER**

**RMB 02** for 8T 10T 8T PP 10T PP 10T CONTROL  
054271

x1	x1	x1	x1	x2	x1	x1	x2	x4
B1	B2	B3	S8	D17	E1	E6		
Self-piercing rivets				Extraction		clé		seals
Ø 5, 5.3		Ø 5.3		Ø 4.8		Ø 4.75		Ø 3.3, 4.8

**BMW**

**RMB 01** for 8T 10T 8T PP 10T PP 10T CONTROL  
054240

x1	x1	x1	x1	x1	x1	x2	x4	
A1	A2	B1	B2	E1	E2			
Self-piercing rivets					Extraction		key	seals
Ø 3.2, 3.5		Ø 3.3		Ø 5, 5.3		Ø 5.3		Ø 3.3, 4.8

**RMB 12** for 10T  
071094  
**RMB PP07** for 10T PP 10T CONTROL  
071070  
Included XT31-60 - 60 mm extension for HR310

x1	x1	x1	x1	x1	x1	x1	x1	x1	x1	x1	x1	x1	x1	x1	x1	x3	x1	x1	x2	x2	x4		
B1	B3	I1	I2	I3	F1	F2	F6	E3	E13	T1	T2			ST1	T5	T7	T17	T18	T19	D18	D17		
Self-piercing rivets						Flow-form rivets			Extraction		Punching									key	seals		
Ø 5, 5.3		Ø 6				Ø 6		Ø 3.3, 4.8		Ø 9		Ø 6											

**PORSCHE**

**RMB 10** for 10T  
069299  
**RMB PP06** for 10T PP 10T CONTROL  
069305  
Included XT31-60 - 60 mm extension for HR310

x1	x1	x1	x1	x1	x1	x1	x1	x1	x1	x1	x1	x1	x1	x1	x1	x3	x1	x2	x2	x4
B3	F2	E9	E11			T1	T2							T5	ST1	T7	T17	T18	T19	D17
Flow-form rivets		Extraction		Punching													key	seals		
Ø 6		Ø 6.8		Ø 6																

**TESLA**





**RMB 09** for 8T 10T 8T PP 10T PP 10T CONTROL  
059931

x1	x1	x1	x1	x1	x1	x1	x1	x1	x1	x1	x1	x1	x1	x1	x1	x1	x1	x2	x4				
B1	H1	H2	H3	H4	H5	H6	H7	H8															
Self-piercing rivets																		key	seals				
Ø 5, 5.3																		Ø 5.3					

**RMB 13** for 10T  
071100  
**RMB PP03** for 8T PP 10T PP 10T CONTROL  
059092  
Included XT31-60 - 60 mm extension for HR3 (use with E2, E3, E9, E10) 057135

x1	x1	x1	x1	x1	x1	x2	x1	x1	x1	x1	x1	x1	x1	x1	x1	x1	x1	x1	x1	x2	x4			
B1	S7	S8	F3	F4	F5	D17	E2	E3	E9	E10														
Self-piercing rivets		Flow-form rivets			Extraction				Punching							key		seals						
Ø 5, 5.3		Ø 4.75			S28/38/48/58/68				S08/18				Ø 3.9, 5.3		Ø 5.3, 8		Ø 6.8		Ø 8		Ø 8		Ø 8	

**DIES - Matrices - Matrizen**

<p>Application of self-piercing rivets - Pose de rivets auto-perçants - Stanzniet-Verpressen</p>  <p>2.0 &lt; 6.5 mm    3 &lt; 5,8 bar</p>	<p>Application of solid rivets - Pose de rivets pleins - Vollniet-Verpressen</p>  <p>2.3 &lt; 8.3 mm    5,3 &lt; 8 bar</p>	<p>Pose de rivets Flow-Form - Application of Flow-form rivets - Setzen v. Fließformnieten</p>  <p>2.3 &lt; 8.3 mm</p>	<p>Extraction of rivets - Extraction de rivets - Niet-Auspressen</p>  <p>2.3 &lt; 8.3 mm    8 bar</p>	<p>Metal sheet punching and shaping - Perçage et formage des tôles pour rivets pleins - Vollniet-Lochstanzen/Prägen</p>  <p>2.3 &lt; 8.3 mm    8 bar</p>
---	---	--	---	---

Ø 8																				
A1	A2	B1	B2	B3	B4	B5	B6	D1	D2	D3	D4	D5	D6	D7	D8	D9	D10	D11	D12	D13
055698	055704	055711	055728	055735	059016	059023	059030	055971	055988	055995	055742	056008	056015	056022	056039	056046	055674	056060	056053	055759
A1+A2				B1+B2																
054295				054301																

D15	D16	D17	D18	E1		E2	E3	E6	E7	E9	E10	E11	E12	E13	F1	F2	F3	F4
056077	056084	055681	071155	055865	054288	055766	057005	057142	057159	058606	058613	058620	058828	059085	055773	055780	055797	055803
E1+E2												F1+F2						
054318												054714						

F5	F6	G1	G2	G3	G4	G5	G6	H1	H2	H3	H4	H5	H6	H7	H8	I1	I2	I3
055810	071148	057173	057180	057197	057203	057210	057227	068230	068247	068254	068261	068278	068285	068292	068308	071117	071124	071131

Ø 6			Ø 6			Ø 6			Ø 8			Ø 6.7							
S1	S3	S4	S5	S7	S8	ST1	ST2	ST3	T1	T2	T3	T4	T5	T7	T8	T10	T12	T13	
057036	057043	057050	057067	057074	057081	058071	058088	066397	057098	059078	057104	055827	055834	058019	058033	058040	058064	066373	066380
T1+T2																			
054707																			

**PATENTED GYS PATENT BREVET GYS**

Ø 6.7		Ø 6		Ø 8							
T14	T15	T16	T17	T18	T19	T20	T21	T22			
066410	066427	068964	066434	069312	069329	071254	069336	070936	070943	071261	070950

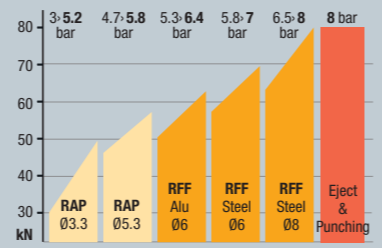

**SELF PIERCING RIVETS (SPR)**  
- Rivets auto-perçants (RAP) - Stanznieten

Steel - Acier - Stahl

Complete box 048706

Ø 3,3 x 3,5 mm x 50	Ø 3,3 x 4 mm x 50	Ø 5,3 x 4 mm x 50	Ø 5,3 x 5 mm x 50	Ø 5,3 x 6 mm x 50	Ø 5,3 x 8 mm x 50	Ø 5,3 x 7 mm	Ø 5,3 x 9 mm
x 200 048232	x 200 048249	x 100 048256	x 100 048263	x 100 048270	x 100 048225	x 100 048638	x 100 048645

**SPECIAL CENTER PUNCH**  
- Pointeau centreur - Spezialekörner



**HYDROPNEUMATIC TOOL FOR BLIND RIVETS**  
- Riveteuse hydro-pneumatique - Hydro-pneum. Blindnietgerät

**HR9**

For BLIND rivets - Pour rivets POP - Für Blindniet



Steel / Acier	Ø 3.2/4.0/4.8
Alu	Ø 3.2/4.0/4.8

**max 9 000 N**

057234



Made in Taiwan

**HYDROPNEUMATIC TOOL FOR BLIND RIVETS**  
- Riveteuse hydro-pneumatique - Hydro-pneum. Blindnietgerät

**HR14**

For BLIND rivets - Pour rivets POP - Für Blindniet



Steel / Acier	Ø 4.0/4.8/6.4
Alu	Ø 4.0/4.8/6.4

**max 14 000 N**

057241



Made in Taiwan

**CORDLESS RIVETER**  
- Akku-Blindnietgerät

**TWO ER20** 064461

For BLIND rivets - Pour rivets POP - Für Blindniet



Ø 4.0/4.8/5.0/6.0/6.4

**max 20 000 N (6 bar)**  
10-20 V universal fast charger (30 min)  
2.0 kg



2x 20V/2Ah Li-ion battery

**MANUAL TOOL FOR BLIND RIVETS**  
- Riveteuse manuelle - Manueller Blindnietgerät

For BLIND rivets - Pour rivets POP - Für Blindniet



Steel / Acier	Ø 3.2/4.0/4.8/6/6.4
Alu	Ø 3.2/4.0/4.8/6/6.4

**061323**



Made in Taiwan

**HYDROPNEUMATIC TOOL FOR RIVET NUTS** - Sertisseuse hydro-pneumatique riv 998 - Hydro-pneum. Blindnietmutterngerät

**RIV 998**

Sealing nuts - Ecrous à sertir - Blindnietmuttern



For sealing nuts from M3 to M12  
Pour la pose d'écrous à sertir M3 à M12

**max 19 000 N (6 bar)**  
included accessories for sealing nuts:  
- livré avec accessoires pour écrous à sertir:  
✓ M3  
✓ M4  
✓ M5  
✓ M6  
✓ M8  
✓ M10  
✓ M12

055414



MADE IN ITALY

**HYDROPNEUMATIC TOOL FOR BLIND RIVETS**  
- Riveteuse hydro-pneumatique - Hydro-pneum. Blindnietgerät

**HR21**

For BLIND rivets - Pour rivets POP - Für Blindniet



Ø 4.0 → 7.8

**max 21 000 N (6 bar)**

055407



included (x3) 058446

For standard rivets Ø 4.0 51508

For Magnarive rivets Ø 4.5 51507

Option HR21 extension 100 mm 063105

MADE IN ITALY



# MIG-MAG

## GMAW-FCAW

### TRADITIONAL

GYS AUTO	90
----------	----

### INVERTER

MULTEPEARL	91
------------	----

E GYS AUTO	92
------------	----

AUTOPULSE	95
-----------	----

ACCESSORIES & CONSUMABLES	98
---------------------------	----

# MIG/MAG TRADITIONAL SYNERGIC

**15 → 200 A**  
Ideal 0,6 mm



**SYNERGIC - EASY TO USE**  
Réglage automatique de la vitesse / Auto adaptative wire speed  
Automatische Einstellung der Drahtgeschwindigkeit

**Capacitor**  
M1GYS AUTO, M3GYS AUTO  
> PERFECT WELD

**M1 GYS AUTO**

15 → 160 A Capacitor

230V • 1~  
032903

208/240V • 1~  
032088

with accessories

**T1 GYS AUTO DV**

15 → 200 A

400V • 3~ / 230V • 3~  
032927

with accessories

**M3 GYS AUTO**

15 → 160 A Capacitor

230V • 1~  
032880

100% READY



**Protection gas**  
Argon+CO<sub>2</sub> (Steel, Inox)  
Argon (ALU/CuSi3/CuAl8)  
CO<sub>2</sub>PUR (Steel)

# MIG/MAG INVERTER SYNERGIC

**SPECIFIC SYNERGIES FOR CAR BODY**

**1 MIG / SYNERGIC**  
Easy to use

- material → Fe, CrNi
- Ø wire → AlMg5, AISi5, CuAl8
- position → CrNi, AISi12, F.C.
- thickness → 0.5 → 6 mm
- Adjust arc length

**2 MIG / MANUAL**  
Enter your parameters

Adjust Spot & Delay

**3 MMA**

**4 TIG lift**

**PFC POWER FACTOR CORRECTION**  
185 V ↔ 265 V

**FV FLEXIBLE VOLTAGE**  
85 V ↔ 265 V

**SR SECONDARY REGULATION**  
1 (A) STABLE



**MULTIPEARL AUTO**

200 A

Ø 200/300

400 PFC FV SR GAS NO GAS MMA TIG

075412

3 m, 2.5 m, 16 mm<sup>2</sup>, 2 m, 16 mm<sup>2</sup>



**Spool Gun Torch**  
- Torche motorisée Spool Gun  
- Spool Gun Brenner

041486

Ø 100

Ideal for  
- Steel / Acier / Stahl  
- Stainless steel / Inox  
- Alu

4m

included 045699

**SPOOL GUN + Support**  
for M3 GYS AUTO

038554

15L/min (FR) 041998  
(UK) 040274  
(NL) 040267  
(IT) 038691

OPTIMAPRO 30L/min (FR) 043619  
(UK) 043626  
(DE) 043633  
(NL) 043640

30L/min (FR) 041622  
(UK) 041646  
(DE) 041219  
(NL) 041615  
(IT) 038707

041332

**M3GYS** : Protection cover  
- Houuse de protection  
- Schutzhaube

052260

041806

MB 15 (150A) 041226

x3 x5 x3

x5 (M6-Ø0,6)  
x5 (M6-Ø0,8)  
x5 (Alu - M6-Ø0,8)

MADE IN FRANCE	MADE IN CHINA	CE 60974/1	50/60 Hz	A	min → max	Reg	100 (spoolgun)	200	300	Electronic Control	EN60974-1 (40°C)			Original equipment Equipement d'origine Originalausstattung Equipamento de fabrica	Protected & compatible power generator (+/-15%)		
											IA (60%)	X% (I2 max)	Ø mm			LxWxH cm / kg	kVA
			230V 1~	16	15 → 160	6	option			400	90	140A@15%	0.6+1	0.6/0.8	0.8	78 x 38 x 67 / 56	4,5 kVA
			208/240V 1~													37 x 79 x 67 / 57.5	
			230V 3~/400V 3~	10	15 → 200	7	option			400	110	150A@25%	0.6+1	0.6/0.8	0.8	37 x 78 x 67 / 62	5,2 kVA
			230V 1~	16	15 → 160	6				400	90	140A@15%	0.6+1	0.6/0.8 0.8/1.0	2 x 0.8	74 x 40 x 85 / 77.5	4,5 kVA
			110V 1~	32	20 → 150	-				400	100	150 A @22%	0.6+1	0.8/1.0	0.8	79 x 30 x 67 / 37.5	7,5 kW
			230V 1~	16	20 → 200	-				400	130	200 A @22%					



E GYS AUTO

# MIG/MAG INVERTER SYNERGIC

Lastest generation  
colour screen 3.5"

**NEW**

16 languages

- French
- English
- German
- Italian
- Spanish
- Portuguese
- Czech
- Polish
- Dutch
- Swedish
- Russian
- Chinese
- Japanese
- Vietnamese
- Finnish
- Turkish

**EASY**



**EXPERT**

Pre-gas / Creep speed / Hotstart /  
Crater filler / Burnback / Post-gas



**EASY TO SETUP**



**MODES**

- MANUEL
- SYNERGIC EASY / EXPERT
- 2T
- 4T
- SPOT
- DELAJ

**FONCTIONS**

- TRACEABILITY
- PORTABILITY
- +500 JOBS can be saved

**SYNERGIES**

- STEEL
- AlSi
- AlMg
- Cu Si 3 / CuAl 8
- CrNi

**UPDATES**



USB key 16 Gb  
062344

**E1 GYS AUTO**

**10 → 200 A**    230V 1~    PFC

with accessories :

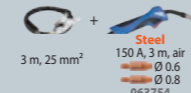

075122

**E2 GYS AUTO**

**10 → 200 A**    230V 1~    PFC

with accessories :

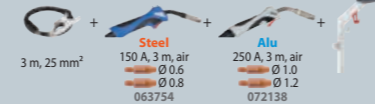

075139

**E3 GYS AUTO**

**10 → 200 A**    230V 1~    PFC

with accessories :



075160

**NEW**



10 m³  
(50L)

1 x

6 m

	E1 GYS AUTO	E2 GYS AUTO	E3 GYS AUTO
1	Ø 200 / 300	Ø 200	Ø 200
2	-	Ø 200 / 300	Ø 200
3	-	-	Ø 200

**10 → 200 A**  
Ideal 0.6 mm

**PFC POWER FACTOR CORRECTION**

195 V ← 265 V

100 m

**NEW**

2 x 4 m³  
(20L)

2 x

6 m

**NEW**

2 x 4 m³  
(20L)

3 x

6 m

**E1 GYS AUTO 200 A • × 1**

**E2 GYS AUTO 200 A • × 2**

**E3 GYS AUTO 200 A • × 3**

MADE IN FRANCE	CE NORM. 60974/1	50/60 Hz	A	6 m	min → max A	Ø mm		Electronic Control	EN60974-1 (40°C)		Original equipment Equipement d'origine Originalausstattung Equipamiento de fabrica	LxWxH cm / kg	Protected & compatible power generator (+/-15%)
						200	300		IA (60%)	X% (I2 max)			
▪	<b>E1 GYS AUTO</b>	230V 1~	16	6 m	10 → 200	▪	▪	⊙	145	20	Acier Type B 0.6/0.8	79 x 37 67 / 42.6	9KVA
▪	<b>E2 GYS AUTO</b>	230V 1~	16	6 m	10 → 200	▪	▪	⊙	145	20	Acier Type B 0.6/0.8 Alu Type B 0.8/1	72 x 37 x 105 / 59.5	9KVA
▪	<b>E3 GYS AUTO</b>	230V 1~	16	6 m	10 → 200	▪	▪	⊙	145	20	Acier Type B 0.6/0.8 Acier Type B 0.8/1 Alu Type B 0.8/1	73 x 38 x 108 / 64	9KVA

E GYS AUTO

SYNERGIC MIG



93

GMAN  
FCAN

92



# MIG/MAG INVERTER DOUBLE PULSE

Latest generation  
colour screen 5"  
800 x 480 (WVGA)



## ACCESSIBILITY

- 3 interface levels
- EASY
- EXPERT
- ADVANCED

- 16 languages
- French
- English
- German
- Italian
- Spanish
- Portuguese
- Czech
- Polish
- Dutch
- Swedish
- Russian
- Chinese
- Japanese
- Vietnamese
- Finnish
- Turkish

EASY



3 INTERFACE LEVELS

ADVANCED  
Arc length adjustments



EXPERT

Pre-gas / Hot Start / Upslope / Downslope / Crater filler / Post-gas



## 500+ JOBS can be saved



## TRACEABILITY



## PORTABILITY



## MODES

- DYNAMIC STANDARD
- PULSE
- PULSE IN PULSE
- MANUAL
- COLD PULSE**

## FULLY DIGITAL

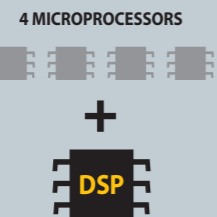

## 65+ SYNERGIES

Find all the synergies: Retrouvez toutes les synergies: Finde alle Synergien:



- STEEL
- Cu Si 3 / Cu Al 8
- ALU

## UPDATES

EASY USB UPDATE



## OPTIONS

### PUSH PULL TORCH 24 V

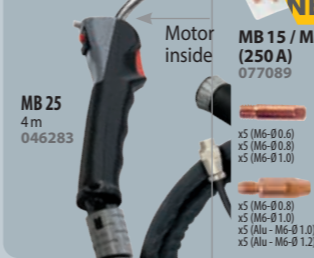

Torch gas flow-meter - Débitmètre de bout de torche  
053939

Protection cover - Housses de protection - Schutzhaube  
052260

## AUTOPULSE 220-M1



ELECTRONIC

## AUTOPULSE 220-M2

1	Ø 200 / 300	PP	
2	Ø 200 / 300		

## AUTOPULSE 220-M1

15 220 A 230V 1~ PFC

with accessories:

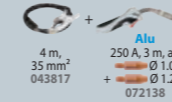

065024

## AUTOPULSE 220-M1 208-240V

15 220 A 208>240V 1~ PFC

with accessories:



070868



## AUTOPULSE 220-M2

15 220 A 230V 1~ PFC

with accessories:

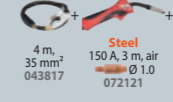

069855

## AUTOPULSE 220-M2 208-240V

15 220 A 208>240V 1~ PFC

with accessories:

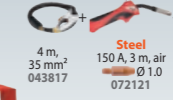

069862



PFC POWER FACTOR CORRECTION

185 V - 265 V



220 A • x1

220 A • x2

MADE IN FRANCE	50 / 60 Hz	A	Ø mm	A	SPOOLGUN	PUSH/PULL	Ø mm	Cooling system	ELECTRONIC CONTROL	IA (60%)	X% (12 max)	LxWxH cm / kg	Protected & compatible power generator (+/-15%)
AUTOPULSE 220-M1	230 V · 1~	8 m	16	0.6+1.2	10+220	OPTION	200	Air	ALU : Type B 1.0 / 1.2	150	220 A @ 20%	75 x 41 x 94 / 65.5	10 kVA
AUTOPULSE 220-M1 208-240V	208 > 240 V · 1~	8 m	16	0.6+1.2	10+220	OPTION	200	Air	ALU : Type B 1.0 / 1.2	150	220 A @ 20%	75 x 41 x 94 / 62.6	10 kVA
AUTOPULSE 220-M2	230 V · 1~	8 m	16	0.6+1.2	10+220	OPTION	200	Air	ACIER : Type B 0.8 / 1.0 mm ALU : Type B 1.0 / 1.2	150	220 A @ 20%	74 x 41 x 93 / 78.8	10 kVA
AUTOPULSE 220-M2 208-240V	208 > 240 V · 1~	8 m	16	0.6+1.2	10+220	OPTION	200	Air	ACIER : Type B 0.8 / 1.0 mm ALU : Type B 1.0 / 1.2	150	220 A @ 20%	74 x 40 x 93 / 79.8	10 kVA





# MIG/MAG INVERTER DOUBLE PULSE

BODYSHOP SPECIFIC  
**COLD PULSE**  
CuSi3 Ø 0.8/1



Helmet not included

2 x 4 m<sup>3</sup>  
(20L)

3 x

8 m

PFC POWER FACTOR CORRECTION

185 V ← 265 V



100 m

**AUTOPULSE 220-M3**

1				PP
2				
3				

**LIC ELECTRONIC**

**AUTOPULSE 220-M3**  
15 **220 A** 230V 1~ PFC

with accessories:  
4 m, 35 mm<sup>2</sup> 043817 + CuSi 150 A, 3 m, air Ø 1.0 072121 + Steel 150 A, 3 m, air Ø 0.8 063754 + Alu 250 A, 3 m, air Ø 1.0 Ø 1.2 072138

**AUTOPULSE 220-M3 208-240V**  
15 **220 A** 208>240V 1~ PFC

with accessories:  
4 m, 35 mm<sup>2</sup> 043817 + CuSi 150 A, 3 m, air Ø 1.0 072121 + Steel 150 A, 3 m, air Ø 0.8 063754 + Alu 250 A, 3 m, air Ø 1.0 Ø 1.2 072138

### OPTIONS

#### PUSH PULL TORCH 24 V



MB 25 4m 046283  
Torch gas flow-meter - Débitmètre de bout de torche 053939

MB 15 / MB 25 (250 A) 077089 **NEW**

Protection cover - Housse de protection - Schutzhaube 052260  
x5 (Mg-Ø 0.6)  
x5 (Mg-Ø 0.8)  
x5 (Mg-Ø 1.0)  
x5 (Mg-Ø 0.8)  
x5 (Mg-Ø 1.0)  
x5 (Alu - Mg-Ø 1.0)  
x5 (Alu - Mg-Ø 1.2)

**AUTOPULSE 320-T1**    **AUTOPULSE 320-T3**    **AUTOPULSE 320-T3 208-240V**

1				PP
2				
3				

**LIC ELECTRONIC**

**AUTOPULSE 320-T1**  
15 **320 A** 400V 3~

with accessories:  
4 m, 35 mm<sup>2</sup> 043817 + Alu 250 A, 3 m, air Ø 1.0 Ø 1.2 072138

069831

**AUTOPULSE 320-T3**  
15 **320 A** 400V 3~

with accessories:  
4 m, 35 mm<sup>2</sup> 043817 + Steel 250 A, 3 m, air Ø 1.0 072152 + Steel 250 A, 3 m, air Ø 0.8 072145 + Alu 250 A, 3 m, air Ø 1.0 Ø 1.2 072138

067615

**AUTOPULSE 320-T3 208-240V**  
15 **320 A** 208>240V 3~ PFC

with accessories:  
4 m, 35 mm<sup>2</sup> 043817 + Steel 250 A, 3 m, air Ø 1.0 072152 + Steel 250 A, 3 m, air Ø 0.8 072145 + Alu 250 A, 3 m, air Ø 1.0 Ø 1.2 072138

036970



10 m<sup>3</sup>  
(50L)

1 x

5 m

3 x

### OPTIONS

for AUTOPULSE 320-T3 (400V) only

#### SPOOLGUN TORCH

#### Ideal Alu



4m 041486  
Motor inside

220 A • x 3

320 A • x 1

320 A • x 3

MADE IN FRANCE EN60974-1	50 / 60 Hz	A	Ø mm	min → max	A	SPOOLGUN	PUSH/PULL	200	Cooling system	Equipement d'origine Original equipment Originalausstattung Equipamiento de fabrica		EN60974-1 (40°C)		LxWxH cm / kg	Protected & compatible power generator (+/-15%)
										ELECTRONIC CONTROL	IA (60%)	X% (I2 max)			
<b>AUTOPULSE 220-M3</b>	230 V · 1~	8 m	16	0.6+1.2	10+220	-	OPTION	■	Air		ACIER : Type B 0.6 / 0.8 ACIER : Type B 0.8 / 1.0 ALU : Type B 1.0 / 1.2	150	220 A @ 20%	75 x 41 x 94 / 80	10 kVA
<b>AUTOPULSE 220-M3 208-240V</b>	208>240 V · 1~	8 m	16	0.6+1.2	10+220	-	OPTION	■	Air		ACIER : Type B 0.6 / 0.8 ACIER : Type B 0.8 / 1.0 ALU : Type B 1.0 / 1.2	150	220 A @ 20%	75 x 41 x 94 / 80	10 kVA

MADE IN FRANCE EN60974-1	50 / 60 Hz	A	Ø mm	min → max	A	SPOOLGUN	PUSH/PULL	200	300	Cooling system	Original equipment Equipement d'origine Originalausstattung Equipamiento de fabrica		EN60974-1 (40°C)		LxWxH cm / kg	Protected & compatible power generator (+/-15%)
											ELECTRONIC CONTROL	IA (60%)	X% (I2 max)			
<b>AUTOPULSE 320-T1</b>	400 V · 3~	5 m	16	0.6+1.2	15+320	-	OPTION	■	■	Air		ALU : Type B 1.0 / 1.2	260	320 A @ 35%	74 x 41 x 94 / 65.1	16 kVA
<b>AUTOPULSE 320-T3</b>	400 V · 3~	5 m	16	0.6+1.2	15+320	OPTION	OPTION	■	-	Air		ACIER : Type C 0.8 / 1.0 mm ALU : Type C 1.0 / 1.2	260	320 A @ 35%	75 x 40 x 94 / 82	16 kVA
<b>AUTOPULSE 320-T3 208-240V</b>	208-240 V · 3~	5 m	25	0.6+1.2	15+320	-	OPTION	■	-	Air		ACIER : Type C 0.8 / 1.0 mm ALU : Type C 1.0 / 1.2	260	320 A @ 35%	74 x 41 x 95 / 82	16 kVA

**MANUAL TORCHES** - Torches manuelles - Brenner - Antorcha - Lastoort - Tocha

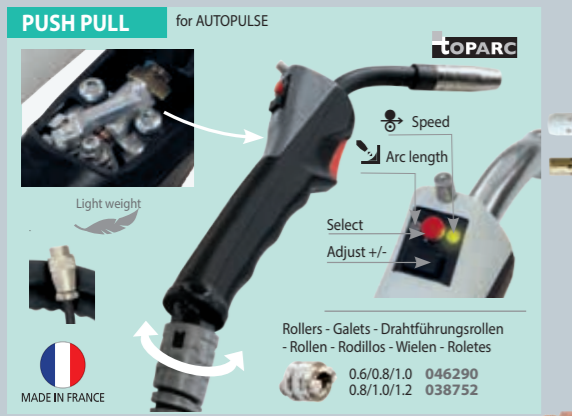
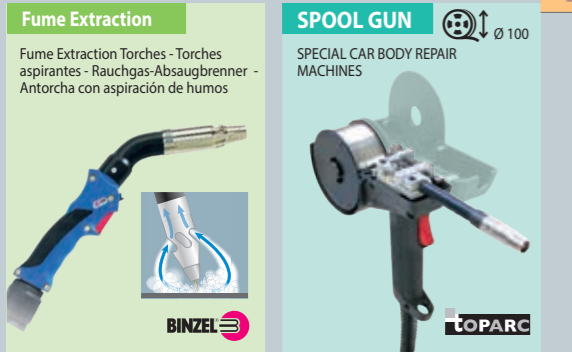

**Boxes** - Coffrets - Verschleißteilebox - Cajas - Kistjes - Estojos

MB 15 (150A) 041226	MB 15 / MB 25 077089	MB 25 (250A) 041233	MB 36 (350A) 041417
x3	x5 (M6-Ø0.6) x5 (M6-Ø0.8) x5 (M6-Ø1.0)	x5	x2
x5	x5 (M6-Ø0.6) x5 (M6-Ø0.8) x5 (Alu - M6-Ø1.0) x5 (Alu - M6-Ø1.2)	x3	x3
x3	x5 (M6-Ø0.6) x5 (M6-Ø0.8) x5 (Alu - M6-Ø1.0)	x3	x2

Guide gaine téflon pour dévidoir 079601 **NEW**

**Torch liners** - Gainses - Mantel - Funda - Drahtseelen - Folha

ACIER - STEEL - STAHL - ACERO - STAAL - AÇO	TEFLON	CARBON
Ø 0.6/0.8	3m 041578 4m 044050 4m 041837 3m 041585	4m 039834 5m 062306
Ø 1.0	3m 041608 4m 041844 5m 062276	4m 039827 5m 062313
Ø 1.2	4m 041844 5m 062276	4m 039810
Ø 1.6	3m 041847 4m 041842 5m 062283	
Ø 1.6	4m 040526 5m 062290	

**PUSH PULL TORCH**  
Ø 1.0/1.2 8m 038172

**CONSUMABLES** - Consumables

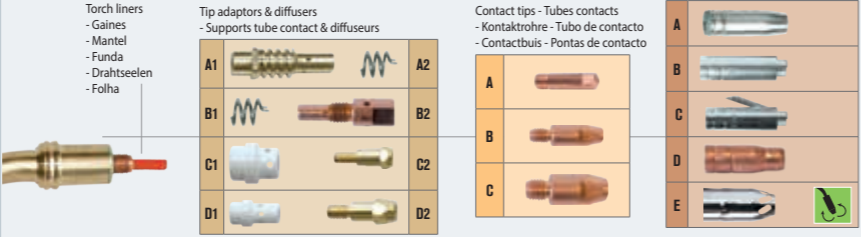

**Complete Torches** - Torches complètes - Brenner - Antorcha - Lastoort - Tocha

X% 40°C ArCo	Acier / Inox - Steel/Stainless steel - Stahl/Edelstahl						ALU - Aluminium - Aluminio					PUSH PULL		SPOOL GUN	
	AIR			LIQUID			AIR			LIQUID		AIR	AIR	AIR	AIR
	150A	150A	250A	250A	350A	300A	150A	250A	250A	350A	300A	150A	250A	150A	150A
	150A 60%	150A 60%	150A 60%	200A 60%	290A 60%	270A 100%	150A 60%	230A 60%	200A 60%	290A 60%	270A 100%	150A 20%	220A 20%	150A 60%	
	A1+A2	A1+A2	B1+B2	B1+B2	D1+D2	C1+C2	A1+A2	B1+B2	B1+B2	D1+D2	C1+C2	B1+B2	M6	M6	M8
	Ø0.8	Ø1.0	Ø0.8	Ø1.0	Ø1.2	Ø1.2	Ø0.8	Ø1.2	Ø1.0	Ø1.2	Ø1.2	Ø1.2	Ø1.2	Ø0.8	Ø0.8
	3m	3m	3m	3m	4m	3m	3m	3m	3m	3m	3m	4m	4m	4m	4m
	063754	072121	072145	072152	063792	040694	063761	072138	063785	063808	040748	046283	041486		
	3m			4m	3m	4m	3m					3m	3m	4m	
	041424			063778	040687	043275	041462					040724	CARBON 040731	043282	
	3m			3m	4m							4m	4m		
	043268			040700	040946							040939	CARBON 040953		
	3m			4m	4m										
	043251			040922	040557										
				3m											
				040540											

**Tip adaptors & diffusers** - Supports tube contact & diffuseurs

Acier / Inox - Steel/Stainless steel - Stahl/Edelstahl	AIR					LIQUID					PUSH PULL			SPOOL GUN		
	150A	150A	250A	250A	350A	300A	150A	250A	250A	350A	300A	150A	250A	150A	150A	150A
A1 (x5)	A1 (x5)	B1 (x5)	B1 (x5)	D1 (x3)	C1 (x3)	A1 (x5)	B1 (x5)	B1 (x5)	D1 (x3)	C1 (x3)	A1 (x5)	B1 (x5)	A1 (x5)			
042902	042902	042995	042995	043008	043589	042902	042995	042995	043008	043589	042902	042995	042902			
A2 (x10)	A2 (x10)	B2 (x5)	B2 (x5)	D2 (x5)	C2 (x5)	A2 (x10)	B2 (x5)	B2 (x5)	D2 (x5)	C2 (x5)	A2 (x10)	B2 (x5)	A2 (x10)			
042988	042988	042919	042919	042926	043541	042988	042919	042919	042926	043541	042988	042919	042988			

**Contact tips** - Tubes contacts - Kontakttrohe - Tubo de contacto - Contactbuis - Pontas de contacto

Ø	Acier / Inox - Steel/Stainless steel - Stahl/Edelstahl						ALU - Aluminium - Aluminio					PUSH PULL			SPOOL GUN		
	150A	150A	250A	250A	350A	300A	150A	250A	250A	350A	300A	150A	250A	150A	150A	150A	
Ø 0.6	A (x10)	A (x10)	A (x10)	A (x10)	—	A (x10)	—	—	—	—	—	—	—	—	—	—	
	041905	041905	041905	041905		041905											
Ø 0.8	A (x10)	A (x10)	B (x10)	B (x10)	C (x10)	B (x10)	B (x10)	A (x10)	B (x10)	—	B (x10)	B (x10)	B (x10)	B (x10)	B (x10)	B (x10)	
	041912	041912	041950	041950	041790	041950	041059	041059	041059		041059	041059	041059	041059	041059	041059	
Ø 1.0	A (x10)	A (x10)	B (x10)	B (x10)	C (x10)	B (x10)	B (x10)	B (x10)	B (x10)	C (x10)	B (x10)	B (x10)	B (x10)	B (x10)	B (x10)	B (x10)	
	041929	041929	041967	041967	0419803	041967	041066	041066	041066	0419766	041066	041066	041066	041066	041066	041066	
Ø 1.2	A (x10)	A (x10)	B (x10)	B (x10)	C (x10)	B (x10)	B (x10)	B (x10)	B (x10)	C (x10)	B (x10)	B (x10)	B (x10)	B (x10)	B (x10)	B (x10)	
	040144	040144	041974	041974	0419810	041974	041073	041073	041073	0419773	041073	041073	041073	041073	041073	041073	
Ø 1.4	—	—	—	—	C (x10)	—	—	—	—	—	—	—	—	—	—	—	
					419827												
Ø 1.6	—	—	—	—	C (x10)	—	—	—	—	—	—	—	—	—	—	—	
					419834												
Ø 2.4	—	—	—	—	C (x10)	—	—	—	—	—	—	—	—	—	—	—	
					040533												

**Gas nozzles** - Buses - Düsen - Tubo - Nippel - Bicos

Conical nozzle Könische Düse	Acier / Inox - Steel/Stainless steel - Stahl/Edelstahl						ALU - Aluminium - Aluminio					PUSH PULL			SPOOL GUN		
	150A	150A	250A	250A	350A	300A	150A	250A	250A	350A	300A	150A	250A	150A	150A	150A	
Ø 0.6/0.8	A (x3)	A (x3)	A (x3)	A (x3)	A (x3)	A (x3)	A (x3)	A (x3)	A (x3)	A (x3)	A (x3)	A (x3)	A (x3)	A (x3)	A (x3)	A (x3)	
	041875	041875	041882	041882	041783	043534	041875	041882	041882	041783	043534	041875	041882	041875			
Spot welding Pointage	B (x1)	B (x1)	—	—	—	—	—	—	—	—	—	—	—	—	—	—	
	041851	041851															
Nail welding Soude-clou	C (x1)	C (x1)	—	—	—	—	—	—	—	—	—	—	—	—	—	—	
	041523	041523															
Special No Gas (isolated)	D (x1)	D (x1)	—	—	—	—	—	—	—	—	—	—	—	—	—	—	
	041868	041868															

**WELDING WIRE REELS** - Bobines de fil - Drahtrollen - Rollos de hilo - Draadbobijn - Bobines de filo

for	kg	Ø	EXCELLIUM					NORMES - Norms - Normen - Norma					
			Ø 0.6 mm	Ø 0.8 mm	Ø 0.9 mm	Ø 1.0 mm	Ø 1.2 mm	AWS	EN	DIN			
Acier - Steel - Stahl - Acero - Staal - Aço (SG2)	0.9	100 mm	086593	086609						5.18 : ER 70S-6	ISO 14341-A : G46 4M G3Si1	8559 : SG2	
	5	200 mm	086111	086128		086135							
	15	300 mm	086166	086227		086234	086241		086302	086319			
	18	—	300 mm		086272		086289	086296					
	5	200 mm	086418	086401							5.18 : ER 70S-3	ISO 14341-A : G42 2M 2Si1	8559 : SG1
	15	300 mm	—	086258							5.28 : ER 90S-B3	ISO 2195L-A : Cr CrMo2Si1	—
	5	200 mm	—	077157							5.28 : ER120 S-G	ISO 16834 : Mn4Ni2, 5CrMo	—
	5	200 mm	—	086203							ASME SFA-5.28 : ER 120 S-G	ISO 12534 : Mn4Ni2, 5CrMo	—
	0.9	100 mm	—		086104								
	4.5	200 mm	—		086265	086623	086630				5.20 : E71T-GS	ISO 17632-A T42 Z W N 1 H15	—
15	300 mm	—		086388	086395								
16	—	300 mm					086173						
5	200 mm	—	086760	086777						5.18 : ER 70S-2	ISO 14341-A : G42 2M G2Ti	8559 : SG2	
1	100 mm	—		086692									
2 kg	200 mm	—		077393						5.7 : ER CuSi-A	ISO 14640 : S Cu 6560	1733 : SG-CuSi3	
5 kg	200 mm	—		086647		086654		086210					
2 kg	200 mm	—		077409									
5 kg	200 mm	—		086661		086197				5.7 : ER CuAl-1	ISO 14640 : S Cu 6100	1733 : SG-CuAl8	
15	300 mm	—				086180							
1	100 mm	—		086616									
5	200 mm	—		086579		086340				5.9 : ER 308L Si	ISO 14343-A : G19 9 L Si	8556 : SG X2CrNi 19 9	
15	300 mm	—				086357							
5	200 mm	—		086326		086364				5.9 : ER 316L Si	ISO 14343-A : G19 12 3 L Si	8556 : SG X2 CrNiMo 19 12	
15	300 mm	—				086371							
2	200 mm	—						086517		5.10 : ER 5554	ISO 18273 : S Al 5554	1732 : SG-AIMg3	
7	300 mm	—						086500					
0.5	100 mm	—		086548									
2	200 mm	—		086555		086562				5.10 : ER 5356	ISO 18273 : S Al 5356	1732 : SG-AIMg5	
7	300 mm	—				086524	086531						
7	—	300 mm							086487	086494			
0.5	100 mm	—		086685									
2	200 mm	—		077133		086142	086159			5.10 : ER 4043	ISO 18273 : S Al 4043-A	1732 : SG-A	



**GYS**

INVEST IN THE FUTURE



# INDUCTION HEATING

1 200 - 22 000 kW

**GYSDUCTION** 102

**COMBIDUCTION** 103

**POWERDUCTION** 105

**ACCESSORIES & CONSUMABLES** 108



# INDUCTION HEATING

CAR BODY

PFC POWER FACTOR CORRECTION

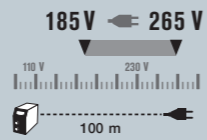

Youtube



NEW

### PACKS - GYSDUCTION AUTO

	PROLINER AUTO 048775	COMPLETE AUTO 053380	COMPLETE AUTO+ 056978	MECA AUTO 048812	MECA AUTO+ 056961	BODY SHOP AUTO 048799	GLASS AUTO 048805	DENT REPAIR AUTO 054981	SMART REPAIR AUTO 079847
GYSDUCTION AUTO	✓	✓	✓	✓	✓	✓	✓	✓	✓
Plastic wedges 051294	✓	✓	✓	-	-	✓	✓	-	✓
Burn off Inductor 053373	✓	✓	✓	-	-	✓	✓	-	✓
Body Inductor 053359	✓	✓	✓	-	-	✓	1 box	-	✓
Bolt Inductor 053366	✓	✓	✓	✓	✓	-	-	-	-
Remote control 055490	✓	✓	✓	✓	✓	✓	-	-	✓
Universal 800 051331	✓	1 box	-	1 box	-	-	-	-	-
Cable support 052284	✓	-	-	-	-	-	-	-	-
Dent pulling Inductor 054776	3 boxes	-	-	-	-	✓	✓	1 box	1 box
Spiral inductor 054783	1 box	1 box	1 box	1 box	1 box	1 box	1 box	1 box	1 box



GYSDUCTION AUTO

2 400 W 230 V • 1 ~

PFC AIR

CONSUMABLES

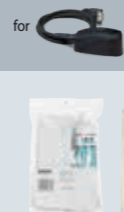

Protection (x5)  
+ Colle - Stick  
053854



Protection (x1)  
+ Colle - Stick  
059108



Protection (x10)  
+ Colle - Stick  
053847

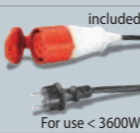

included  
For use < 3600W

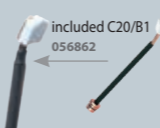

included C20/B1  
056862



COMBIDUCTION AUTO 50LG

5 200 W 230 V • 1 ~

PFC LIQUID

065901

2 in 1

50LG



AUTO

### INCLUDED COMBIDUCTION



Glass - Décapage - Entfernen  
053373



Decal - Décollage - Entkleben  
053359



### OPTIONS

Spiral inductor  
- Inducteur spirale  
- Spiralinductor  
054783



2.5 m 1.2 kW



800 mm  
054813



800 mm  
054868

SIDE



Ø 18 mm	⊙ ≤ M8	054806
Ø 24 mm	⊙ ≤ M12	054790
Ø 30 mm	⊙ ≤ M16	055469

Complete with - Complétez avec - Vervollständigen mit :

SIDE



Ø 21 mm	⊙ ≤ M10	079953	NEW
Ø 27 mm	⊙ ≤ M14	079960	NEW

FRONT



Ø 18 mm	⊙ ≤ M8	079977	NEW
Ø 21 mm	⊙ ≤ M10	079984	NEW
Ø 24 mm	⊙ ≤ M12	079991	NEW
Ø 27 mm	⊙ ≤ M14	080003	NEW
Ø 30 mm	⊙ ≤ M16	080010	NEW

PDR : Paintless Dent Repair  
- Débosselage sans peinture  
- Lackschadenfreies Ausbeulen  
054776

Licensed by  
BETAG innovation



3 m

Freezer spray  
- Spray  
refroidisseur

-50 °C  
400 ml  
(x 12)  
048898

Adhesive for logo  
(x10)  
051492



EN-60335/1	MADE IN FRANCE	A	W	kHz	Tech.	PFC	Liquid Cooling	Cable L (m)		Heating			LxWxH cm / kg	LxWxH cm / kg	Protected & compatible power generator (+/-15%)
								Inductor	Inductor	Heating	Heating	Heating			
GYSDUCTION AUTO	230V, 1~, 50/60 Hz	16 mini	2400	35+100	■	-	-	2	2.5	M10 → 1 s	2 mm → 5 s	Ø8 → 10 s	37 x 21 x 37 / 7.5	52 x 30 x 37 / 12.9	3 kW
COMBIDUCTION AUTO 50LG	230V, 1~, 50/60 Hz	25 mini	5200	20+80	■	■	71	8	3	M14 → 1 s	2 mm → 3 s 4 mm → 5 s	Ø10 → 10 s	46 x 43 x 75 / 60	v	6 kW



# INDUCTION HEATING

# 1.2 → 5.2 kW

MAINTENANCE / MECHANIC / INDUSTRY

NEW

	10R	10R PRO
POWERDUCTION 10R	✓	✓
Flexible 800 mm   054813	✓	✓
Straight 800 mm   054868	✓	✓
<b>SIDE</b>		
Ø 18 mm ⊙ ≤ M8   054806	✓	✓
Ø 21 mm ⊙ ≤ M10   079953	✓	✓
Ø 24 mm ⊙ ≤ M12   054790	✓	✓
Ø 27 mm ⊙ ≤ M14   079960	✓	✓
Ø 30 mm ⊙ ≤ M16   055469	✓	✓
<b>FRONT</b>		
Ø 18 mm ⊙ ≤ M8   079977	✓	✓
Ø 21 mm ⊙ ≤ M10   079984	✓	✓
Ø 24 mm ⊙ ≤ M12   079991	✓	✓
Ø 27 mm ⊙ ≤ M14   080003	✓	✓
Ø 30 mm ⊙ ≤ M16   080010	✓	✓



PFC POWER FACT CORRECTION

185 V ← 265 V



1.5 m



2 m

1 200 W | 230V • 1~ | AIR

POWERDUCTION 10R  
(5 inductors)  
062504  
068643  
080966

POWERDUCTION 10R PRO  
(12 inductors)  
080195  
080300

NEW

POWERDUCTION 37LG

3 700 W | 230V • 1~

\* LIQUID  
056992  
072510  
080959

POWERDUCTION 39LG (C20/B1) | POWERDUCTION 39LG (S90)

3 700 W | 230V • 1~

PFC \* LIQUID  
058583 | 080027

NEW

POWERDUCTION 50LG

5 200 W | 230V • 1~

\* LIQUID  
055599

### OPTIONS 10R

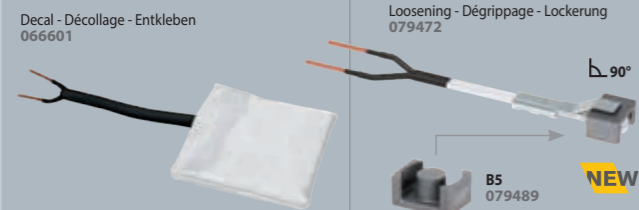

### OPTION 37LG

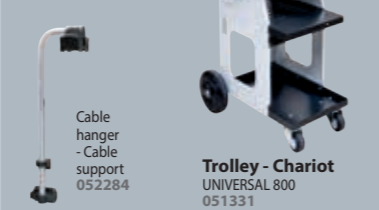

### OPTION 50LG



3 m

3 m

	included	39LG C20/B1	39LG S90
C20/B1   056862	✓	✓	—
285   064485	—	—	✓
S90   058927	—	—	✓

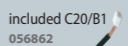

MADE IN FRANCE	Cable L (m)	Heating		Protected & compatible power generator (+/-15%)	L × W × H cm / kg	L × W × H cm / kg									
		Inductor	Heating												
POWERDUCTION 10R / 10R PRO	230V, 1~ / 50/60 Hz	10 mini	1 200	45 → 80	—	—	—	2	1.5	M10 → 1 s	2 mm → 5 s	Ø8 → 10 s	1.5 kW	062504 - 42 × 17 × 37 / 5.4	062504 - 21 × 10 × 15 / 3.3
POWERDUCTION 37LG	230V, 1~ / 50/60 Hz	16 mini	3 700	15 → 30	—	—	1.51	2	2	M10 → 1 s	2 mm → 5 s	Ø10 → 15 s	4 kW	60 × 34 × 33 / 14.5	56 × 26 × 29 / 13
POWERDUCTION 39LG (C20/B1) / (S90)	230V, 1~ / 50/60 Hz	16 mini	3 700	20 → 60	■	■	71	6	3	M12 → 1 s	2 mm → 5 s	Ø10 → 15 s	4 kW	058583 - 81 × 38 × 59 / 52	058583 - 46 × 36 × 70 / 46.5
POWERDUCTION 50LG	230V, 1~ / 50/60 Hz	25 mini	5 200	20 → 60	■	■	71	8	3	M14 → 1 s	2 mm → 3 s / 4 mm → 5 s	Ø10 → 10 s	6 kW	80 × 60 × 60 / 71	46 × 43 × 75 / 58



# INDUCTION HEATING 11 → 22 kW



### OPTION



Powerduction 160/220 LG over hanging arm-pulley  
- Équilibrer Powerduction 160/220 LG  
079441

### t° POWER HEAT CONTROLLER



t° CONTROL 80>350°C (210>660°F)  
5,5m  
POWER HEAT CONTROLLER 061644

Included T° sensors thermocouple type K x2

### OPTION



Pyrometer IR for inductor L90  
1.1 m 064119

included adapter 32L + L90 064515 + 059788

included removable handle 068599

included removable handle 068599

included adapter 32L + L90 064515 + 059788

6 m

included removable handle 068599

included adapter 32L + L20/B4 064515 + 067882

6 m or 10 m

#### POWERDUCTION 110LG

11 000 W 400 V • 3~  
\* LIQUID

058590

#### POWERDUCTION 110LG 208-240V

11 000 W 208-240 V • 3~  
\* LIQUID

065246

#### POWERDUCTION 160LG

16 000 W 400 V • 3~  
\* LIQUID

057814

#### POWERDUCTION 160LG 208-240 V

16 000 W 208-240 V • 3~  
\* LIQUID

065253

#### POWERDUCTION 220LG

22 000 W 400 V • 3~  
\* LIQUID

6 m cable : 066861

10 m cable : 074576

### OPTIONS

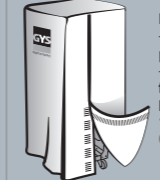

MADE IN FRANCE	Cable L (m)	Freq.	Liquid Cooling	Heating	LxWxH cm / kg	LxWxH cm / kg	Protected & compatible power generator (+/-15%)						
								A	W	kHz	Inductor	Inductor	
POWERDUCTION 110LG	400 V, 3~, 50/60 Hz	16 mini	11 000	20+60	71	5	4	M18 → 1 s	2 mm → 2 s 4 mm → 4 s	Ø10 → 7 s	42 x 42 x 76 / 66.5	59 x 80 x 60 / 86	15 kW
POWERDUCTION 110LG 208-240V	208-240 V, 3~, 50/60 Hz	35 mini	11 000	20+60	71	5	4	M18 → 1 s	2 mm → 2 s 4 mm → 4 s	Ø10 → 7 s	42 x 42 x 76 / 78	59 x 80 x 60 / 90	15 kW
POWERDUCTION 160LG	400 V, 3~, 50/60 Hz	32 mini	16 000	20+60	301	4	6	M20 → 1 s	2 mm → 2 s 4 mm → 4 s	Ø10 → 5 s	78 x 58 x 118 / 128	80 x 61 x 120 / 140	22 kW
POWERDUCTION 160LG 208-240V	208-240 V, 3~, 50/60 Hz	45 mini	16 000	20+60	301	4	6	M20 → 1 s	2 mm → 2 s 4 mm → 4 s	Ø10 → 5 s	78 x 58 x 118 / 113.5	80 x 60 x 120 / 126	22 kW
POWERDUCTION 220LG	400 V, 3~, 50/60 Hz	32 mini	22 000	20+60	301	4	6	M45 → 3 s	4 mm → 3 s 8 mm → 9 s	Ø10 → 4 s	70 x 60 x 120 / 98	80 x 60 x 132 / 139	22 kW
POWERDUCTION 220LG 10M	400 V, 3~, 50/60 Hz	32 mini	22 000	20+60	301	4	10	M45 → 3 s	8 mm → 9 s 4 mm → 3 s	Ø10 → 4 s	70 x 60 x 120 / 132.5	80 x 60 x 120 / 144.5	22 kW

# SMALL Ø16

## INDUCTORS

	S90 058927	S70 061569	S180 059269	S20/B1 (20°) 064874	S180/B1 064881	S180/B2 064928	S180/B3W 067899
37 LG	✓*		✓				✓
39 & 50 LG				✓ with adapter 28S			
110, 160 & 220 LG				✓ with adapter 32S			

	S20/D20 078796	S90/D20 078871	S180/D20 069985
Ø 20	S20/D25 078802	S90/D25 078888	S180/D25 069992
Ø 25	S20/D30 078819	S90/D30 078895	S180/D30 070592
Ø 30	S20/D35 078826	S90/D35 078901	S180/D35 070608
Ø 35	S20/D40 078833	S90/D40 078918	S180/D40 070615
Ø 40	S20/D45 078840	S90/D45 078925	S180/D45 070622
Ø 45	S20/D50 078857	S90/D50 078932	S180/D50 070639
Ø 50	S20/D55 078864	S90/D55 078949	S180/D55 070646
Ø 55			
37 LG	✓ S20/D20-D35, S90/D20-D35, S180/D20-D35		
39 & 50 LG	✓ with adapter 28S		
110, 160 & 220 LG	✓ with adapter 32S		
<b>Protection kit for L180/D inductors</b> - Kit de protection pour inducteurs boucle 077386			

	S180 HEAT TUBE D37 078604	S180 HEAT TUBE D40 078611	S180 HEAT TUBE D50 078628
39 & 50 LG	✓ with adapter 28S		
110, 160 & 220 LG	✓ with adapter 32S		

ADAPTERS	
	28S M28 Ø16 064485
	32S M32 Ø16 064508
39 & 50 LG	✓ 28S M28 Ø16
110, 160 & 220 LG	✓ 32S M32 Ø16

<b>Boxes - Boîtes</b>			
	28S/B type W for 39LG & 50LG 072497	32S/B type W for 110LG, 160LG & 220LG 072503	L box 065796
	included: S20/B1 (x1) S180/B1 (x1) S180/B3 (x1) 28S (x1) B1 (x1) B3 (x1)	included: S20/B1 (x1) S180/B1 (x1) S180/B3 (x1) 32S (x1) B1 (x1) B3 (x1)	included: L70 (x1) L180 (x1)

<b>Trolley for inductor for adapter 32L</b> Chariot pour inducteur pour adaptateur 32L 075955		
	4 to 8 wheels	

<b>Ferrites - Ferrites - Ferritaufsatz</b>						
	B1 053823	B2 053458	B3 067875	B4 053755	B5 079489	Spiral 069701
	B1 (x5) 079380	B2 (x5) 053458	B3 (x5) 067875	B4 (x5) 053755	B5 (x5) 079489	B1 (x5) 079397

<b>Glue kit for inductor</b> Kit de colle pour inducteur 075948	
	EA 9487 Colle-Stick bi-composants Power Epoxy 150°C 054851

# LARGE Ø32

## INDUCTORS

	L90 (90°) 059788	L70 (70°) 059771	L180 059795	L180/Spiral 065000	L20/B4 067882	L180/B4 079786	L20 Alu Glove 069114
39 & 50 LG				✓ with adapter 28L			
110, 160 & 220 LG	✓ with adapter 32L*		✓ with adapter 32L		✓ with adapter 32L*	✓ with adapter 32L	✓ with adapter 32L

	L20/D60 078956	L90/D60 079106	L180/D60 069923
Ø 60	L20/D70 078963	L90/D70 079113	L180/D70 069930
Ø 70	L20/D80 078970	L90/D80 079120	L180/D80 069121
Ø 80	L20/D90 078987	L90/D90 079137	L180/D90 069947
Ø 90	L20/D100 078994	L90/D100 079144	L180/D100 069954
Ø 100	L20/D110 079007	L90/D110 079151	L180/D110 069961
Ø 110	L20/D120 079014	L90/D120 079168	L180/D120 069978
Ø 120	L20/D130 079021	L90/D130 079175	
Ø 130	L20/D140 079038	L90/D140 079182	
Ø 140	L20/D150 079045	L90/D150 079199	
Ø 150	L20/D160 079052	L90/D160 079205	
Ø 160	L20/D170 079069	L90/D170 079212	
Ø 170	L20/D180 079076	L90/D180 079229	
Ø 180	L20/D190 079083	L90/D190 079236	
Ø 190	L20/D200 079090	L90/D200 079243	
Ø 200			Production on request
39 & 50 LG	✓ with adapter 28L		
110, 160 & 220 LG	✓ with adapter 32L		

<b>Protection kit for L180/D inductors</b> - Kit de protection pour inducteurs boucle 077386	
--	--

ADAPTERS	
	28L M28 Ø32 064492
	32L M32 Ø32 064515
39 & 50 LG	✓ 28L M28 Ø32
110, 160 & 220 LG	✓ 32L M32 Ø32

Pre-heating & Fretting - Préchauffage et Frettage			
	L90	L70	L180
Ø 200 < Ø 300	Production on request		
110, 160 & 220 LG	✓ with adapter 32L		

Brasing - Brasage			
	L90 BRAZ 16 Ø 1/2" / 16 mm 076907	L90 BRAZ 28 Ø 1" / 28 mm 076921	L180 BRAZ 16 Ø 1/2" / 16 mm 076914
			L180 BRAZ 28 Ø 1" / 28 mm 076938
110, 160 & 220 LG	✓ with adapter 32L*		

<b>Protection kit for BRAZ inductors</b> - Kit de protection pour inducteurs brasage 077515	
---	--

Exchanger - Échangeur	
	L180R X Production on request
110, 160 & 220 LG	✓ with adapter 32L

# COMPLETE Ø28

## INDUCTORS

C20/B1 056862	C180/B1 056879	C180/B2 056886
37 LG		
39 & 50 LG	✓*	✓
110, 160 & 220 LG		



# PLASMA CUTTING

EASYCUT	112
CUTTER	113





CUTTER

# PLASMA

1~

COMPRESSOR COMPRESSOR INSIDE

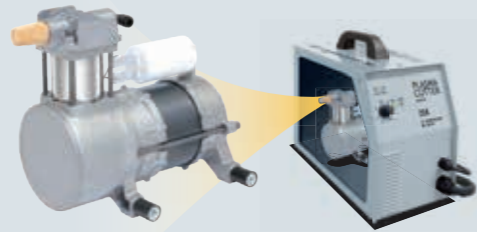

AD ANTI-DUST VENTILATION CORRIDOR

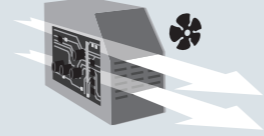

PFC POWER FACTOR CORRECTION

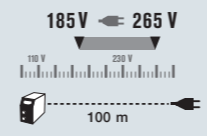

FV FLEXIBLE VOLTAGE

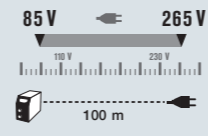

CNC COMPUTER NUMERICAL CONTROL

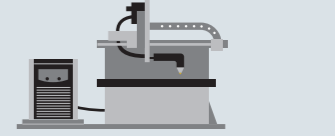

AIR FILTER

PFC EN 61000-3-12 POWER FACTOR CORRECTION



DIGITAL PRESSURE SENSOR



INCLUDED: 8mm



IDEAL CARBODY REPAIR

PFC EN 61000-3-12 FV FLEXIBLE VOLTAGE

DIGITAL PRESSURE SENSOR



INCLUDED: 8mm



DIGITAL PRESSURE SENSOR



COMPRESSOR Compressor inside

<b>EASycut K25</b>
230 V • 1 ~
<b>25 A</b> Fe 8 mm / Al/CrNi 6 mm
P400 COMPRESSOR

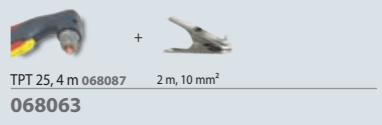

<b>EASycut K35F</b>
230 V • 1 ~
<b>35 A</b> Fe 15 mm / Al/CrNi 10 mm
P400 PFC AD COMPRESSOR

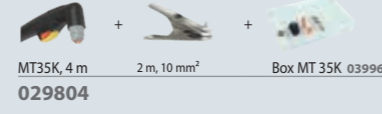
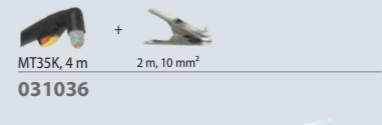

<b>EASycut 25</b>
230 V • 1 ~
<b>25 A</b> Fe 8 mm / Al/CrNi 6 mm
P400 PFC FV

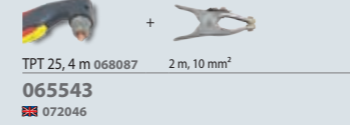

<b>EASycut 30 FV</b>
110 → 230 V • 1 ~
<b>30 A</b> Fe 15 mm / Al/CrNi 10 mm
P400 PFC FV

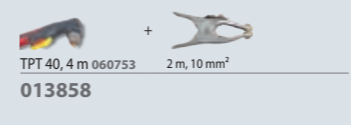

<b>EASycut 40</b>
230 V • 1 ~
<b>40 A</b> Fe 18 mm / Al/CrNi 15 mm
P400 PFC FV

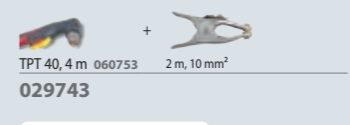

<b>CUTTER 45 CT</b>
110 → 230 V • 1 ~
<b>45 A</b> Fe 30 mm / Al/CrNi 20 mm
P400 PFC FV GRID CUT AD IP 23 CNC ANALOGIC

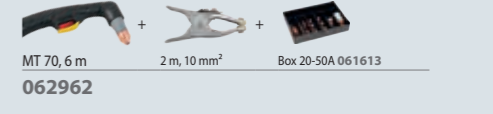
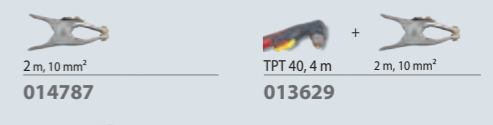

Consumables	MT25K	TPT25	MT35K	TPT40
Torch	x4 040182	x4 040236	x4 040229	x4 040236
Electrode	x10 040151	x10 040212	x10 040212	x10 040212
Shielding gas	x2 040175	x2 040175	x2 040175	x2 040175
Consumable	x10 040168	x10 040168	x10 040168	x10 040168
Box - Coffret	039971	070721	039964	039957

Trolley - Chariot		
PLASMA 600 040298	Universal 800 051331	Jobsite XL 039568
48 x 58 x 62 cm / 8.2 kg	48 x 62 x 81 cm / 17.6 kg	60 x 59 x 115 cm / 18.4 kg
63 x 30 x 11 cm / 8.8 kg	81 x 52 x 15 cm / 18.1 kg	66 x 47 x 20 cm / 19.6 kg

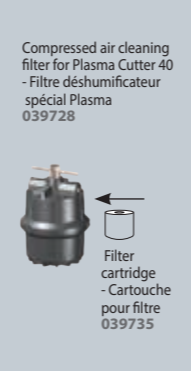

Model	Voltage	I <sub>2</sub>	Cutting Capacity (mm)			INTEGRATED TECHNOLOGY							AIR SYSTEM			EN 60974-1 (40°C)		LxWxH cm / kg	Protected & compatible power generator (+/-15%)						
			Coupe max Severance cut	Coupe propre Clean cut	Perçage Piercing	P400	PFC	FV	GRID CUT	AD	IP23	CNC	COMPRESSOR	min	ideal	max	I <sub>2</sub> max		100%	kVA	kVA				
EASycut K25	230V1~	16	10 → 25	8	6	6	4	—	—	—	—	—	—	—	—	—	included	15 A	35%	—	53 x 31 x 48 / 19	6.5 kW	7.5 kVA		
EASycut K35F	230V1~	16	10 → 35	15	10	10	8	—	—	—	—	—	—	—	—	—	included	28 A	30%	20 A	62 x 33 x 57 / 27	8 kW	10 kVA		
EASycut 25	230V1~	16	10 → 25	8	6	6	4	—	—	—	—	—	—	—	—	—	2.5 bar	4.5 bar	6.5 bar	15 A	30%	10 A	45 x 25 x 35 / 9.7	—	—
EASycut 30FV	230V1~ / 110V1~	16 / 32	10 → 30 / 10 → 30	15 / 10	10 / 10	10 / 8	—	—	—	—	—	—	—	—	—	—	2.5 bar	5 bar	9 bar	23 A / 19 A	30% / 25%	20 A / 15 A	51 x 29 x 37 / 14.3	6.5 kW	6 kVA
EASycut 40	230V1~	16	10 → 40	20	15	15	10	—	—	—	—	—	—	—	—	—	2.5 bar	4.5 bar	6.5 bar	10 A	20%	—	45 x 25 x 35 / 11.5	—	—
CUTTER 45CT	TPT 40	16	15 → 45	20	15	15	10	8	6	—	—	—	—	—	—	—	5 bar	5.2 bar	7 bar	41 A	50%	32 A	51 x 31 x 47 / 16.4	10.5 kW	8 kVA
	MT 70	32	15 → 30	15	10	10	8	—	—	—	—	—	—	—	—	—	5 bar	5.2 bar	7 bar	21 A	25%	17 A			
	MT 70	32	15 → 45	30	20	25	15	12	10	—	—	—	—	—	—	—	5 bar	5.2 bar	7 bar	41 A	50%	32 A			

EASycut / CUTTER PLASMA CUTTING





## + ACCESSORIES

WELDING HELMETS	117
FUME EXTRACTION	121
WINDSCREEN REPAIR	122
BUMPER REPAIR	124
HAND TOOLS	126
PNEUMATIC TOOLS	128
SANDING & DUST EXTRACTION	130
WORKING LIGHTS	132
WORKING SUPPORTS	134
SAFETY PROTECTION	137



# HELMETS

5-9/9-13

## ERGOTECH +

- ◀ 100 x 67 mm
- GRIND
- ULTRA CLEAR 3
- CLASS 1/1/1/1
- TRUECOLOR
- Multi Premium



ERGOTECH + 5-9/9-13  
SILVER  
068650



ERGOTECH + 5-9/9-13  
BLACK  
068667



ERGOTECH + 5-9/9-13  
DREAM  
068674

# PANORAMIC

## APOLLO +

- Fixed shade 5
- 4-5-9/9-13 Adjustable
- Fixed shade 5
- GRIND
- ULTRA CLEAR 3
- CLASS 1/1/1/1
- TRUECOLOR
- Multi Premium



APOLLO + 5-9/9-13 G  
TRUECOLOR  
068681

◀ 100 x 67 mm

0.1 ms

- GRIND
- ULTRA CLEAR 3
- CLASS 1/1/1/1
- TRUECOLOR
- PANORAMIC
- Multi Premium

## ALIEN +



ALIEN XXL +  
TRUECOLOR  
068698

◀ 100 x 90 mm

0.1 ms

- GRIND
- ULTRA CLEAR 3
- CLASS 1/1/1/1
- TRUECOLOR
- Multi Premium



GYSMATIC XL  
TRUECOLOR  
037908

◀ 100 x 60 mm

0.08 ms

- GRIND
- ULTRA CLEAR 3
- CLASS 1/1/1/1
- TRUECOLOR
- Multi Pro



GYSMATIC XXL  
TRUECOLOR  
037236

◀ 100 x 83 mm

0.1 ms

- GRIND
- ULTRA CLEAR 3
- CLASS 1/1/1/1
- DIGITAL
- TRUECOLOR
- MEMORY & REGULATIONS ELECTRONIC



PANORAMIC 3XL  
TRUECOLOR  
037281

◀ 114 x 85 mm

0.15 ms

- GRIND
- ULTRA CLEAR 3
- CLASS 1/1/1/1
- TRUECOLOR
- PANORAMIC
- Multi Premium

OPTIONS



Carry bag for helmet welding  
- Sac pour masque de soudage  
043299



Antiperspirant-headband  
- Bandeau anti-transpiration  
066656



Magnifying glass - Loupe for Zeus, Ergotech & Alien True Color x1  
zoom x2 042780 for Multi Pro x2  
070844 for Gysmatic 9/13 Air, Gysmatic 5/13 Air XXL 064140



LENSES - Verres - Schutzgläser



Model	Size	Weight	Shade	Delay	Class	Grind	HF	Delay	Sensitivity	View	Clear	Color	Options	Weight	Brand	
ERGOTECH +	114 x 133 (x10)	043893	103.7 x 69.5 (x5)	077102	3-5>9/9>13	0.10 ms	✓	0.15 > 0.8 s	1/1/1/1	4 HIGH SENSITIVITY	XL: 100x67 mm	✓	☀ + 2 (CR 2450)	Multi Premium	26 x 24 x 27 / 1000	Gys
ALIEN XXL + TRUECOLOR	114 x 133 (x10)	043893	104 x 96 (x5)	043596	3-5>9/9>13	0.10 ms	✓	0.15 > 0.8 s	1/1/1/1	4 HIGH SENSITIVITY	XXL: 100x90 mm	—	☀ + 2 (CR 2032)	Multi Premium	26 x 24 x 27 / 1000	Gys
GYSMATIC XL TRUECOLOR	110 x 90 (x5)	040816	106 x 66 (x10)	043886	4-5>9/9>13	0.08 ms	✓	0.1 > 0.9s	1/1/1/1	4 HIGH SENSITIVITY	XL: 100x60 mm	✓	☀ + 2 (CR 2450)	Simple	31 x 25 x 25 / 900	Gys
GYSMATIC XXL TRUECOLOR	114 x 133 (x10)	043893	106 x 89.5 (x10)	046825	4-5>9/9>13	0.10 ms	✓	0.1 > 0.9 s	1/1/1/1	4 HIGH SENSITIVITY	XXL: 100x83 mm	✓	☀ + 2 (CR 2450)	Multi Pro	59 x 35 x 29 / 5000	Gys
APOLLO + 5-9/9-13 G	114 x 133 (x10)	043893	103.7 x 69.5 (x5)	077102	3-5>9/9>13 + 2x:5	0.10 ms	—	0.15 > 0.8 s	1/1/1/1	4 HIGH SENSITIVITY	XL: 100x67 + 2x103.7x69.5 mm	✓	☀ + 2 (CR 2450)	Multi Premium	26 x 25 x 28 / 1000	Gys
PANORAMIC 3XL TRUECOLOR	390 x 150 (x3)	037311	special kit (x1)	037304	3-4>8/8>12 + 2x:3>10	0.15 ms	✓	0.15 > 0.8 s	1/1/1/1	4 HIGH SENSITIVITY	114x85 + 2x(68x80) mm	—	☀ + 2 (CR 2450)	Multi	35 x 25 x 22 / 1140	Gys

# HELMETS VENTILATED

IDEAL

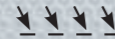

DIGITAL MEMORY & REGULATIONS ELECTRONIC



LCD GYSMATIC 9/13 G  
AIR TRUECOLOR  
065727  
069602

100 x 60 mm

0.08 ms



included with LCD  
GYSMATIC 9 / 13 G  
TRUECOLOR

GYSMATIC 5/13 AIR XXL  
TRUECOLOR  
047846  
028852

100 x 83 mm

0.1 ms



Multi Pro

Filtration class  
EN 12941 : TH2 P R SL  
Air 165 / 200  
220 L/min  
Battery included

OPTION  
Filter TH3  
065734



Battery charger  
037472  
028869



Battery included  
037465



038424 x1



038417 x5

LENSES  
- Verres  
- Schutzgläser

			TRUE COLOR	HF	DELAY									LxWxH cm /g	MASK BRAND	
114x133 (x10)	043893	G: 106x66 (x10)	043886	LCD GYSMATIC 9/13 G TRUECOLOR	4-9>13	0.08 ms	✓	0.10>0.90 s	1/1/1/2	4 HIGH SENSITIVITY	XL: 100x60 mm	✓	+2 (CR 2450)	Simple	28 x 25 x 28 / 1230	Gys
114x133 (x10)	043893	106x89,5 (x10)	046825	GYSMATIC 5/13 AIR XXL TRUECOLOR	4-5>9 /9>13	0.10 ms	✓	0.1 > 0.9 s	1/1/1/1	4 HIGH SENSITIVITY	XXL: 100x83 mm	✓	+2 (CR 2450)	Multi Pro	27 x 25 x 28 / 1000	Gys

## FUME EXTRACTION SYSTEMS - Aspirateurs de fumée - Rauchgasabsauggerät

UNI 2.0 RE

- 400V 3~
- 50 Hz
- 1100 W
- 1500 m<sup>3</sup>/h max
- arm 3 m
- no plug
- 100 kg
- extraction 0.5 m/s

122 x 67 x 145 cm / 111.5 kg

061545



Ø 150 mm

Included  
Pré filtre, treillis Aluminium  
Class of filtration G3 EN 779  
+ Filtre - Coal Filter EPA E12  
EN 779, Filtration >99.5 %  
046467

Options

Filtre à charbon actif -  
Coal filter  
✓ UNI 2.0 RE  
064522

Extraction flexible  
10 m, Ø 152 mm  
✓ UNI 2.0 RE  
✓ EVO 2.1 RE  
062139

EVO 2.1 RE

- 230V 1~
- 50 Hz
- 1100 W
- 1200 m<sup>3</sup>/h max
- occasional
- arm 3 m
- included
- 85 kg

96 x 95 x 162 cm / 114 kg

061552



Ø 150 mm

Patented -  
Breveté

792 mm

347 mm

Included  
Pré filtre, treillis Aluminium  
Class of filtration F15 G2 EN 779  
+ Filtre - Coal Filter HEPA H13  
EN 779, Filtration >99.95%  
046498

## FUME EXTRACTION TORCHES - Torches aspirantes - Rauchgas-Absaugbrenner - Antorcha con aspiración de humos



BINZEL

	Steel/Stainless steel - Acier/Inox - Stahl/Edelstahl			
	AIR		LIQUID	
	150 A	250 A	350 A	500 A
original equipment	M6	M6	M8	M8
Ø	Ø 0.8	Ø 1.0	Ø 1.2	Ø 1.2
X % 40°C - ArCO <sub>2</sub>	150A - 60%	200A - 60%	290A - 60%	380A - 100%
GRIP	GRIP	GRIP	GRIP	GRIP
L	3 m	3 m	4 m	4 m
Ref.	043251	040540	040557	040564

For fume Extraction Torches - Pour torches aspirantes

BINZEL  
073715



- 230V / 1~ , 1100 W
- 230 m<sup>3</sup>/h max
- 190 mbar max
- 25 kg, 590 x 425 x 825 mm
- 76 db
- Filter auto cleaning system - Système de nettoyage automatique du filtre - Automatische Filterabreinigung

Filtre Classe M, EN 60335-2-69

included :  
5 m, Ø50



• External evacuation  
Ø50 (hose not included)  
- Évacuation extérieure  
Ø50 (tuyau non inclus)

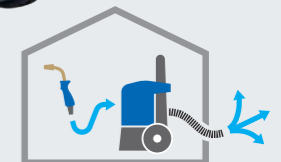

**PROFESSIONAL BOX SET FOR WINDSCREEN REMOVAL** - Coffret de découpe pare-brise  
- Frontscheiben-Trennsystem für Akkuschrauberbetrieb

MADE IN  
HIGH  
QUALITY  
GERMANY

057654

included  
Axe enrouleur  
068100

included  
65 m  
resistance 170 kg  
Ø 0.79 mm  
058125

optional  
65 m  
resistance 190 kg  
Ø 0.92 mm  
069275



**OSCILLATING PNEUMATIC SAW FOR WINDSCREEN REMOVAL** - Couteau pneumatique de découpe pare-brise  
- Druckluft-Trennmesser für Windschutzscheiben

057623



Included  
57 mm  
057845

90 mm  
057852

8 mm  
057876

35 mm  
057838

U  
36 mm  
057869



**REMOVAL TOOL FOR WINDSCREEN WIPER ARMS** - Extracteur d'essuie-glace - Wischerarm-Abzieher

UNIVERSEL  
057630



EXPERT

Accès difficile  
- Difficult access  
057647



**WINDSHIELD CUTTING KIT** - Système de découpe pare-brise à cliquet  
- Set zum Lösen von Windschutzscheiben

054738

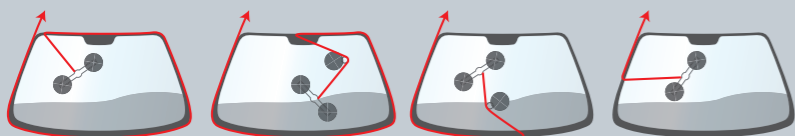

**DASHBOARD PROTECTOR** - Protections tableau de bord  
- Armaturenbrett Schutz

053120



**WINDSHIELD CUTTING TOOL** - Outil découpe pare-brise  
- Windschutzscheiben Demontage-Set

051935



**WINDSCREEN JOINT-CUTTING KIT** - Kit découpe joint de pare-brise - Scheibentrenn-Werkzeug-Set

051898



Corde à piano torsadé (22 m)  
- Windscreen seal cutting wire  
(twisted)  
- Piano-Schneiddraht, gedreht,  
22 m Rolle  
051911

Corde à piano carré (50m)  
- Windscreen seal cutting wire  
(square)  
- Vierkant-Draht,  
50 m Rolle  
051881

**SUCTION LIFTING PADS** - Ventouses - Saugnapfwerkzeug für Spiegelgläser

056695



051966



x6  
057609



**COMPRESSED AIR POLISHER** - Renov'Polycarbonate - Druckluftpolierer

Complete pack

1 orbital sander  
+ 1 polisher  
- 1 ponceuse orbitale  
+ 1 lustreuse

052086



2 SPEED

+

+

+

+

+

+

+

+

+

+

+

+

+

+

+

+

+

+

+

+

+

+

+

+

+

+

+

+

+

+

+

+

+

Ø 76

P 500 (x 10)  
P 800 (x 10)  
P 1500 (x 10)  
P 3000 (x 10)

P 500 x 50 052017  
P 800 x 50 052024  
P 1500 x 50 052031  
P 3000 x 50 052048

polisher Ø75  
058224

052055

052062

052079

sander Ø75  
057494



**HOT STAPLER FOR BUMPER REPAIR - Agrafeuse pour réparation pare-chocs - Stoßstangen Reparatur Kit**

052925

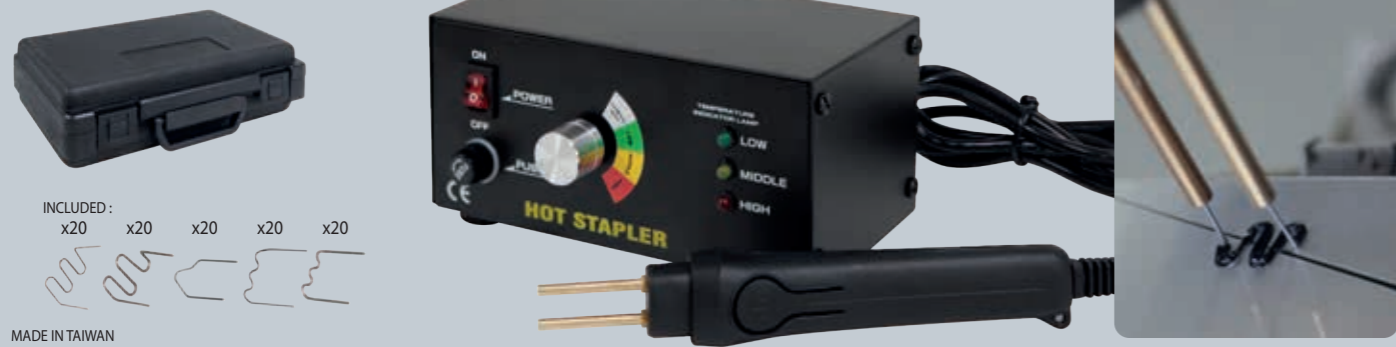

INCLUDED:  
x20 x20 x20 x20 x20

MADE IN TAIWAN

**PORTABLE**  
Battery operated - Sur batterie  
058118

included  
Li-ion battery 3.7V  
048669  
included adapters:  
EUR, UK, USA & AUS

Charger included  
048652

MADE IN TAIWAN



INCLUDED:  
Ø 0.6, x100 Ø 0.8, x100  
Ø 0.6, x100

Staples - Agrafes	V	U	N	W	M
	Inside corner - Angle interne étroit Ø 0.7 mm	Crack alignment - Alignement de fissure Ø 0.7 mm	Large crack - Fissure importante Ø 0.7 mm	Internal angle - Angle interne Ø 0.7 mm	External angle - Angle externe Ø 0.7 mm
	x 100 047990	x 100 047983	x 100 047976	x 100 047969	x 100 047952
052413	= x 50	+ x 50	+ x 50	+ x 50	+ x 50

**PIERCING KIT FOR BUMPER SENSORS - Coffret de perçage pare-chocs pour détecteurs - Lochwerkzeug für Stoßfänger**



PRO+  
059139

Ø 17-18,18,2  
19-20-22,5-24  
26-26,7-32 mm



**FREEZER**

Freezer spray  
- Spray refroidisseur

-50 °C

400 ml

(x 12)

048898



**TOOL FOR REMOVING BUMPER - Outil de déclipsage pare-chocs**

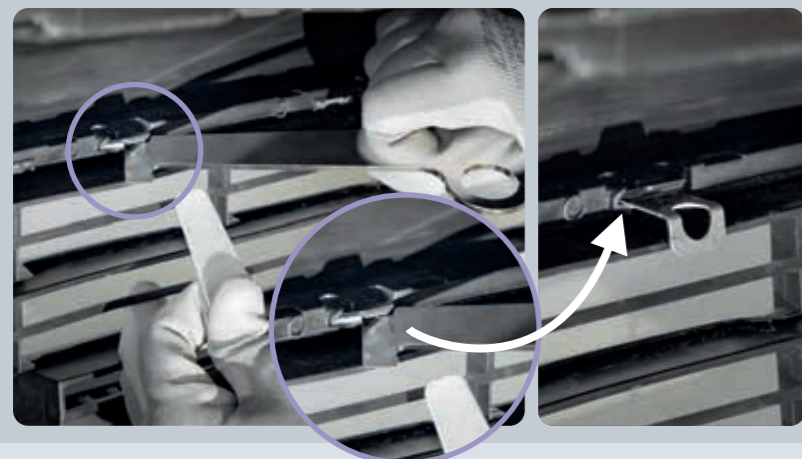

076518

NEW



x15  
076525

**PLASTIC WELDING STATION - Station de soudage des plastiques - Kunststoff-Schweißset**



320 W - 230 V, 1-50 Hz  
Temperature: 160 < 480°C  
▲ 3.4 kg  
Length of hose: 1 m  
Air flow: 24 l/min

Station seule  
- Station only  
064072



Ø 5 mm  
066694  
Ø 8 mm  
066700

plastic rods - baguettes plastique 440 mm	PP / EPDM	▲ 4 mm	x 10	066304
		■ 6 mm	x 10	067622
		■ 8 mm	x 10	066298
	ABS	▲ 4 mm	x 10	071322
		■ 8 mm	x 10	071339

Station	PP/EPDM			Pressure wheels	Mini milling machine	Scraper
	4mm (x10)	6mm (x10)	8mm (x10)			
064072	✓					
070974			✓			

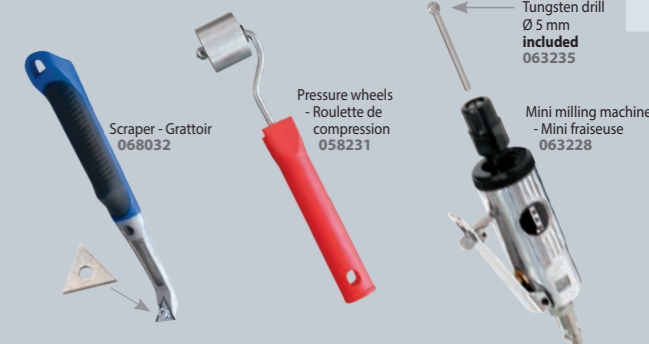

Scraper - Grattoir  
068032

Pressure wheels  
- Roulette de  
compression  
058231

Mini milling machine  
- Mini fraiseuse  
063228



**WELDING KIT FOR PLASTICS - Kit de soudage des plastiques - Kunststoff-Schweißset**



1 600 W - 230V - 50/60 Hz  
max. 230 l/min  
▲ 1.3 kg / -L- Ø100 x 300mm,  
poignée Ø 56mm.

057678

3m

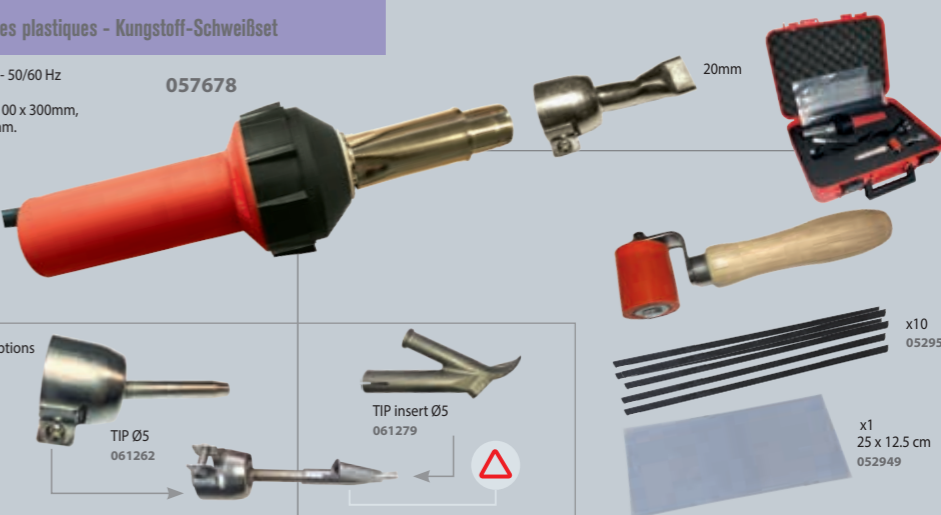

20mm

x10  
052956

x1  
25 x 12.5 cm  
052949

**BRAZING AUTOMOTIVE PLASTICS REPAIR KIT - Coffret de réparation des plastiques automobiles - Kunststoff Reparatur Set**

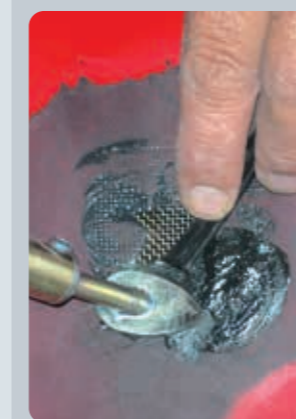

052932

MADE IN BELGIUM

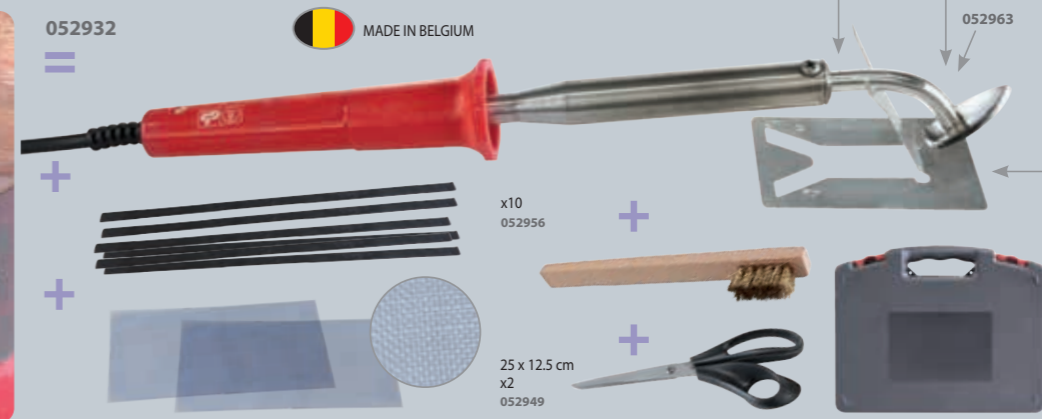

x10  
052956

25 x 12.5 cm  
x2  
052949

052963

057258

**HAND TOOLS - Ausbeulwerkzeug**

• **FULL PACK =**  
061637

MADE IN GERMANY

50 mm  
15  
290 mm  
275 mm  
50 mm  
390 mm  
Ø 50 mm

053311 053298 061309 053335 053342 053328 053281

**MADE IN HIGH QUALITY GERMANY**

+ • **MEDIUM PACK**  
051133

55  
450 mm

051430 051416 051454 051447 051409

051423  
(9 dents/pouce - 9 teeth/inch) 062351  
(15 dents/pouce - 15 teeth/inch) 062368

0.70 kg 051485  
0.95 kg 051478  
1.33 kg 051461

**BURR REMOVER - Outil d'ébavurage - Gratentferner**

**NEW**  
079854

x 10

**PLANISHING HAMMER BLACKTEC®**

077270  
Rubberised gripping - Manche en caoutchouc

**NEW**

MADE IN GERMANY

Corrosion resistant

**CONTOUR GAUGE - Jauges de profil - Kontourenlehre**

052840 250 mm

057265 500 mm

**GAPPING GAUGES - Jauges de positionnement - Spaltmaßlehre**

x2 054752

**FENDER ROLLER TOOL SET - Outil de remise en forme passage de roue**

060791

**ALU HAMMERS - Marteaux alu**

020986

**FORMING TOOLS - Outils de forme - Formgebungswerkzeuge**

051195

180 x 70 x 65 mm  
280 x 95 mm  
280 x 95 mm  
75 x 65 mm

**BODY LINE TOOL - Traceur de ligne carrosserie - Markierhilfe für Kanten**

078758

**NEW**

170 mm max

Dry-wipe marker - Marqueur effaçable à sec

**FIXED HINGE BENDING TOOL - Redresseur de charnière de porte**

40 mm max

051102  
Door hinge straightener - Redresseur de charnière de porte - Türgelenkausrichter

**LIP PLIER - Pince à lèvres - Falzzange gebogen**

079649

**NEW**

45 mm

**PLANISHING KIT FOR CAR BODY (SET OF 3 HAMMERS + 4 DOLLYS) - Kit marteaux et tas - Karosseriehammer & Handfaust Kit**

057579

40 x 40 mm  
70 x 90 mm  
1.4 kg  
061408

117 x 57 mm  
1.2 kg  
061415

117 x 57 mm  
1.2 kg  
061422

**SET OF 30 TOOLS FOR SCRAPING/SANDING AND PAINT REMOVAL - Outils de dégarnissage et raclage - Polster & Schaber Kit**

057616

**POSITIONING CLAMP - Pincettes de maintien bord à bord - I-Stoß-Lehre**

043190 (x4)

**MICRO-GRIP CLAMPS - Pincettes micro-grip**

061330 (x4)

20 mm max

95 mm

**MICRO-WELDING CLAMPS - Micro-brides de soudage**

079373 (x4)

**NEW**

7 mm max

**FLAT NOZE LOCK-GRIP PLIERS - Pincettes étau à bec plat**

062719

250 mm  
100  
max 25  
75  
max 20  
200 mm

**TEMPORARY-FASTENERS MANUAL MOUNTING - Serre-tôles**

(x10) Ø 2,4 mm 069664  
(x10) Ø 4,0 mm 069671  
(x10) Ø 4,8 mm 069688  
(x10) Ø 6,4 mm 069695

**HAND CHISEL FOR CAR BODY - Burins - Meißel für Karosserie**

26 x 7 mm 057586  
26 mm  
230 mm

60 x 11 mm 057593  
60 mm  
245 mm

**SET OF 3 CHISELS - Lot de 3 burins de séparation éléments collés - 3 Meißel**

076754

**NEW**

250 mm  
300 mm  
300 mm

**SET OF 4 NYLON CHISELS - Jeu de 4 burins en nylon - 4 Kunststoffmeißel**

054745

273 mm

19 mm (x1)  
22 mm (x1)  
25 mm (x1)  
38 mm (x1)

**SET OF 3 SCRAPING KNIFES - Couteaux racloirs**

061439

15 mm  
20 mm  
30 mm

**AXIAL-GRIP PLIERS - Pincettes axiales**

050242

Type I Type J Type JJ Type W Type LL Type G

280 mm 061378 x6  
80 mm  
610 mm 061354 x2  
410 mm  
460 mm 061361 x4  
240 mm  
Flat nozzle - 610 mm 061347 x2  
410 mm

**LOCK-GRIP PLIERS - Pincettes étau mono serrage**

Flat nozzle - 460 mm 050112 x6  
240 mm

KIT: 050266 x3 x3 x5 x5 = 16  
Flat nozzle 280 mm



**MINI DISC SANDER** - Mini-meuleuse - Druckluftschleifer

051829

Speed adjustment

Ø 75 mm

Speed rpm	Power W	dB	Air consumption l/min	Air pressure bar	cm	kg
18000	200	83	171	6.2	12	0.7

Included (x1) 052468

**LONG HANDLED ANGLE GRINDER**  
- Meuleuse d'angle - Druckluft-Winkelschleifer

057753

Ø 100 mm

± 1.6 mm, x5 057883  
± 0.8 mm, x5 058217

Speed rpm	Power W	dB	Air consumption l/min	Air pressure bar	cm	kg
14000	84	113	6.2	37	1.7	

058248

x2 Ø  
Ø 50 & 75 mm

Speed rpm	Power W	dB	Air consumption l/min	Air pressure bar	cm	kg
15000	84	91	6.2	10	0.6	

**MINI ANGLE GRINDER** - Mini-meuleuse à renvoi d'angle  
- Mini-Druckluftwinkelschleifer geräuschgedämpft

051867

Ø 50 mm

90°

Speed rpm	Power W	dB	Air consumption l/min	Air pressure bar	cm	kg
15000	200	86	85	6.2	18	0.75

(x1) 052772

**MINI-FLEXIDISC LAMELLES ZIRCON**  
Ø 50 mm

K 40 (x10) 058255  
K 60 (x10) 058262  
K 80 (x10) 058279

**AIR BELT SANDER** - Ponceuse à bande à tête orientable  
- Druckluft Bandschleifer

060906

520 mm

20 mm

360°

Grain 60 (x 5) 060913  
Grain 80 (x 5) 060920  
Grain 100 (x 5) 060937  
Grain 36 céramique (x 5) 062535

Speed rpm	Power W	dB	Air consumption l/min	Air pressure bar	cm	kg
16 000	171	6.3	34	1.2		

**SAW FOR STRAIGHT CUT AND FILE** - Scie coupe tôle droite et lime  
- Druckluftsäge und Feile

051805

(x5) 052789

included 058750

Speed rpm	Power W	dB	Air consumption l/min	Air pressure bar	cm	kg
5000	—	85	255	6.2	10	0.8

**AIR BELT SANDER**  
- Ponceuse à bande à tête orientable  
- Druckluft Bandschleifer

052819

360°

330 mm

10 mm

Grain 80 (x 10) 052833  
Grain 36 céramique (x 20) 062528

Speed rpm	Power W	dB	Air consumption l/min	Air pressure bar	cm	kg
16000	171	6.3	26	0.9		

**MINI ANGLE MILLING MACHINE**  
- Mini-fraiseuse à renvoi d'angle - Mini-Winkelschleifer

051836

90°

Speed rpm	Power W	dB	Air consumption l/min	Air pressure bar	cm	kg
18000	500	81	85	6.2	18	0.7

**AUTOMATIC MANDREL DRILL**  
- Perceuse mandrin automatique  
- Druckluftbohrmaschine m. Schnellspannfutter

051799

Ø 13

Speed rpm	Power W	dB	Air consumption l/min	Air pressure bar	cm	kg
800	300	92	170	6.2	18	0.9

**PNEUMATIC SURFACE REMOVER KIT** - Coffret décapeuse pneumatique - Druckluftentroster-Box inkl. Zubehör

051775

Roue gomme 115 x 14 mm 051874  
Roue à décaper 115 x 14 mm 051843  
Adaptateur pour brosse 051768

Brosse souple Brins droits 0.5 mm 103 x 23 mm 052598  
Brosse dure Brins incurvés 0.7 mm 103 x 23 mm 051812  
Brosse souple Brins incurvés 0.5 mm 103 x 23 mm 051850

Speed rpm	Power W	dB	Air consumption l/min	Air pressure bar	cm	kg
4000	500	86	102	6.2	280	1.2

**PNEUMATIC FLANGE / PUNCHING TOOL**  
- Pince à soyer et à trouser, pneumatique - Pneumatische Loch- und Absatzzange

079892 Ø 8 mm  
0.8 > 1,2 mm

052543 Ø 5 mm  
0.8 > 1,2 mm

2 in 1

0.8 > 1,2 mm

**MINI MILLING MACHINE** - Mini Fraiseuse - Mini-Schleifer

063228

Option  
Tungsten drill Ø 6 mm 054172

**PUNCHING TOOL FOR OVAL HOLES**  
- Outil de poinçonnage oblongs  
- Langlochkarosserieblechzange

2.2 kg

6 mm 20 mm 052437  
8 mm 20 mm 067264

**BODY ZIPPER** - Sertisseuse pneumatique  
Pneumatic Crimper - Druckluftkantenformer

056930

MADE IN HIGH QUALITY POLAND

1) MINI  
2) initial W  
3) final M x < 2.4mm  
4) final D x > 2.4mm

Air pressure bar	cm	kg
5	28	2.1

**LASER CORD METAL SHEET CUTTER (NIBBLER)**  
- Dépointeuse pour cordon laser ACIER  
- Trennwerkzeug für Lasernähte

054165

Ø 6 mm

STEEL Included 054172

**SPOT REMOVER** - Dépointeuse - Druckluft-Schweißpunktbohrer

SPOT DRILL 050464

360°

Ø 8

Included: Tungsten Carbide Ø 8 for BORON/UHSS (x1)

HIGH QUALITY

Spot remover drill - Forets de dépointage - Schweißpunktfräse Tungsten Carbide for BORON/UHSS

Speed rpm	Power W	dB	Air consumption l/min	Air pressure bar	cm	kg
800	400	85	140	6.5	35	2.3

Youtube

**PACK SPOT DRILL + 140 mm**  
061460

3-edge Ø 8 mm 053069

140 mm 061453

**FILM COATING THICKNESS GAUGE**  
- Détecteur épaisseur de peinture

059856

Measurement range : 0 - 1.80mm  
Resolution : 0.01mm / 1mm  
Measurement error : +/- 0.03 mm  
Power Supply : 2x 1.5V AAA batteries (included)  
Overall dimensions : 62 x 30.5 x 105 mm

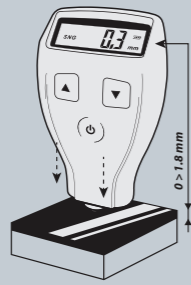

**ELECTRIC SANDER & POLISHER**  
- Ponçeuse /polisseuse électrique - Elektro-Polier-Schleifer

057999

Orbital 5.0 mm  
↓ 27 x 15 x 10 cm / 1.5 kg  
⊗ 37 x 18 x 12 cm / 1.9 kg

Speed : 4000, 7000, 9000 10000 rpm  
AC-in 220V - 230V / 50 - 60Hz

Light weight  
& Compact

Speed control

(( No vibration ))

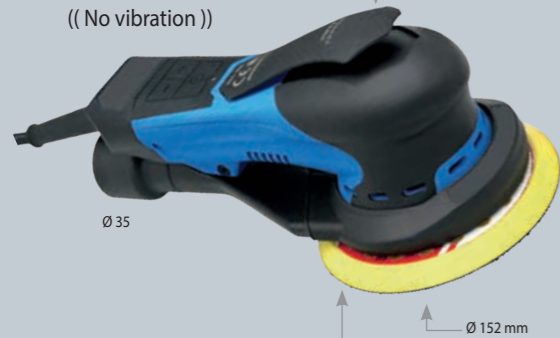

Ø 35

Ø 152 mm

**PNEUMATIC ALUMINIUM DUST ATEX VACUUM CLEANER**  
- Aspirateur pneumatique pour poussières alu (atex)

058866

Dust container capacity : 25 l  
Working compressed air pressure : 7 bar  
Compressed air consumption at 6 bar : 800 l/min  
Suction connection diameter size : 50 mm  
Max suction capacity : 150 m³/h  
Max vacuum level : 2000 mm H₂O  
Recommended compressor power : 7.5 HP

↓ 74 x 45 x 45 cm / 22.5  
⊗ 78 x 58 x 97 cm / 25 kg



058293

Power supply : 230V / 50Hz  
Power : 1400W (max 2000W)  
Max. vacuum : 170 mbar  
Air flow : 2700 l/min  
Drum capacity : 30 L  
Drum material : stainless steel

↓ 33 x 33 x 63 cm / 4.9 kg  
⊗ 38 x 38 x 67 cm / 7.8 kg

Manual or automatic



4m  
Input Ø 32 mm  
Mains cable length 4.5m

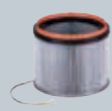

included  
Filtre - Filter  
075405



included  
Sac à poussières - Filter bag  
Capacity 5 kg  
x5  
058880



5 m  
Output Ø 29 mm  
Input Ø 35 mm

**GYS DUST EXTRACTOR** - Pneumatic dust vacuum cleaner for sander

**INNOVATIVE SUCTION SYSTEM**

Depression **1150 mm H2O**  
Air flow **600 l/min**  
Air consumption **340 l/min**



BREVET GYS  
GYS PATENT



Adjustable sander pressure - Pression ponçeuse ajustable  
**5 bar max**

↓ 49 x 48 x 88 cm / 21.5 kg  
⊗ 81 x 40 x 49 cm / 24.1 kg



ATEX norm  
Group II - Category 3

EN 60335-2-69 : 2012

- ✓ **ROBUST**
- ✓ **QUICK & SAFE**
- ✓ **LOW AIR CONSUMPTION**  
(5 bar)
- ✓ **NO ELECTRIC MOTOR**
- ✓ **ENERGY SAVING**

Sanding discs box\*  
- Rangement pour disques de ponçage\*  
\* discs box not included - disques de ponçage non inclus

Grande maniabilité et stabilité  
- High maneuverability and stability

**EASY ACCESS**

Maintenance free  
- Aucune maintenance

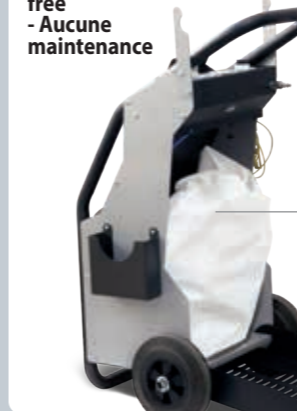

**Consumables**



Sac à poussières - Filter bag  
Capacity 5 kg  
**Included x1**  
x5  
058880



Ponçeuse non fournie  
- Sander not included

5 m  
Ø 29 mm

Option :  
10m  
Ø 29 mm  
076013



Included  
Earth clamp  
safety



Pneumatic Sander  
- Ponçeuse pneumatique  
**MIRKA PROS 650CV**  
Ø 150 mm  
071346

**2 MODELS**

**GYS DUST EXTRACTOR**

**MANUAL**

Manual start  
- Démarrage manuel

071353



**GYS DUST SELF EXTRACTOR**

**AUTOMATIC**

Automatic start  
- Démarrage automatique

077058



**HAND LAMPS - Lampes baladeuses - Handleuchte**

**PORTABLE TRIPOD HAND LAMP 250 L**  
**100-250 lumens (x3)**

3 x 1 W COB LED  
3 x 3.6 V - 300 mAh  
AAA rechargeable, Ni-MH  
USB charging (6h)  
**operating time**  
High position: 1 h  
Low position: 3 h  
Flashing: 5 h

↓ 10 x 10 x 26 cm / 0.6 kg  
⊗ 21 x 11 x 27 cm / 1 kg



**INSPECTION LAMPS**  
- Lampes d'inspection - Inspektionslampen

**INSPECTION HEADTORCH 280 L**  
**100-280 lumens**

3 W COB LED, 80 CRI+, 6500 K  
3.7 V - 1500 mAh Li-po  
micro USB charging  
mains charger not incl.  
**operating time**  
High position: 2 h  
Low position: 6 h  
IP 65  
↓ 8 x 5 x 4 cm / 0.1 kg  
⊗ 5 x 11 x 18 cm / 0.2 kg

060845  
motion detection mode



**PORTABLE HAND LAMP 400 L**  
**400 lumens**

COB LED  
Li-ion  
Charging time: 8h  
**operating time**  
High position: 2.5 h  
Low position: 5 h  
Top light (1 W): 6 h

↓ 7 x 4 x 23 cm / 0.3 kg  
⊗ 14 x 7 x 24 cm / 0.5 kg



**PRO PORTABLE LAMP 600 L**  
**250-600 lumens**

COB LED, 80 CRI  
3.7 V - 2200 mAh Li-ion  
micro USB charging (3.5 h)  
**operating time:**  
High position: 1.5 h,  
Mid position: 4.5 h,  
Top light (100 lumens): 10 h

IP 54  
↓ 3 x 6 x 19 cm / 0.3 kg  
⊗ 9 x 13 x 24 cm / 0.6 kg



**360° PORTABLE WORKSPACE LAMP 1000 L**  
**60-1000 lumens**

>80 CRI SMD LED  
6500 K  
3.7 V - 5200 mAh Li-ion  
USB charging (4.5h)  
USB power supply  
**operating time** 2 > 27 h

IP 54  
↓ 26 x 7 x 7 cm / 0.5 kg  
⊗ 8 x 8 x 35 cm / 0.7 kg

059764



**UNDER BONNET LAMPS - Lampes sous capot - Leuchte für Motorhaube**

**UNDER BONNET HAND LAMP 600 L**  
**500-1000 lumens**

120 COB LED

3.7 V - 4000 mAh Li-ion  
charging time: 10/12 h

**operating time**  
High position: 4 h  
Low position: 8 h

↓ 22 x 11 x 68 cm / 1.8 kg  
⊗ 24 x 12 x 70 cm / 2.3 kg

059962



**UNDER BONNET LAMP AND TRIPOD 800 L**  
**250-800 lumens**

120 COB LED

3.7 V - 4000 mAh Li-ion  
charging time: 10/12 h

**operating time**  
High position: 3 h  
Low position: 6 h

↓ 60 x 10 x 7 cm / 1.2 kg  
⊗ 61 x 15 x 12 cm / 2 kg

058002  
058316

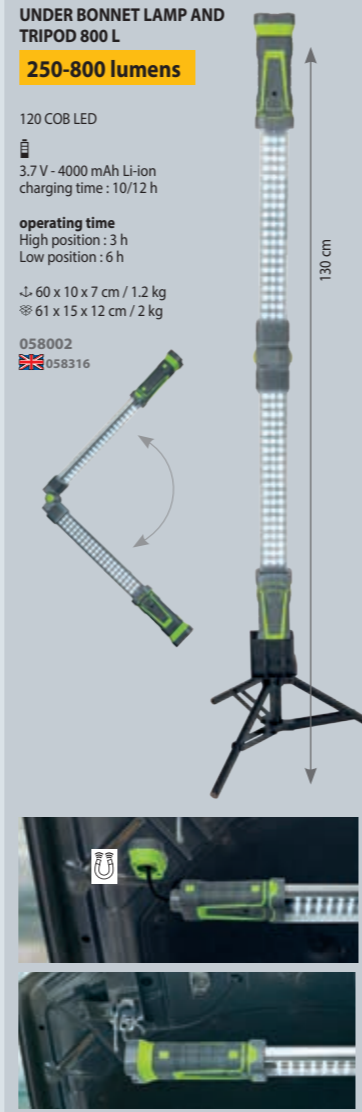

**LED WORKLIGHTS WITH TRIPOD - Projecteurs led sur trépied - LED-Arbeitsleuchte mit Standfuß**

**TRIPOD LAMP 1800 L**  
**1800 lumens**

3 x 55 COB LED  
total 165 LED

1.8 m power cord

059146

⊗ 95 x 15 x 14 cm / 3.2 kg

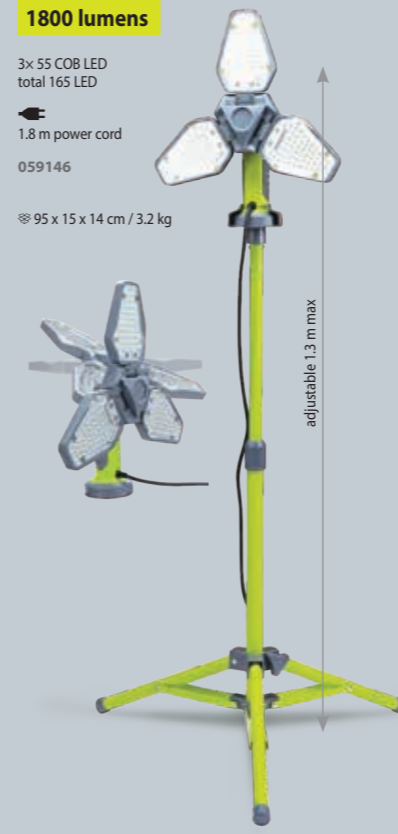

**TRIPOD LAMP 3000 L**  
**3000 lumens**

35 W COB LED

2 m power cord

IP 44

059979

↓ 100 x 20 x 9 cm / 3.6 kg  
⊗ 103 x 22 x 10 cm / 4.1 kg



**TRIPOD LAMP 4000 L**  
**4000 lumens**

3 x 20 COB LED,  
total 60 LED

3 m power cord

059986

↓ 21 x 15 x 114 cm / 5.7 kg  
⊗ 22 x 116 x 117 cm / 6.4 kg



**MINI INSPECTION LAMP 200 L**  
**120-200 lumens**

COB LED, 80 CRI, 6500 K  
3.7 V - 700 mAh Li-ion  
micro USB charging (2.5 h)  
mains charger not included  
**operating time**  
High position: 1.5 h  
Low position: 4 h  
Top light: 3.5 h  
IP 20  
↓ 18 x 3 x 3 cm / 0.1 kg  
⊗ 18 x 5 x 3 cm / 0.2 kg

060852



**MINI INSPECTION LAMP 350 L**  
**0-350 lumens**

COB LED  
3.7 V - 1100 mAh Li-ion  
USB charging (3 h)

**operating time**  
3 > 6.5 h

IP 20

075894



**PRO INSPECTION LAMP 600 L**  
**0-600 lumens**

COB LED  
6500 K  
3.7 V - 2600 mAh Li-ion  
**operating time**  
1.5 > 15 h

↓ 38 x 4 x 5 cm / 0.3 kg  
⊗ 40 x 9 x 6 cm / 0.4 kg

057760  
058309



**PRO INSPECTION LAMP 800 L**  
**120-800 lumens**

COB LED  
3.7 V - 2600 mAh Li-ion  
USB charging (4 h)

**operating time**  
2.5 > 9 h

IP 54

075900



**DETAILING & COLOUR MATCH - Contrôle des couleurs - Fabnpassung & Aufbereitung**

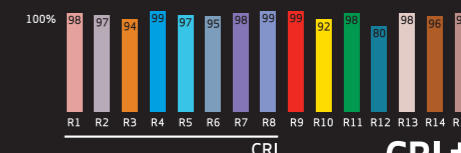

**4500 K**  
**400 lumens**

**SUNCOLOR 1**  
COB LED, CRI > 95, 1100 lux  
3.7 V - 2600 mAh Li-ion  
USB charging  
**operating time:** 3 h  
↓ 6 x 3 x 19 cm / 0.6 kg  
⊗ 22 x 14 x 10 cm / 0.7 kg  
IP 65

058477



**3 COLORS**  
**2700 - 4500 - 6500 K**  
**350-420-450 lumens**

**SUNCOLOR 3**  
COB LED, 96 CRI+  
3.7 V - 2600 mAh Li-ion  
micro USB charging (4 h)  
**operating time:** 2.5/4 h  
IP 65  
↓ 4 x 6 x 9 cm / 0.3 kg  
⊗ 9 x 13 x 24 cm / 0.6 kg

060838



**5 COLORS**  
**2700 - 3500 - 4500 - 5500 - 6500 K**  
**500-1000-2000 lumens**

**SUNCOLOR 5**  
COB LED, 96 CRI+  
11.1 V - 4400 mAh Li-ion  
charger 110/240 V, 5 m cable, 15 V, 1.5 A  
charging time: 3.5 h  
**operating time**  
High position: 2 h, Mid: 4 h, Low: 8 h  
IP 65  
↓ 7 x 23 x 20 cm / 1.2 kg  
⊗ 9 x 25 x 24 cm / 1.9 kg

060876



**5 COLORS**  
**2500-3500-4500-5500-6500 K**  
**250-500 lumens**

**SUNMATCH 3**  
COB LED, 96 CRI+, 700-1400 lux  
3.7 V - 2600 mAh Li-ion, USB charging  
**operating time:**  
High position: 2 h, Low position: 4 h  
IP 65  
↓ 4 x 6 x 19 cm / 0.3 kg  
⊗ 8 x 9 x 21 cm / 0.5 kg

061651

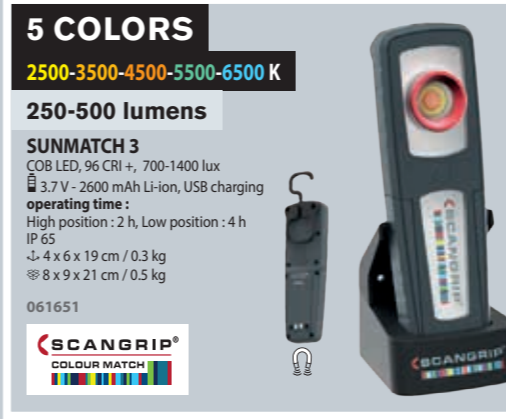

**UV CURING - SÉCHAGE UV**  
**UV LED λ 395-400 nm**  
**Irradiance 6-15 mW/cm²**

**NOVA-UV S**  
3.7 V - 5400 mAh Li-ion  
USB charger, 1 m cable, 5 V, 2 A  
charging time: 3.5 h  
curing area: Ø 20 cm  
**operating time 1.5 h**  
IP 67  
↓ 7 x 17 x 16 cm / 0.9 kg  
⊗ 7 x 17 x 18 cm / 1 kg

061620



**FRAMES SUPPORT - Tréteaux - Klappböcke**

**040601**  
↓ 105 x 33 x 9 cm / 6.3 kg  
⊗ 107 x 35 x 10 cm / 6.7 kg  
Ø28 mm  
**Bent feet for grating**  
- 4 pieds courbes  
- Idéal sur caillbotis  
- Abgewinkelte Standfüße:  
- Sicherer Stand auf Gittern u.ä.

**040250**  
↓ 100 x 105 cm - 7.1 kg  
⊗ 104 x 10 x 32 cm / 7.5 kg  
Ø32 mm

**040311**  
↓ 106 x 31 x 6 cm / 6.6 kg  
⊗ 106 x 31 x 11 cm / 9.7 kg  
Ø32 mm  
**Suction pad for glazing**  
- 4 ventouses  
- Dépose vitrages  
- Gummiteiler zur Fixierung  
- von Glasscheiben

**040304**  
↓ 105 x 109 cm / 7.2 kg  
⊗ 107 x 32 x 10 cm / 7.8 kg  
Ø32 mm  
**Light and easy to handle**  
- Idéal for horizontal works  
- Léger et très maniable  
- Spécial travaux à l'horizontal  
- Speziell geeignet für Arbeiten  
- in horizontaler Position

**070677**  
20 x 20 mm 16.5 kg  
MADE IN HIGH QUALITY POLAND  
15 > 125 cm  
88 > 128 cm  
3 mm  
87 cm

Adjustable catenary - Chainette réglable  
Protecting foam - Mousse de protection  
Non-slip base - Antidérapants

**PREMIUM MASKING MACHINE**  
- Chariot de luxe marouflage  
- Abdeckpapier-Ständer

**057333**  
150 x 133 x 62 cm  
31 kg  
⊗ 152 x 30 x 18 cm / 31.5 kg

**056954**  
150 x 62 x 110 cm / 11 kg  
⊗ 154 x 30 x 19 cm / 12 kg

**MADE IN HIGH QUALITY POLAND**

**x 5 (not included)**  
Paper roll - Rouleaux de papier  
- Papierständer  
30 > 120 cm  
Ø 75 mm  
Ø 250 mm

**OPTION**  
Ø 40 mm x 6  
058897

**x 3 (not included)**  
Paper roll - Rouleaux de papier  
- Papierständer  
30, 60, 90 cm  
Ø 75 mm  
Ø 250 mm

**STORAGE TROLLEY - Chariot de stockage - Lagerrollwagen**

**040243**  
71 x 90 x 197 cm  
41 kg  
⊗ 2:  
90 x 6 x 147 cm  
+ 97 x 74 x 24 cm

**FLAP LOCK - Tiges de blocage**

**056732**  
30 > 115 cm

**ROTARY ELEMENT SUPPORT - Support pare-chocs**  
- Lackierständer für Stoßstange, einstellbar

**052376**  
↓ 50 x 70 x 10 cm / 7.3 kg  
⊗ 60 x 77 x 12 cm / 8.3 kg

**059825**  
106 x 104 x 215 cm - 32.5 kg  
112 x 31.5 x 21.5 cm  
+ 12 x 9.5 x 194.5 cm

**059832**  
↓ 50 x 150 cm - 11.3 kg  
⊗ 155 x 18 x 12 cm / 13.8 kg

Adapté aux coques de rétroviseurs  
- Adapted to wing mirror covers  
- Geeignet für Außenspiegel

**UNIVERSAL SUPPORT - Chariot pour éléments de carrosserie**  
- Universelle Ständer

**066281**  
⊗ 120 x 80 x 13 cm / 24 kg

**NEW**  
max 80 kg  
Ø 4.5 cm  
80 cm  
70-100 cm  
115 cm  
Ø 12.5 cm

**MADE IN HIGH QUALITY POLAND**

**ROUND STOOL WITH TOOL STORAGE**  
- Tabouret - Werkstatt-Rollhocker

**057555**  
38 x 38 x 44 cm - 5.2 kg  
⊗ 41 x 19 x 41 cm / 5.6 kg

max: 50 cm  
min: 38 cm  
6 cm

**MECHANICS CREEPER WITH TILTING HEADREST**  
- Chariot de visite - Werkstatt-Rollliege

**057548**  
102 x 43 x 11 cm / 5.3 kg  
⊗ 104 x 45 x 13 cm / 6 kg

**ROUND STOOL WITH STORAGE**  
- Tabouret d'atelier 3 tiroirs

**079878**  
47 x 35 x 43 cm  
38.5 x 37 x 38.5 cm - 13 kg

**NEW**

**ROTARY ELEMENT SUPPORT - Support élément rotatif**  
- Lackierständer für Stoßstange, einstellbar

**052611**  
200 x 101 cm - 19 kg  
⊗ 112 x 35 x 13 cm / 23 kg  
Made in China

**PRO 056725**  
200 x 105 x 81 cm - 21.5 kg  
⊗ 120 x 26 x 18 cm / 22 kg

1.5 mm  
360°  
2 mm  
Verrouillage de l'axe - Locking of the axis  
- Verriegelung der Achse

**MADE IN HIGH QUALITY POLAND**

**EXTENDABLE SUPPORT - Chariot extensible pour éléments de carrosserie**  
- Ausziehbarer Wagen

**061507**  
29.4 kg  
⊗ 112 x 42 x 14 cm / 30 kg

max 150 kg  
100 cm  
135 - 210 cm

**MADE IN HIGH QUALITY POLAND**

**2 IN 1 MECHANICS CREEPER**  
- Chariot de visite 3 en 1 - Werkstatt-Rollliege

**079861**  
102 x 40 x 14 cm  
40 x 13 x 63 cm - 7.6 kg

**1** **NEW** **2**

**080041**  
7.3 kg  
⊗ 100 x 39.5 x 19 cm / 8.1 kg

**NEW**  
850 mm  
490 mm  
1180 mm  
300 mm

**150 kg ALU**

**FOLDING STEP STOOL - Marche pied (Aluminium)**  
- Arbeitspodest klappbar

**057562**  
7.9 kg  
⊗ 102 x 39 x 19 cm / 8.5 kg

960 mm  
475 mm  
385 mm

**150 kg ALU**

**058552**  
↓ 113 x 41 x 16 cm / 16 kg  
⊗ 117 x 42 x 17 cm / 17 kg

1090 > 1750 mm  
520 > 900 mm  
300 mm

**150 kg ALU**

**Complete carbody workstation**  
080119

included



Workstation only  
076143

**MOBILE WORKSTATION**  
- Table de travail mobile



**WORKSTATION 3 SHELVES**  
- Servante 3 plateaux



**HEAT COVER - Couverture anti-chaueur - Hitzschutzdecke - Manta anti-calor - Protecção anti-aquecimento**



**SET OF 2 MAGNETS**  
- Jeu de 2 aimants  
- Schweißmagnet

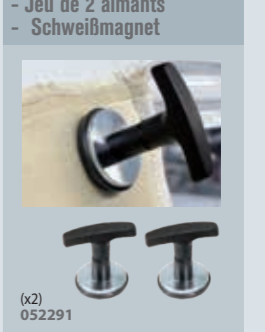

**MAGNETIC COVER - Couverture magnétique - Magnetschutzdecke**



**RIDEAU DE SOUDAGE - Welding curtain and frame - Schweißerschutzwand**



**RESPIRATORY MASKS - Masques respiratoires - Atemschutzmaske - Máscaras respiratorias**



**PROTECTION GOGGLES**  
- Lunettes de protection - Schutzbrillen



**GLOVES - Gants - Handschuhe - Guantes**



**MULTI-USE LEATHER APRON**  
- Tablier cuir multi-usage  
- Delantal de cuero multi-uso  
- Mehrzweck-Lederschürze



**EQUIPMENT FOR OPERATIONS ON ELECTRIC AND HYBRID VEHICLES** - Équipements pour opérations sur véhicules électriques & hybrides - Ausrüstung für den Betrieb von Elektro- und Hybridfahrzeugen

**FACE SHIELD WITH HEADBAND**  
- ÉCRAN FACIAL AVEC SERRE-TÊTE  
068018



**INSULATING GLOVES (T10)**  
- GANTS ISOLANTS (T10)  
068025



**25 pieces insulated tools 1000V - Coffret de 25 outils isolés 1000V**  
- Box mit 25 isolierten Werkzeugen 1000V  
066489

7/8/10/12/14/15/17/19/22 mm sockets - Douilles 7/8/10/12/14/15/17/19/22 mm	x 9
175 mm universal pliers in chrome vanadium - Pince universelle de 175 mm en chrome vanadium	x 1
Cutting pliers 150 mm in chrome vanadium - Pince coupante 150 mm en chrome vanadium	x 1
3/8" ratchet - Cluqjet en 3/8"	x 1
Extension 100 mm - Rallonge 100 mm	x 1
T-handle - Poignée en T	x 1
Open ended wrenches 7/8/10/12/14/17 mm - Clés plates à fourches 7/8/10/12/14/17 mm	x 6
Cable knife - Couteau pour câble	x 1
Phillips PhH1x100/PhH2x100 mm screwdriver - Tournevis Phillips PhH1x100/PhH2x100 mm	x 2
Flat screwdriver 5.5x125 / 4x100 mm - Tournevis plats 5.5x125/4x100 mm	x 2



**Kit for marking the area of intervention**  
- Kit pour le balisage de la zone d'intervention  
- Kennzeichnungsset für Hochvolt-Bereiche  
064409

Red and white warning pole - Balise de signalisation rouge et blanche	x 4
Red and white bounding line - Chaîne de délimitation rouge et blanche	x 1
Sign board "Danger, working area EHV" - Pancarte de signalisation "Danger, zone de travail VEH"	x 2



**TROUSER** - Pantalon - Hose



EN ISO 11611 Class 2-A1 & A2	98% cotton, 2% antistatic
EN ISO 11612 A1+A2-B1-C1-E3-F1	S (40/42) 046368
EN 1149-5	M (44/46) 046375
IEC 61482-2 Class 1-4kA	L (48/50) 046382
EN 14404 +A1 Type 2	XL (52/54) 046399
	XXL (56/58) 046412

**JACKET** - Veste - Jacke



IEC 61482-2 Class 1-4kA	98% cotton, 2% antistatic
EN ISO 11612 A1+A2-B1-C1-E3-F1	S (40/42) 046313
EN 14404 +A1 Type 2	M (44/46) 046320
EN ISO 11611 Class 2-A1 & A2	L (48/50) 046337
EN 1149-5	XL (52/54) 046344
	XXL (56/58) 046351



★★★★★ **THEY TRUST US** ★★★★★

ILS NOUS FONT CONFIANCE

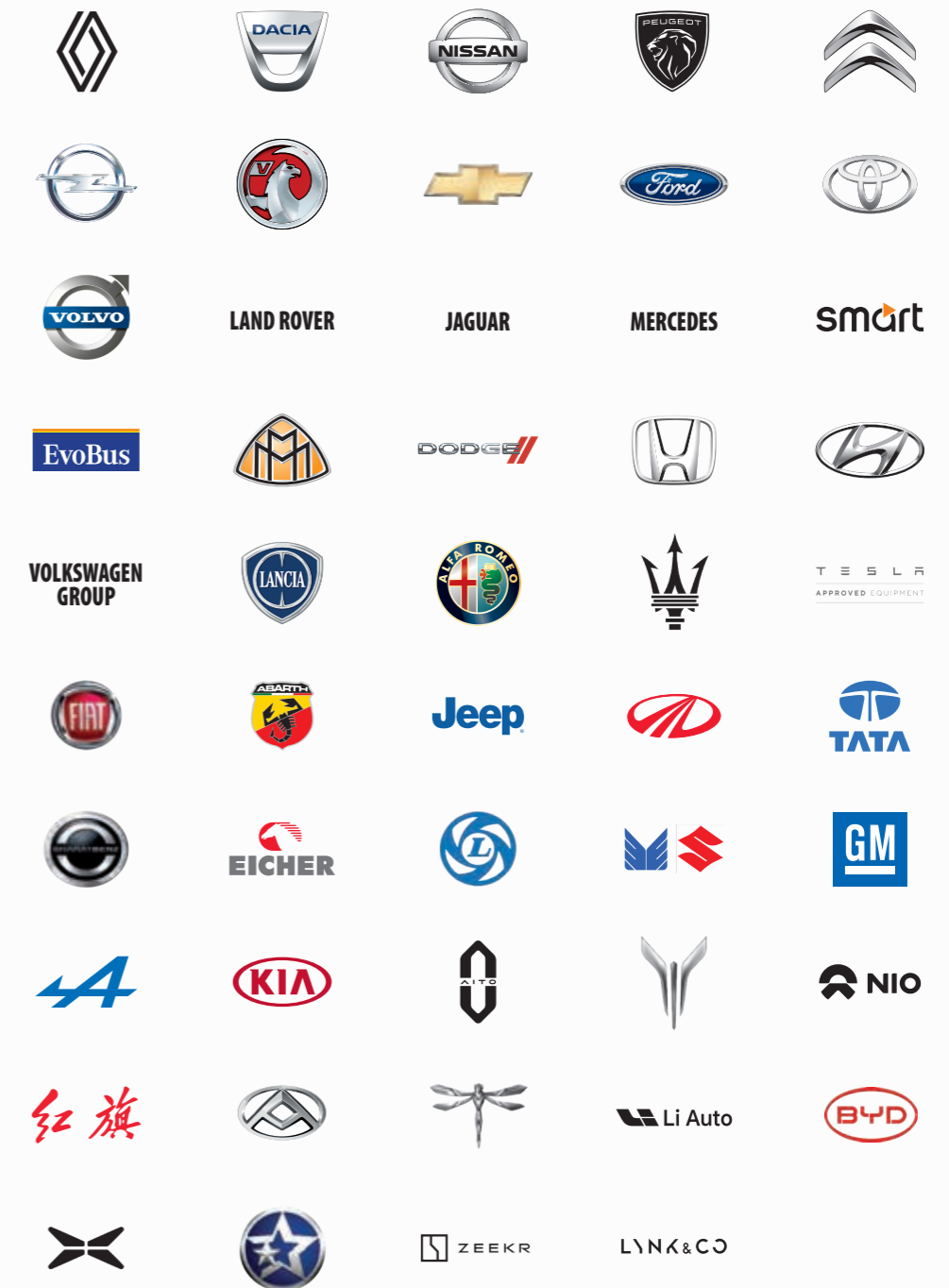



INVEST IN THE FUTURE



French manufacturer  
since 1964

2  
0  
2  
3  
B

# Car Body Welding Systems

Catalogue Carrosserie  
Catalogo Carrozzeria  
Karosserie-Schweißtechnik Katalog  
Catálogo de Soldadura para Carrocería



LinkedIn  
 Youtube  
 WeChat  
 Facebook  
 Instagram

[www.gys.fr](http://www.gys.fr)



## GYS FRANCE

### HEADQUARTERS

1 rue de la Croix des Landes  
CS 54159  
53941 Saint-Berthevin - Cedex  
Laval - France  
Tel +33 2 43 01 23 60  
E-mail [service.client@gys.fr](mailto:service.client@gys.fr)



ZI, 134 bd des Loges  
53941 Saint-Berthevin  
Laval - France

### LOGISTIC CENTER

2 Rue Jean Dausset  
53810 Changé - France  
Tel +33 2 43 01 54 33



## GYS GERMANY

Professor-Wieler  
Straße 11  
52070 Aachen  
Deutschland

Tel +49 241/189-23-710  
Fax +49 241/189-23-719  
E-mail [aachen@gys.fr](mailto:aachen@gys.fr)



## GYS UK

Unit 3 - Great Central Way  
Rugby - Warwickshire  
CV21 3XH  
United Kingdom

Tel +44 1926 338 609  
Fax +44 1926 429 764  
E-mail [uk@gys.fr](mailto:uk@gys.fr)



## GYS ITALIA

Vega - Parco Scientifico  
Tecnologico di Venezia  
Via Delle Industrie, 25/4  
30175 Marghera - VE  
Italia

Tel +39 041 53 21 565  
E-mail [italia@gys.fr](mailto:italia@gys.fr)



## GYS IBÉRICA

Avenida Pirineos 31  
Nave 9  
San Sebastian de los Reyes  
28703 Madrid  
España

Tel +34 917 409 790  
E-mail [iberica@gys.fr](mailto:iberica@gys.fr)



## GYS CHINA

Lot N°15  
6666 bd Songze  
201706 Qingpu  
Shanghai  
China

Tel +86 6221 4461  
Fax +86 5226 0067  
[www.gys-china.com.cn](http://www.gys-china.com.cn)  
E-mail  
[contact@gys-china.com.cn](mailto:contact@gys-china.com.cn)

## MARKETING

Podium de  
présentation  
- Display  
stand  
- Podest

**PODIUM 1**  
A : 45 cm  
B : 50 cm  
C : 50 cm  
063204

**PODIUM 2**  
A : 80 cm  
B : 50 cm  
C : 50 cm  
063211

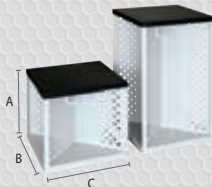

Oriflamme  
- Flag  
3 x 0,50 m  
098015



Barnum 3 x 3 m  
098022

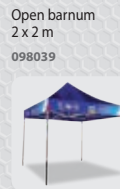

Open barnum  
2 x 2 m  
098039



Linéaire de vente  
avec 2 étagères  
- Retail display  
space  
with 2 shelves  
- Lochwandregal  
mit 2 Böden  
(machines not  
included)  
060784

Distributed by

