

AP 2/680 EB



PURCHASE CODES

AP 2/680 EB three-phase **3RAP2/680EB**

SPARE PARTS

Thermo-switch	1TRMO-90
Shock isolating mounting (4 pcs)	3KIT4232
Electric junction box	1CSSDSAREL
Cooling element	1RO01339
Electric fan	1VNA4D500DV
Frame	3CNAP2/680EB.1

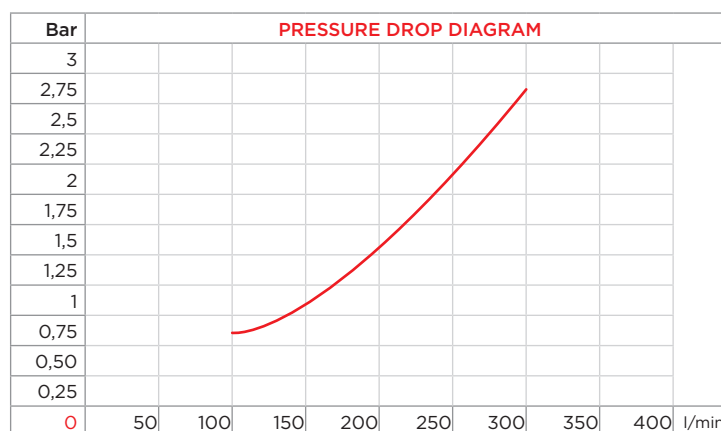
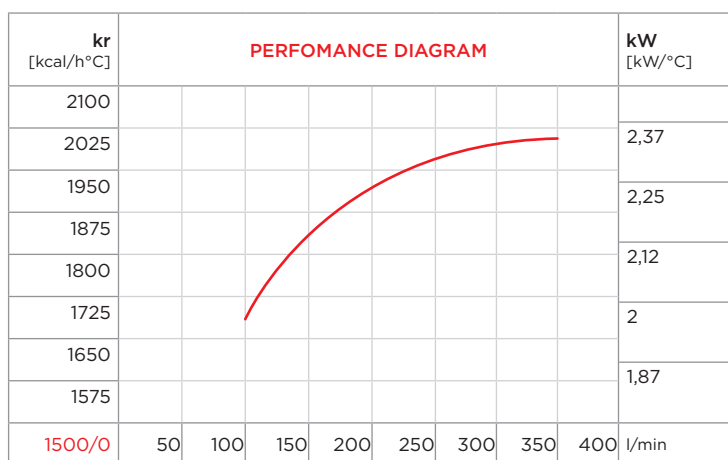

CORRECTION FACTOR

cSt	22	30	46	68	100	150	220
f	0,6	1	1,5	2,3	3,5	5	7

- Dimensions and technical characteristics are not binding

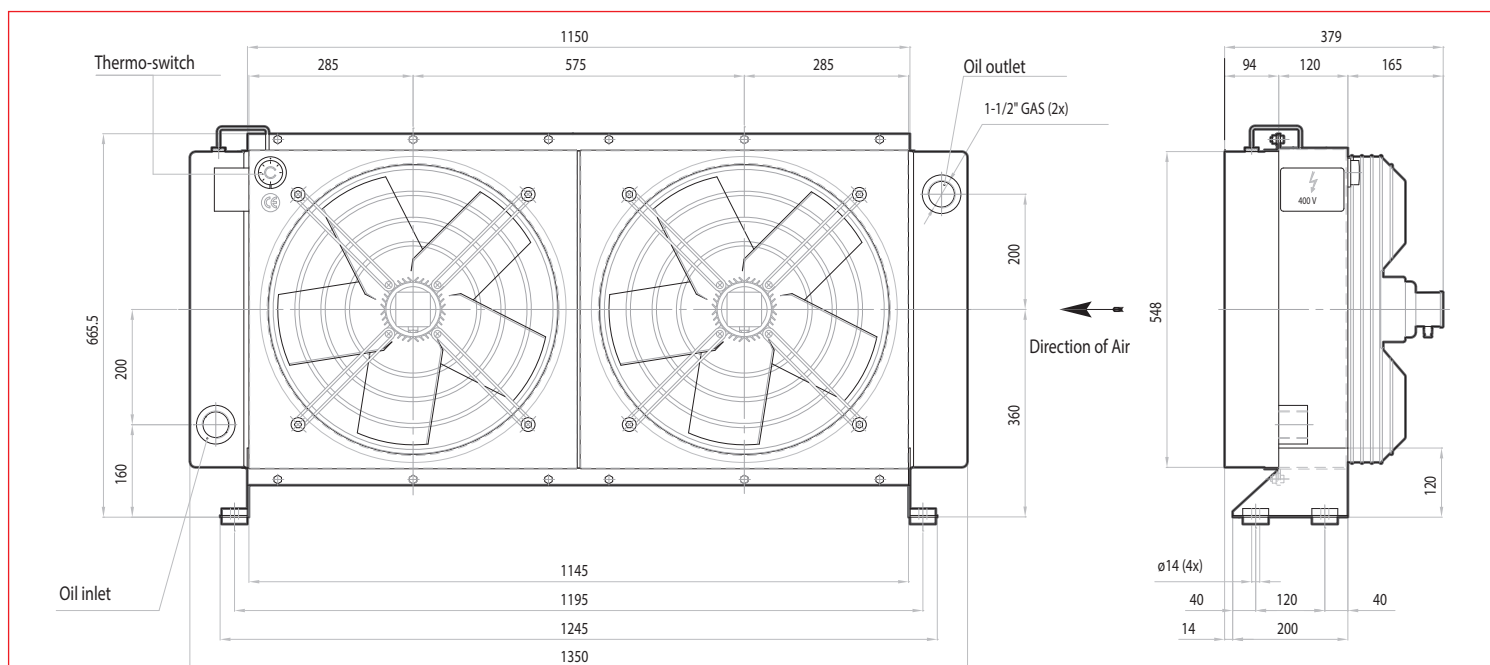

OIL FLOW	CAPACITY	VOLTAGE	FREQUENCY	POWER	CURRENT	AIR FLOW	PROTECTION	NOISE LEVEL	WEIGHT	Ø FAN
l/min	l	V	hz	W	A	m³/h	IP	dB(A)	kg	mm
100-300	28	230/400	50	2x 690	2x 2,34	2x 6.300	54	75	120	500
100-300	28	277/480	60	2x 1050	2x 2,72	2x 8.800	54	77	120	500