



Surface Miner Tools

CONSTRUCTION



SURFACE MINING

SOLID

Innovation Quality Service Value Application Expertise

The foundation for a successful surface mining operation is built on rock-steady reliability and progress. Kennametal, the world's leading tooling and services provider, proudly introduces SOLID, our solution-focused platform that yields new levels of performance and productivity. SOLID-engineered tools deliver in the most challenging conditions.

**For unmatched quality, value, innovation, and application expertise,
make Kennametal your SOLID choice!**



	Item	Order Number	Shank Dia. (mm)	Insert Dia. (mm)	Cutting Width								
					< 2500mm				> 2500mm				
					Cutting Conditions								
					Light	Medium	Heavy	Severe	Light	Medium	Heavy	Severe	
(0-20Mpa)	(20-50Mpa)	(50-80Mpa)	(> 80Mpa)	(0-20Mpa)	(20-50Mpa)	(50-80Mpa)	(> 80Mpa)						
TSCX / KSMX Series	TS19C X	4066765	38/30	17.5	•					•			
	TS31C X	4066872	38/30	19		•					•		
	TS32C X	4066821	38/30	22			•					•	
	TS30C X	4050638	38/30	25				•					•
	KSM42 LW1	Made to Order	42	17.5	•					•			
	KSM42 LW2	Made to Order	42	19		•					•		
	KSM42 LW3	Made to Order	42	22			•					•	
	KSM42 LW4	Made to Order	42	25				•					•
TS / KSM Series	TS19	1750422	38/30	17.5	•					•			
	TS31	2602450	38/30	19		•					•		
	TS32	2602451	38/30	22			•					•	
	TS30	2458404	38/30	25				•					•
	KSM42 S1	Made to Order	42	17.5	•					•			
	KSM42 S2	Made to Order	42	19		•					•		
	KSM42 S3	Made to Order	42	22			•					•	
	KSM42 S4	Made to Order	42	25				•					•
	KSM42 E1	Made to Order	42	17.5	•					•			
	KSM42 E2	Made to Order	42	19		•					•		
	KSM42 E3	Made to Order	42	22			•					•	
	KSM42 E4	Made to Order	42	25				•					•
U Series	U47GB	1010611	38/30	17.5	•					•			
	U47	1010742	38/30	19		•					•		
	U47HD	2222091	38/30	22			•					•	
	U47 52	1010429	38/30	25				•					•

Tool Recommendation:

Gold (best)
 Silver (better)
 Bronze (good)

Proven Reliability – Unparalleled Productivity.

No matter what your cutting conditions, equipment, or budget, we have just the tools you need!

GOLD

Our very best tools. Choose from this group when you want to save time and money long-term. Simply, these products – with their exceptionally durable bodies due to our proprietary hardness (**throughout the entire head**) process – deliver ultra-high performance over their lifetime versus any existing tools. That results in fewer teeth required, less downtime, and greatly reduced operating costs – thus helping you to become more productive and profitable! In addition, these tools incorporate our latest tip designs for maximum penetration and service. Plus, they have extra-wide collars for unmatched block protection.

**UNIQUE BODY HARDNESS PROCESS PROVIDES HIGH-PERFORMANCE OUTPUT OVER LIFE OF TOOL
• EXTRA-WIDE COLLARS SAFEGUARD BLOCKS • LATEST TIP DESIGNS FOR ULTIMATE PENETRATION**

SILVER

When your work calls for tools with *something beyond ordinary* performance, select from this series. Our unique carbide tip grades and designs, in conjunction with Kennametal's exceptional retention methods, yield superior results in even the most challenging applications!

EXTRA-WIDE COLLARS SAFEGUARD BLOCKS • LATEST TIP DESIGNS FOR ULTIMATE PENETRATION

BRONZE

Kennametal's Classic tools. Time-tested and proven in the field. For your everyday cutting requirements, no comparable products can provide the same efficiency!

LATEST TIP DESIGNS FOR ULTIMATE PENETRATION



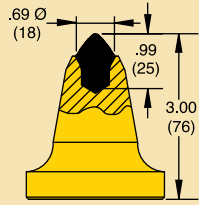
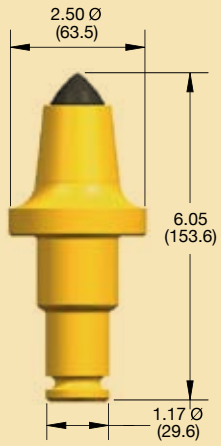

TS19C X
4066765

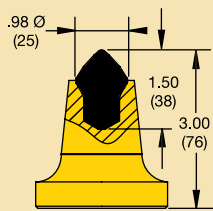

TS30C X
4050638

SILVER

TS Series
KR112 Retainer
 1011979



KSM Series
CM6H Retainer
 1777806



TS Series / KSM Series

TS Series

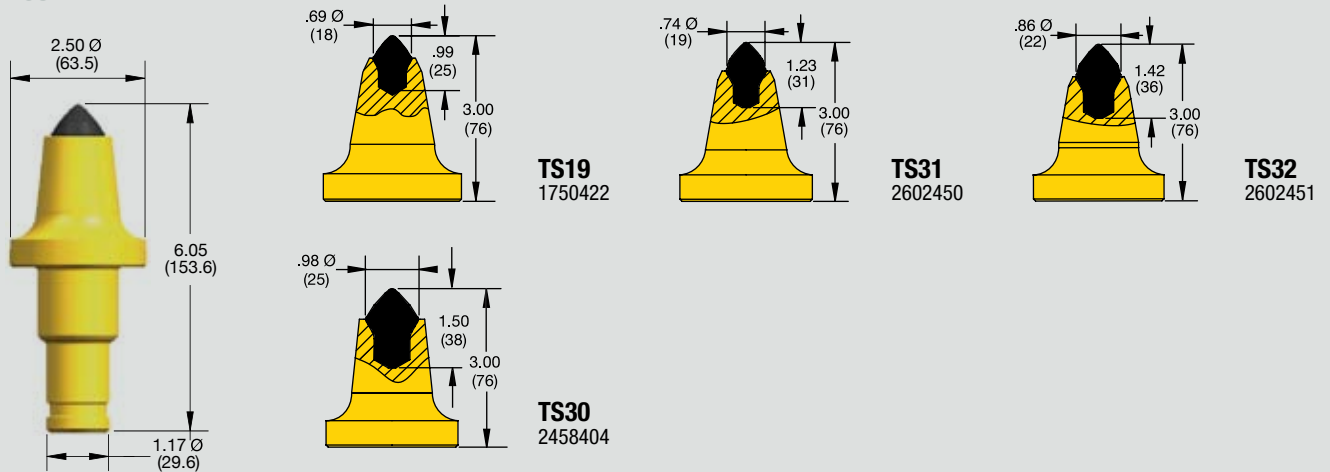

KSM Series

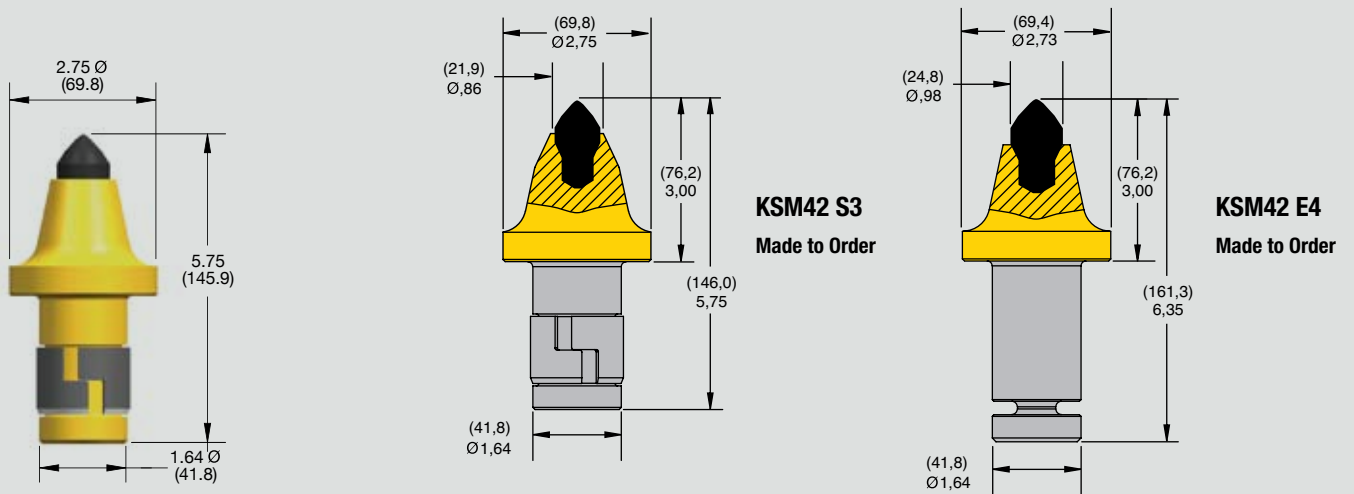

BRONZE

KR112 Retainer
1011979



U Series

U Series

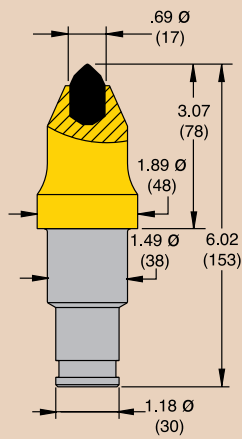

U47GB
1010611

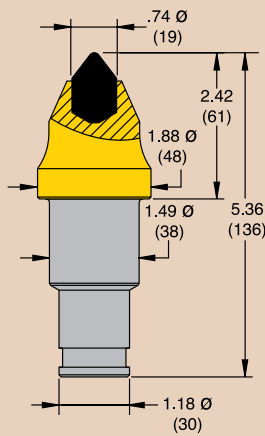

U47
1010742

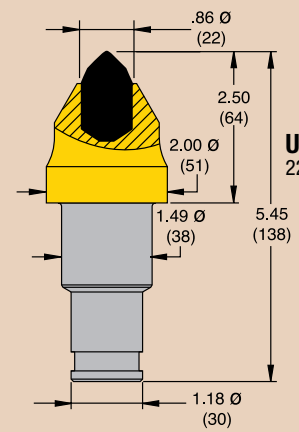

U47HD
2222091

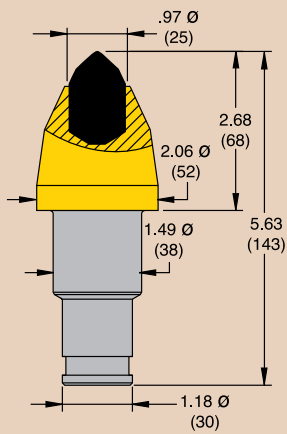

U47 52
1010429

Kennametal

The proven global leader in the design, manufacture, implementation, and sale of premium-quality tooling systems for underground and surface mining, road rehabilitation, aggregates production, and waste recycling!

United States / Canada / Mexico

Phone: 800.458.3608

Fax: 800.521.3319

mcs-na.service@kennametal.com

Germany / European Served Area

Phone: (49) 6172 737 498

Fax: (49) 6172 737 42 453

mcs-ag.service@kennametal.com

Poland / Slovakia / Baltics

Phone: (48) 32 47 89 100

Fax: (48) 32 47 89 112

Brazil / Latin America

Phone: (55) 19 3936 9200

Fax: (55) 19 3936 9201

Argentina

Phone: (54) 011 4719 0700

Fax: (54) 011 4719 6116

Chile

Phone: (56) 2 2641177

Fax: (001) 888 442 4964

China

Phone: (86) 400 6501 388

Fax: (86) 10 8561 5263

Japan

Phone: (81) 3 3820 2855

Fax: (81) 3 3820 2800

Korea

Phone: (82) 2 2109 6967

Fax: (82) 2 2109 6981

Thailand / Singapore / Vietnam / Philippines

Phone: (66) 2642 3455

Phone: (66) 2246 8025 – 32

Fax: (66) 2641 2736 – 8

Malaysia / Indonesia

Phone: (6) 03 5569 9080

Fax: (6) 03 5569 0080

India

Phone: (91) 80 2839 4321

Phone: (91) 80 2219 8444

Fax: (91) 80 2839 1300

bangalore.information@kennametal.com

Australia / New Zealand

Phone: (61) 7 3801 5844

Fax: (61) 7 3801 5826

sydney.service@kennametal.com

South Africa / Sub Saharan Area

Phone: (27) 11397 3540

Fax: (27) 11397 3222



Kennametal Inc.
1600 Technology Way
Latrobe, PA 15650
USA

WWW.KENNAMETAL.COM