



**THOMSON NEFF™**

# Lead Screws



## Offering smooth, precise, cost effective positioning, lead screws are the ideal solution for your application.

Thomson Neff precision lead screws are an excellent economical solution for your linear motion requirements. For more than 25 years, Thomson has designed and manufactured the highest quality lead screw assemblies in the industry. Our precision rolling process ensures accurate positioning to ,075mm/300mm and our PTFE coating process produces assemblies that have less drag torque and last longer.

Thomson provides a large array of standard plastic nut assemblies in anti-backlash or standard Supernut® designs. All of our standard plastic nut assemblies use an internally lubricated Acetal providing excellent lubricity and wear resistance with or without additional lubrication. With the introduction of our new unique patented zero backlash designs, Thomson provides assemblies with high axial stiffness, zero backlash and the absolute minimum drag torque to reduce motor requirements. These designs produce products that cost less, perform better and last longer. Both designs automatically adjust for wear ensuring zero backlash for the life of the nut.

**Thomson also provides engineering design services to aid in your design requirements producing a lead screw assembly to your specifications. Call Thomson today to discuss your application with one of our experienced application engineers.**

### Deliver Performance

Um eine genaue Positionierung zu gewährleisten, ist die Spielreduzierung von entscheidender Bedeutung. Auf dem Markt sind mehrere Arten von Vorspannvarianten, die alle eine nachgebende Vorspannung einsetzen. Da diese Mechanismen nur eine geringe Steifigkeit aufweisen, ist zum Beibehalten der Position eine hohe Vorspannung notwendig.

This results in high drag torque, shorter life and poor performance. System costs increase as a larger motor is required.

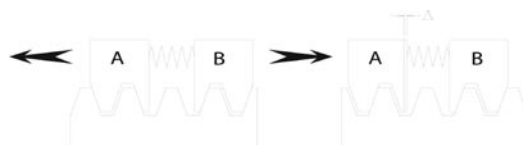

### The Solution is THOMSON NEFF

With the introduction of the Patented XC series nut with **ActiveCAM**, the highest axial stiffness with the absolute minimum drag torque is achieved. Utilising an extremely rigid stainless steel cam for biasing, axial stiffness is unsurpassed.

Axial play is removed without the need for high preload, resulting in the lowest drag torque possible.

### Self-Compensating

As wear occurs over time, the unique ActiveCAM mechanism automatically compensates without compromising stiffness, positional accuracy or affecting drag torque at any time.

US Patent #5839321 and one or more foreign counterparts.

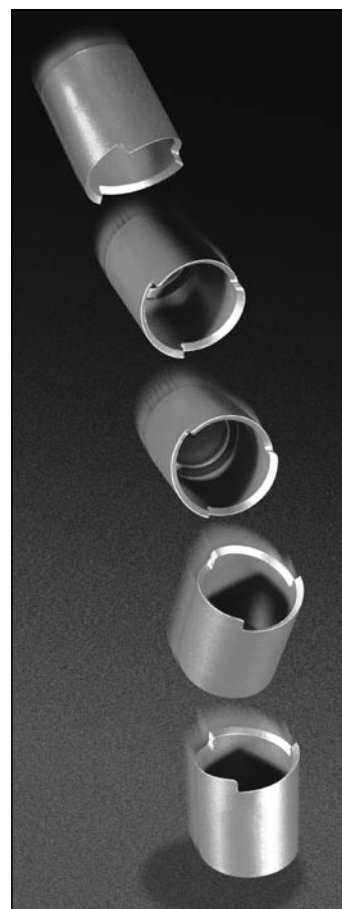
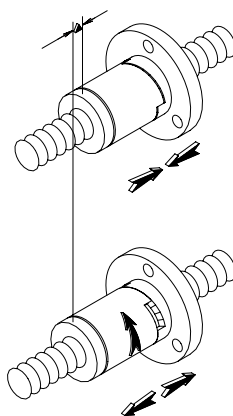

## Lead Screw Applications

Engraving Equipment

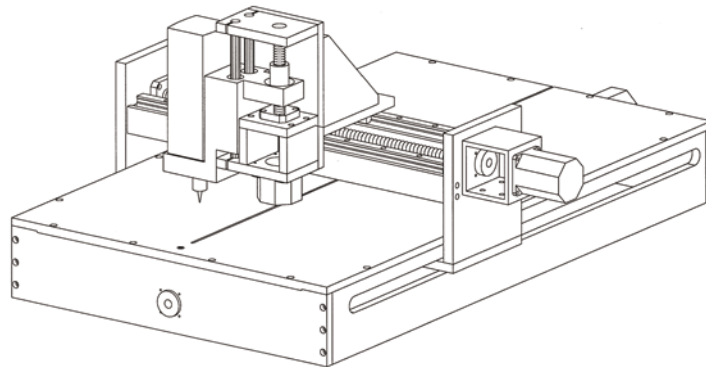

Medical Equipment

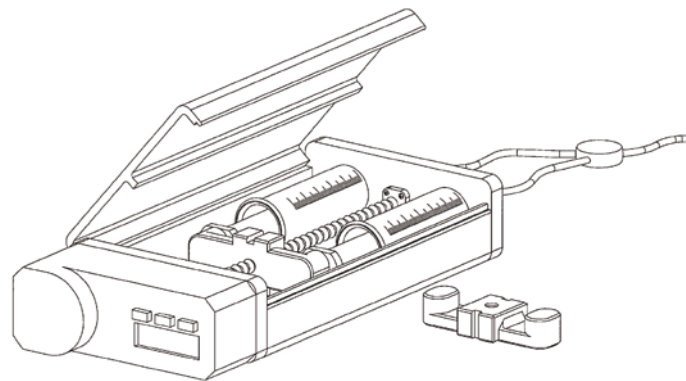

Semiconductor  
Manufacturing Equipment

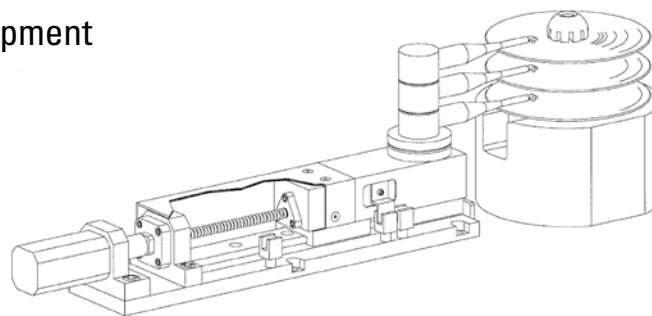

Laboratory Equipment

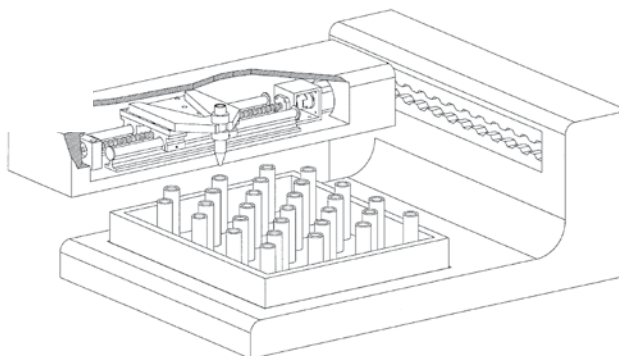

# Precision Lead Screws & Supernuts\*

## Features / Advantages

### Low Cost

Considerable savings when compared to ball screw assemblies.

### Variety

Large range of leads and diameters to match your requirements.

### Lubrication

Internally lubricated plastic nuts will operate without additional lubrication. However, TriGEL grease or dry film lubricant is recommended and will extend product life. See pages 13 and 14.

### Vibration and Noise

No ball recirculation vibration and often less audible noise compared to ball screws.

## Design Considerations

### Supernuts

provide a cost effective solution for moderate to light loads. For vertical applications, anti-backlash supernuts should be mounted with thread/flange on the bottom.

### Cantilevered Loads

Cantilevered loads that might cause a moment on the nut will cause premature failure.

### Critical Speed

Refer to critical speed chart on page 6.

### Column Loading

Refer to column loading chart on page 7.

### Self-Locking

Lead screws can be self locking at low leads. Generally, the lead of the screw should be more than 1/3 of the diameter to satisfactorily backdrive.

### Custom Capability

Option of custom components to fit into your design envelope.

### Non-Corrosive\*

Stainless Steel and internally lubricated acetal.

### Environment

Less susceptible to particulate contamination compared to ball screws.

### Lightweight

Less mass to move.

### Temperature

Ambient and friction generated heat are the primary causes of premature plastic nut failure. Observe the temperature limits below and discuss your design with our application engineers for continuous duty, high load and high speed applications. Thomson recommends bronze nuts for very high temperature environments or can aid in your selection of high temperature plastic for a custom assembly.

### Efficiency

Except at very high leads, efficiency increases as lead increases. Although the internally lubricated acetal provides excellent lubricity, Ball Screw Assemblies remain significantly more efficient than most Lead Screw designs. See page 12 for actual efficiencies.

### Length Limitations

Screw Diameter	Max Length
10 mm	1200 mm
12 - 16 mm	1800 mm
>16 mm	3600 mm

### Lead Accuracy

Standard Grade (SRA)	250 µm/300 mm
Precision Grade (SPR)	75 µm/300 mm

Assembly		Screws	Nuts**			
Maximum Temperature	Friction Coefficient	Material	Material	Tensile Strength	Water Absorption (24 HRS %)	Thermal Expansion Coefficient
82 °C	0,08 - 0,14	Stainless Steel*	Acetal with PTFE	55 MPa	0,15	9,7 x 10 <sup>-5</sup> m/m/C

\* 1.4301 (AISI 304) & 1.4305 (AISI 303) \*\* Other materials available on a custom basis.

## Useful Formulas for Lead Screw Assemblies

### TORQUE, ROTARY TO LINEAR

Driving the screw to translate the nut, or driving the nut to translate the screw.

$$\text{Torque (N-mm)} = \frac{\text{Load (N)} \times \text{Lead (mm)}}{2\pi \times \text{efficiency}}$$

### TORQUE, LINEAR TO ROTARY

Loading the nut to rotate the screw.

$$\text{Torque} = \frac{\text{Load} \times \text{Lead} \times \text{Efficiency}}{2\pi}$$

### EFFICIENCY

$$\% \text{ Efficiency} = \frac{\tan(\text{helix angle})}{\tan(\text{helix angle} + \arctan f)} \times 100$$

f = coefficient of friction

As a rule, assemblies that have an efficiency of 50% or more will backdrive. See page 12 for efficiencies. Efficiencies listed in catalogue computed at 0,1 friction coefficient.

## Critical Speed Limits Chart

Every screw shaft has a rotational speed limit. That is the point at which the rotational speed sets up excessive vibration. This critical point is modified by the type of end bearing support used.

To use this chart, determine the required RPM and the maximum length between bearing supports. Next, select one of the four types of end support shown below. The critical speed limit can be found by locating the point at which the RPM (horizontal lines) intersects with the unsupported screw length (vertical lines) as modified by the type of supports select below. We recommend operating at no more than 80% of the critical speed limit.

**Warning:** Curves for the screw diameters shown are based on the smallest root (minor) diameter of the standard screws within the nominal size range and truncated at the maximum ball nut rotational speed. **DO NOT EXCEED** this RPM regardless of screw length.

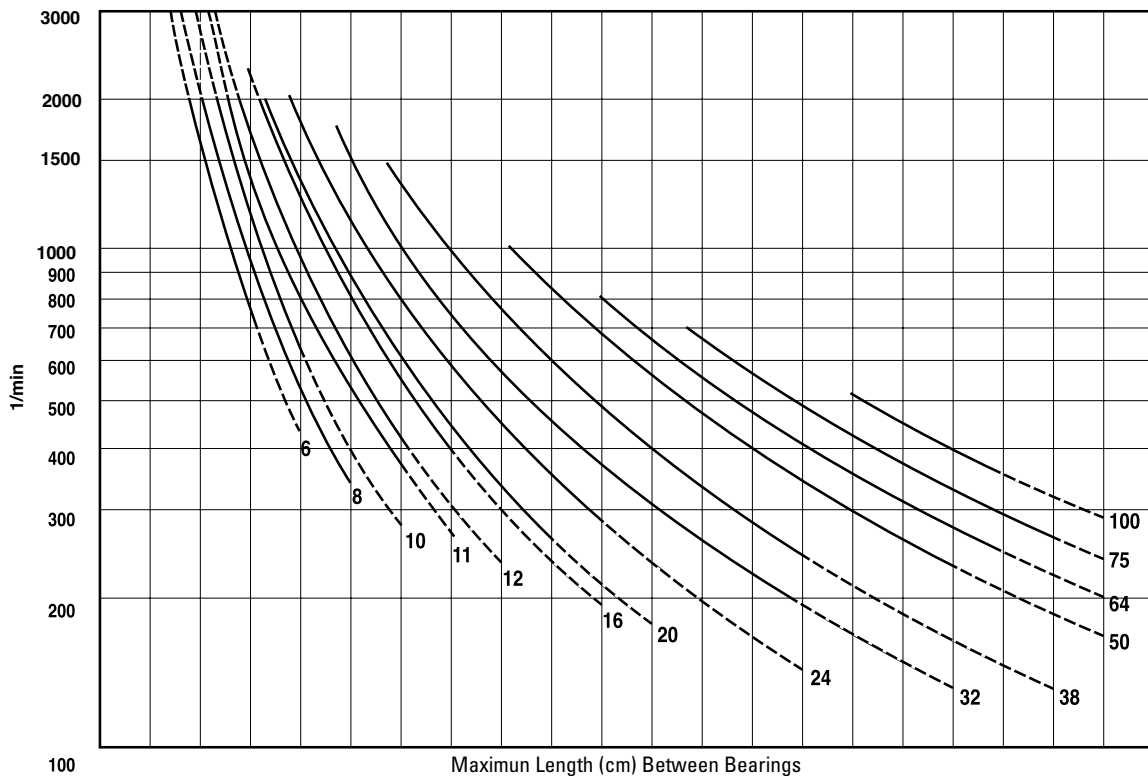

Fixed Free	150	300	460	610	760	910	1070	1220	1370	1520	1680	1830	1980	2130	2290	2440	2590	2740	3050	3200
Simple Simple	250	510	760	1020	1270	1520	1780	2030	2290	2540	2790	3050	3300	3560	3810	4060	4320	4570	4830	5080
Fixed Simple	300	610	910	1220	1550	1850	2160	2460	2770	3070	3380	3910	4010	4320	4620	4930	5230	5540	5840	6150
Fixed Fixed	380	760	1140	1520	1910	2290	2670	3020	3400	3780	4170	4550	4930	5310	5690	6070	6450	6830	7210	7570

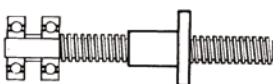

Fixed Free

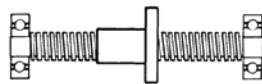

Simple Simple

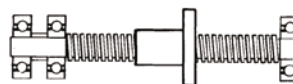

Fixed Simple

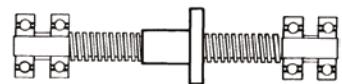

Fixed Fixed

## Column Loading Capacities Chart

Use the chart below to determine the Maximum Compression Load for Screw Shaft. Usually, screws operated in tension can handle loads up to the rated capacity of the nut, providing the screw length is within standard lengths. End supports have an effect on the load capacity of screws. The four standard variations are shown below with corresponding rating adjustments. Find the point of intersecting lines of load (horizontal) and length (vertical) to determine the minimum safe diameter of screw. If loads fall into dotted lines, consult factory.

**Warning: DO NOT EXCEED nut capacity.** Curves for the screw diameters shown are based on the smallest root (minor) diameter of the standard screws within the nominal size range.

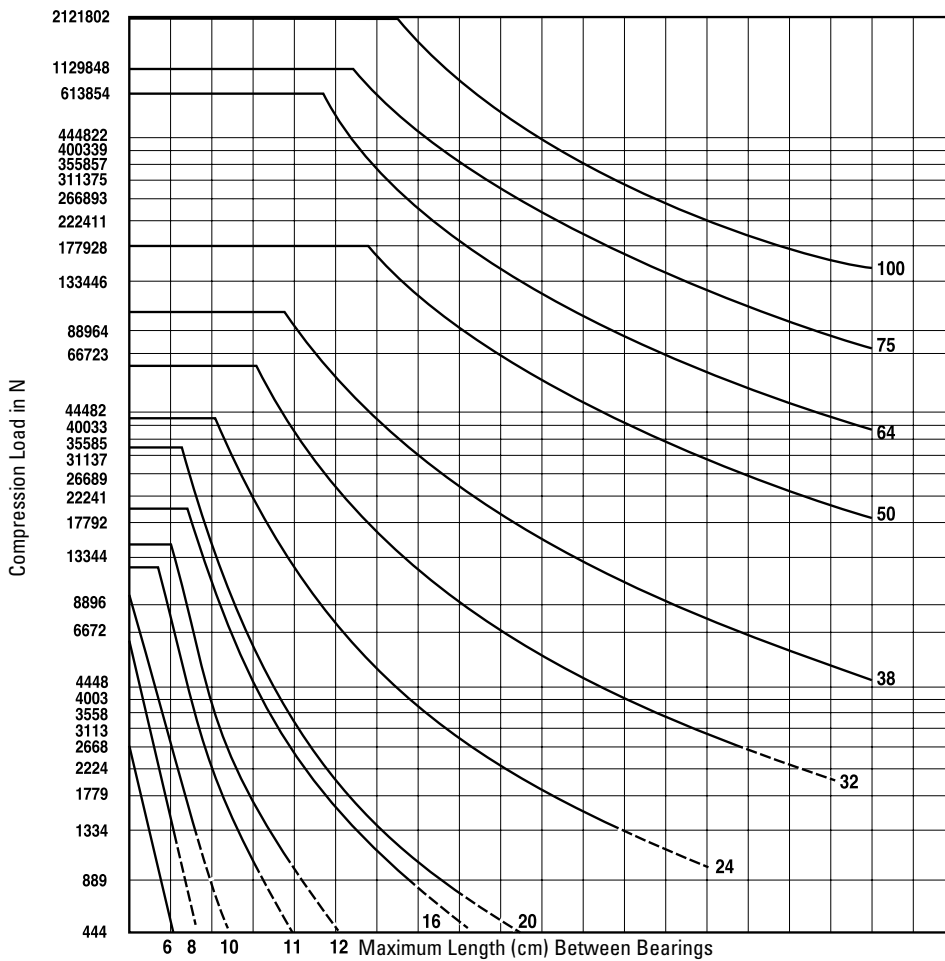

Fixed Free	130	250	380	510	640	760	890	1020	1140	1270	1400	1520	1650	1780	1910	2030	2160	2290	2410
Simple Simple	250	510	760	1020	1270	1520	1780	2030	2290	2540	2790	3050	3300	3560	3810	4060	4320	4570	4830
Fixed Simple	360	710	1070	1450	1800	2160	2510	2870	3230	3580	3960	4320	4670	5030	5380	5740	6100	6480	6860
Fixed Fixed	510	1020	1520	2030	2540	3050	3560	4060	4570	5080	5590	6100	6600	7110	7620	8130	8640	9140	9650

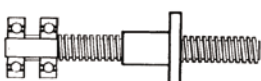

Fixed Free

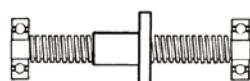

Simple Simple

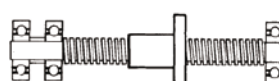

Fixed Simple

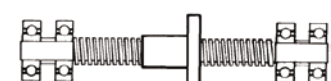

Fixed Fixed



Compression (Column) Load



Tension (Pulling) Load

## Lead Screw Product Summary

Series	Thomson Neff Precision Lead Screw
Lead accuracy	Standard - 250 µm / 300 mm Precision - 75 µm / 300 mm
Diameter	10 to 24 mm
Lead	2 to 45 mm
Backlash	,02 to ,25 mm (standard nut) Zero backlash available
Dynamic Load	Up to 1550 N
Max. Static Load	Up to 6675 N
Catalogue Pages	10 to 12

## Lead Screw Product Availability

### Metric

		Lead (mm)													
		2	3	4	5	6	8	10	12	15	16	20	25	35	45
Dia. (mm)	10	•	•		•	•		•				•		•	
	12		•	•	•	•		•		•			•		•
	16			•	•		•				•		•	•	
	20			•			•		•		•	•			•
	24				•										

• = stocked size

### Inch

Also available are our inch series lead screws.

Consult our website for further details at [www.thomsonlinear.com](http://www.thomsonlinear.com)

		Lead (Zoll)													
		0,050	0,063	0,083	0,100	0,125	0,167	0,200	0,250	0,375	0,500	0,800	1,000	1,200	2,000
Dia. (in)	3/8		•	•	•	•	•	•	•	•	•		•	•	
	7/16					•			•		•				
	1/2		•		•			•	•		•	•	•		
	5/8				•	•		•	•		•				
	3/4				•	•	•	•			•		•		•
	1				•	•		•	•		•		•		

**Note:** Miniature sizes also offered. Consult our website for further details at [www.thomsonlinear.com](http://www.thomsonlinear.com).

Custom diameters and leads per request.



## Ordering Information

Thomson engineers its lead screw thread to provide optimum performance. To ensure proper function, it is recommended that our nuts and screws be used only with mating Thomson Neff products. This is particularly important on our proprietary thread forms. If interchangeability is required, select a screw size from page 12 that conforms to the DIN standard.

It is recommended that you use a lubricant when operating a lead screw with a plastic nut. This will extend the life of the unit and increase the allowable operating load. (Note: load ratings in catalogue are calculated using a grease type lubricant.) See page 13 & 14 for lubrication options.

### Nut Part Number (See pages 10 and 11)

<b>Nut model number prefix</b> (Letters only - 2 or 3 characters))			<b>Screw size from table on page 12.</b> (Do not include accuracy prefix)

#### Example

X	C	B	10x2M
---	---	---	-------

**Note:** Make sure the nut you have selected is offered for use with the screw diameter you select. See the "Screw Series" column on pages 10 and 11 to verify.

### Screw Part Number (See page 12)

<b>Accuracy Prefix</b> (3 letter code for precision or standard accuracy)			<b>Screw Size</b> (specifies diameter and lead)	<b>Screw Length</b> (Please include units - mm preferred)
S	P	T	10x2M	150 mm

#### Example

Note that if the screw and nut have the same screw size suffix as shown in the examples above, the two components are properly specified to operate together.



## XC Series - The Performance Leader

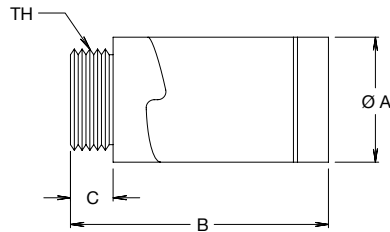

### Threaded Nut Type

Model #	Screw Series (mm)	Also Use w/Series (inch)	Dimensions				Design Load (N)	Drag Torque	
			A (mm)	B (mm) max	C (mm)	TH (mm)		Minimum (N-mm)	Maximum (N-mm)
CB3700	10	5/16, 3/8	20,8	47,6	6,4	M16 x 1,5	100	7	21
CB5000	12	7/16, 1/2	28,4	57,2	9,5	M25 x 1,5	550	7	21
CB6200	16	5/8	35,6	66,0	12,7	M30 x 1,5	775	14	42
CB7500	20	3/4	41,4	73,7	12,7	M35 x 1,5	1100	21	71
CB10000	24	1	47,8	76,2	15,2	M40 x 1,5	1550	35	71

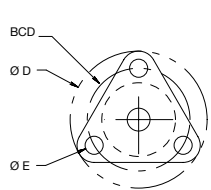

Nur XCF3700

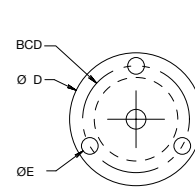
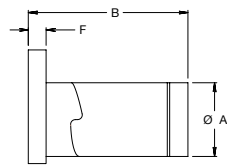

XCF5000, XCF6200

### Flange Nut Type

Model #	Screw Series (mm)	Also Use w/Series (inch)	Dimensions						Design Load (N)	Drag Torque	
			A (mm)	B (mm) max	D (mm)	E (mm)	F (mm)	BCD (mm)		Min. (N-mm)	Max. (N-mm)
CF3700	10	5/16, 3/8	20,8	47,6	38,1	5,1	5,1	28,6	100	7	21
CF5000	12	7/16, 1/2	28,4	57,2	44,5	5,6	7,6	35,5	550	7	21
CF6200	16	5/8	35,6	66,0	54,1	5,6	12,7	42,9	775	14	42

## AFT3700 - The OEM Solution

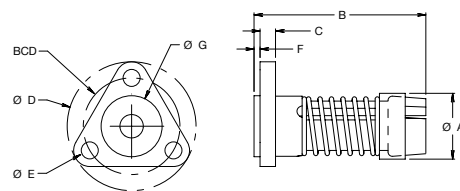

### Flange Nut Type

Model #	Screw Series (mm)	Also Use w/Series (inch)	Dimensions								Design Load (N)	Drag Torque	
			A (mm)	B (mm)	C (mm)	D (mm)	E (mm)	F (mm)	G (mm)	BCD (mm)		Min. (N-mm)	Max. (N-mm)
AFT3700	10	3/8, 7/16	19,6	50,8	5,1	38,1	5,1	1,5	18,0	28,6	45	14	35

See page 9 for ordering instructions

## SB Series - Compact Thread Mount Style

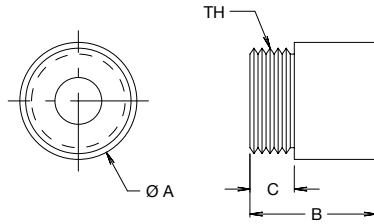
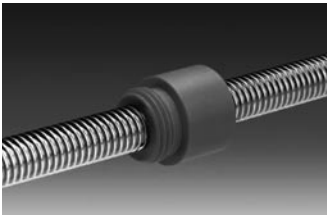

### Threaded Nut Type

Model #	Screw Series (mm)	Also Use w/Series (inch)	Dimensions				Design Load (N)	Max.Static Load (N)	Drag Torque
			A (mm)	B (mm)	C (mm)	TH (mm)			
SB3700	10	5/16, 3/8	19,1	19,1	6,4	M16 x 1,5	310	1550	No Preload
SB5000	12, 16	7/16, 1/2	25,4	25,4	9,5	M22 x 1,5	445	2225	
SB1000	20, 24	3/4, 1	38,1	38,1	12,7	M35 x 1,5	1335	6675	

## MTS Series - Easy Mount Flange Style

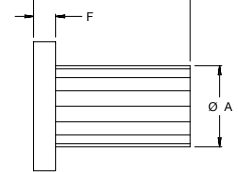
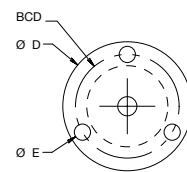
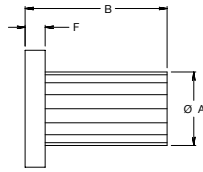
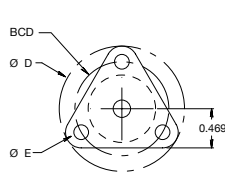

MTS3700 solo

MTS5000, MTS6200, MTS7500

### Flange Nut Type

Model #	Screw Series (mm)	Also Use w/Series (inch)	Dimensions						Design Load (N)	Drag Torque
			A (mm)	B (mm)	D (mm)	E (mm)	F (mm)	BCD (mm)		
MTS3700	10	3/8, 7/16	18,0	38,1	38,1	5,1	5,1	28,6	325	No Preload
MTS5000	12	1/2	19,1	38,1	38,1	5,1	6,4	28,6	550	
MTS6200	16	5/8	22,4	41,4	38,1	5,1	7,6	30,2	775	
MTS7500	20	3/4	28,6	44,5	50,8	5,1	7,6	36,5	1200	

See page 9 for ordering instructions

**Note:** Design load is the recommended maximum operating load with lubrication at room temperature, 50% duty cycle, and 500 RPM. Increasing the RPM will decrease the maximum allowable operating load. At 1,000 RPM, the operating load is approximately 1/2 of the rated design load.

## Precision Metric Screws

Precision rolled lead screws offer a burnished finish for maximum efficiency and lowest wear. All screws are stainless steel to provide corrosion resistance and a bright finish. SPT and SRT screws conform to DIN 103 while SPR and SRA screws have optimised thread forms for maximum performance.



Shaft Diameter (mm)	Lead (mm)	Part Number			Root Diameter (mm)	Efficiency @ .1 Friction Coefficient (%)
		Precision Accuracy Prefix	Standard Accuracy Prefix	Size		
10	2*	SPT	SRT	10 x 2M	7,4	42
	3^	SPT	SRT	10 x 3M	6,4	53
	5	SPR	SRA	2-10 x 2,5M	7,1	64
	6	SPR	SRA	4-10 x 1,5M	8,2	66
	10	SPR	SRA	5-10 x 2M	7,5	76
	20	-	SRA	6-10 x 3,3M	8,4	81
	35	-	SRA	10-10 x 3,5M	7,4	81
12	3*	SPT	SRT	12 x 3M	8,0	48
	4	SPR	SRA	2-12 x 2M	9,2	54
	5^	SPT	SRT	2-12 x 2,5M	8,9	59
	6	SPR	SRA	3-12 x 2M	9,1	63
	10^	SPT	SRT	4-12 x 2,5M	8,9	73
	15	SPR	SRA	6-12 x 2,5M	8,7	78
	25	-	SRA	10-12 x 2,5M	9,2	82
	45	-	SRA	15-12 x 3M	9,6	81
16	4*	SPT	SRT	16 x 4M	11,3	48
	5	SPR	SRA	2-16 x 2,5M	12,2	52
	8	SPR	SRA	4-16 x 2M	13,0	63
	16	SPR	SRA	7-16 x 2,3M	12,6	75
	25	-	SRA	5-16 x 5M	11,5	80
	35	-	SRA	7-16 x 5M	12,2	82
	45	-	SRA	9-16 x 5M	12,2	82
20	4*	SPT	SRT	20 x 4M	15,3	42
	8	SPR	SRA	2-20 x 4M	14,8	59
	12	SPR	SRA	3-20 x 4M	15,0	67
	16	SPR	SRA	4-20 x 4M	15,0	72
	20	-	SRA	5-20 x 4M	15,0	76
	45	-	SRA	9-20 x 5M	15,8	82
24	5*	SPT	SRT	24 x 5M	18,5	42

\*Conforms to DIN 103 parts 1 & 2. Tolerance grade 7e.

^Conforms to DIN 103 part 1, not defined in parts 2 & 3

See page 5 for maximum available screw lengths

See page 9 for ordering instructions

## Lubrication



### Overview

We offer a full complement of lubricants including our low vapour pressure greases for clean room and vacuum application. The TriGel line is specifically formulated to offer a lubrication solution for a wide range of linear motion applications. Choose the appropriate gel for your requirements and get the utmost performance out of your Thomson products.

## Lubrication Selection Chart for Ball & Lead Screw Assemblies

Thomson Neff	TriGel-300S	TriGel-450R	TriGel-600SM	TriGel-1200SC	TriGel-1800RC
Application	Lead Screws, Supernuts, Plastic Nuts	Ball Screws, Linear Bearings	Bronze Nuts	Lead Screws, Plastic Nuts, Clean Room, High Vacuum	Ball Screws, Linear Bearings, Bronze Nuts, Clean Room, Vacuum
Maximum Temperature	200 °C (392 °F)	125 °C (257 °F)	125 °C (257 °F)	250 °C (482 °F)	125 °C (257 °F)
Mechanism	Plastic on Plastic or Metal	Metal on Metal	Metal on Metal Bronze on Steel	Plastic on Metal Combination	Metal on Metal
Mechanical Load	Light	Moderate	Moderate to Heavy	Light to Moderate	Moderate
Very Low Torque Variation over Temperature	Yes	—	—	Yes	—
Very Low Starting Torque	Yes	Yes	—	Yes	Yes
Compatibility with Reactive Chemicals	Not recommended w/o OEM testing	Not recommended w/o OEM testing	Not recommended w/o OEM testing	Usually OK	Not recommended w/o OEM testing
Compatibility with Plastics and Elastomers	May cause silicon rubber seals to swell	May cause EPDM seals to swell	May cause EPDM seals to swell	Usually OK	May cause EPDM seals to swell
Clean Room Use	Not recommended	Not recommended	Not recommended	Usually OK	Usually OK
High Vacuum Use	Not recommended	Not recommended	Not recommended	Usually OK	Usually OK
Vapor Pressure (25°C)	Varies with lot	Varies with lot	Varies with lot	1 x 10 <sup>-6</sup> Pa	0,5 x 10 <sup>-6</sup> Pa
Packaging 10-cc-Syringe 0,45-kg-Tube	<b>TriGel-300S</b> <b>TriGel-300S-1</b>	7832867/ <b>TriGel-450R</b> 7832868/ <b>TriGel-450R-1</b>	0,1-kg-Tube/ <b>TriGel-600SM</b>	<b>TriGel-1200SC</b> n.z.	7832869/ <b>TriGel-1800RC</b>

\* Maximum temperature for continuous exposure. Higher surge temperatures may be permissible but should be validated in the actual end use by the OEM. Low temperature limits are -15°C or lower. Consult Thomson for specifics.

## PTFE Dry Film Lubricant

Formulated for plastic on metal lead screw applications



PTFE coating is a dry film which creates a lubrication barrier between a metal substrate and a polymer bushing or lead nut. It can in some cases eliminate the need for an additional gel type lubricant which must be re-applied. It is well suited for use with our SuperNut line of plastic nuts and stainless steel lead screws. Lubrication maintenance intervals can be eliminated and the coating does not attract particulate like a gel lubricant. Gel lubricants can provide lower friction coefficients than dry film lubricants but must be maintained to prevent performance degradation. PTFE coating provides an attractive and clean\* alternative to gels and oils.

### Typical Properties

Type:	Bonded Solid Film Lubricant
Purpose:	Increased Lubricity, Decreased Friction & Wear
Appearance:	Black Coating
Thickness:	Approx. 13 – 25 micron
Active Lubricant:	Polytetrafluoroethylene
Friction Coefficient:	0,06 to 0,12
Temperature Operating Range:	-250° to 290° C
Resistance to Acids:	Excellent
Resistance to Bases:	Very Good
Resistance to Solvents:	Excellent

\*Some particulate will be generated as a result of wear between nut and screw. Screw may begin to show signs of “polishing” over time. This does not necessarily indicate failure.

## Application Data Information Sheet

Name: \_\_\_\_\_

Titel/Dept: \_\_\_\_\_

Company Name: \_\_\_\_\_

Address: \_\_\_\_\_

\_\_\_\_\_ Country: \_\_\_\_\_

Phone: \_\_\_\_\_ Fax: \_\_\_\_\_

E-mail: \_\_\_\_\_

1. What is your LOAD? \_\_\_\_\_  
 Newton    Kilograms    Pounds  
 Other \_\_\_\_\_  
(please describe)
2. Is your MOTION    Horizontal or    Vertical
3. What is the length of STROKE? \_\_\_\_\_  
 m    mm    in  
 Other \_\_\_\_\_  
(please describe)
4. What is the SPEED? \_\_\_\_\_  
 m    mm    in per    second    min
5. ACCURACY requirements:  
 0,25 mm / 300 mm  
 0,075 mm / 300 mm    Other \_\_\_\_\_  
(please describe)
6. BACKLASH requirements:  
 0    0,25mm  
 0,05mm    Other \_\_\_\_\_  
(please describe)
7. BEARING SUPPORT requirements:  
 (see page 6)    Lagerfall 1    Lagerfall 2  
 Lagerfall 3    Lagerfall 4 \_\_\_\_\_  
(please describe)
8. Quantity required \_\_\_\_\_ per    Month    Year    Other \_\_\_\_\_  
(please describe)

Additional information/comments (describe environment and whether grease lubricant is allowed):

**USA, CANADA and MEXICO**

Thomson  
203A West Rock Road  
Radford, VA 24141, USA  
Phone: 1-540-633-3549  
Fax: 1-540-633-0294  
E-mail: thomson@thomsonlinear.com  
Literature: literature.thomsonlinear.com

**EUROPE****United Kingdom**

Thomson  
Office 9, The Barns  
Caddsdawn Business Park  
Bideford  
Devon, EX39 3BT  
Phone: +44 (0) 1271 334 500  
E-mail: sales.uk@thomsonlinear.com

**Germany**

Thomson  
Nürtinger Straße 70  
72649 Wolfschlugen  
Phone: +49 (0) 7022 504 0  
Fax: +49 (0) 7022 504 405  
E-mail: sales.germany@thomsonlinear.com

**France**

Thomson  
Phone: +33 (0) 243 50 03 30  
Fax: +33 (0) 243 50 03 39  
E-mail: sales.france@thomsonlinear.com

**Italy**

Thomson  
Largo Brughetti  
20030 Bovisio Masciago  
Phone: +39 0362 594260  
Fax: +39 0362 594263  
E-mail: sales.italy@thomsonlinear.com

**Spain**

Thomson  
E-mail: sales.esm@thomsonlinear.com

**Sweden**

Thomson  
Estridsväg 10  
29109 Kristianstad  
Phone: +46 (0) 44 24 67 00  
Fax: +46 (0) 44 24 40 85  
E-mail: sales.scandinavia@thomsonlinear.com

**ASIA****Asia Pacific**

Thomson  
E-mail: sales.apac@thomsonlinear.com

**China**

Thomson  
Rm 2205, Scitech Tower  
22 Jianguomen Wai Street  
Beijing 100004  
Phone: +86 400 6661 802  
Fax: +86 10 6515 0263  
E-mail: sales.china@thomsonlinear.com

**India**

Thomson  
c/o Fluke Technologies Pvt. Ltd.  
#424, Deodhar Center,  
Marol Maroshi Road,  
Andheri – E, Mumbai – 400059 India  
Phone: +91 22 29207641  
E-mail: sales.india@thomsonlinear.com

**Japan**

Thomson  
Minami-Kaneden 2-12-23, Suita  
Osaka 564-0044 Japan  
Phone: +81-6-6386-8001  
Fax: +81-6-6386-5022  
E-mail: csjapan@scgap.com

**Korea**

Thomson  
F7 Ilsong Bldg, 157-37  
Samsung-dong, Kangnam-gu,  
Seoul, Korea (135-090)  
Phone: +82 2 6917 5049  
Fax: +82 2 528 1456  
E-mail: sales.korea@thomsonlinear.com

**SOUTH AMERICA****Brazil**

Thomson  
Av. Tamboré, 1077  
Barueri, SP – 06460-000  
Phone: +55 (11) 3616-0191  
Fax: +55 (11) 3611-1982  
E-mail: sales.brasil@thomsonlinear.com